



DA VINCI
TUSCANY
Collection





Glass Design è un'eccellenza Italiana nella produzione e nel design di lavabi e complementi d'arredo bagno. *Glass Design is an Italian excellence in the production and design of bathroom washbasins and interior decoration furnishings.*

Situata a Vinci, cuore della Toscana e città di "Leonardo da Vinci", Glass Design è stata fondata nel 1984 dalla famiglia Borsellini, dopo una pluriennale esperienza nella manifattura del vetro artistico. *Located in Vinci, in the heart of Tuscany and native town of "Leonardo da Vinci", Glass Design was founded in 1984 by the Borsellini family, further to a long tradition in manufacturing artistic glass.*

Utilizzando materiali tecnologicamente avanzati, come il Silicio o l'Inox e, lavorando ad arte su materiali tradizionali, come il cristallo molato o il vetro artistico, Glass Design contribuisce alla creazione di un nuovo stile dove l'accessorio, curato nei minimi dettagli, diventa il soggetto principale dell'ambiente, un vero prodotto "moda", apprezzato nel mondo ed esportato in più di 60 paesi. *Both by using technologically advanced materials such as stainless steel or silicone, and by working in an artistic way with traditional materials like the formed 24%pb crystal and the artisan glass, the company Glass Design contributes to the creation of a new style, where even the accessory is addressed in all details, becoming the main subject of the environment, a true "fashion" product, highly appreciated in the world and exported to more than 60 countries.*

Oltre 200 artigiani Toscani e una quindicina di vetrai muranesi appartengono alla filiera produttiva aziendale, permettendo di adattare ogni prodotto ad esigenze e richieste specifiche del cliente, con infinite personalizzazioni realizzando così, prodotti unici ed esclusivi. *Over 200 Tuscan artisans and more than 15 glassmakers of Murano work within the company's production chain, enabling the customization of each product to suit individual needs and specific requirements, in order to create unique and exclusive products.*

FREESTANDING
Solutions

12/67



Sculture senza tempo
piene di contenuti creativi e culturali.
*Timeless sculptures
of creative and cultural contents.*

IN-OUT
Solutions

68/139



Emergenti sensazioni di design e lusso.
Emerging feelings of design and luxury.

MOBILI
Furniture Solutions

140/207



Affascinanti come i concetti che li ispirano.
As fascinating as the concepts that inspire them.

DOCCIA
Shower trays Solutions

208/263



Coordinati per una seduzione totale.
Coordinated for total seduction.

Accessori &
Complementi
Accessories &
Complements
268/275

Materiali
Materials
Certificazioni
Certifications
276/281

FREESTANDING
Solutions



Isola
14-17



Spazio
18



Tempo
20



FLOWer **E**volution
22-25



FLOWer **s**tyle
26-29



Roma **A**LTO
30-34



Roma **S**TYLE
31-35



Tom **T**om
36



Tom **T**om 2
38



Tommy
40



Tommy **M**etropole
42



Mini **B**ATHTUB
44-47



Mont **B**lanc
48-51



Paradiso
52-55



*S*pecifiche
Data sheet

58-67

IN-**O**UT
Solutions

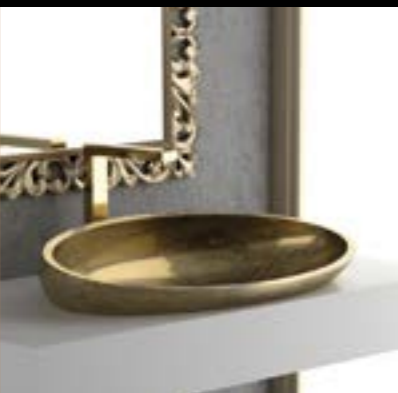

Kool XL FL
70



Circus 43 FL
72



Circus 50 FL
74



Open
76



Italy FL
78



Riv FL
80



Kosta **I**
82



Kosta **I**I
84



Rx
86



VOLcano FL
88



Play FL
90



Ellisse FL small - large - xl
92



Tondo FL
94



Naxos FL
96



Play **I**n
98

Specifiche
Data sheet

Top porta-lavabo
Cassettiere sospese
Colonne sospese

SINTESI

Top for washbasin
Suspended drawer element
Suspended tall cabinet

SOTTO

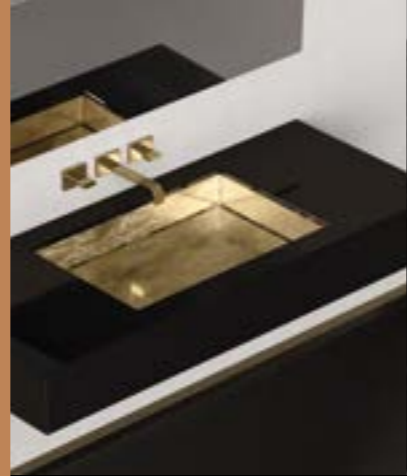

Blade sotto
114

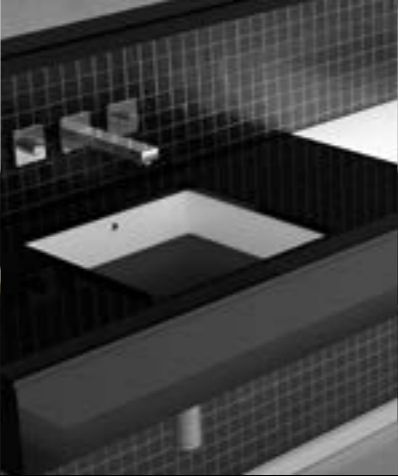

Four sotto
116



Rho sotto
118



Flou sotto
120



Bolla sotto
122

102-107

108-111



Yacht sotto
124

126-137

Specifiche
Data sheet

MOBILI Furniture Solutions

MONNALISA



Monnalisa Prestige
144-149



Monnalisa Florence
150-153



Monnalisa Class
154-157

MISURA



Misura UNO
160-163



Misura DUE
164-167



Misura TRE
168-171

LEONARDO



Cubus
174-179



Canto SMALL
180-185



Canto XL
186-189



Koin MEDIO
190-195



Koin XL
196-201



Lumiere
202-205



Musa
206

DOCCIA
Shower trays Solutions

NATURA
LUX



Natura LUX Gold

212-217



Natura LUX Silver



218

Specifiche
Data sheet

220

TERRA
LUX



Terra LUX Silver

224-229



Terra LUX Gold

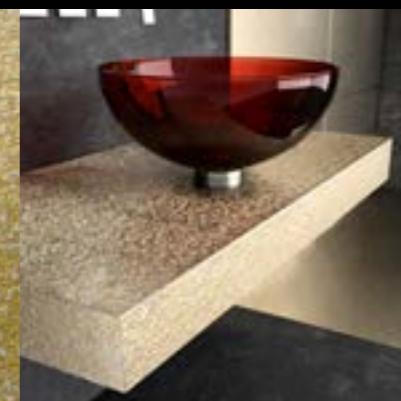

230

Specifiche
Data sheet

232

NATURA



Natura Wengé

236-241



Natura Rovere



242

Specifiche
Data sheet

244

Piatti doccia e
Top porta-lavabo
coordinati

TERRA



Terra Bianco 248-253

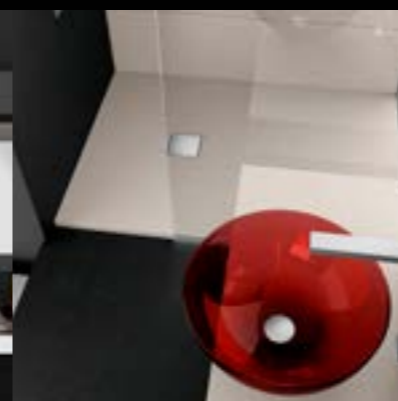

Terra Beige
254



Terra Tortora
256

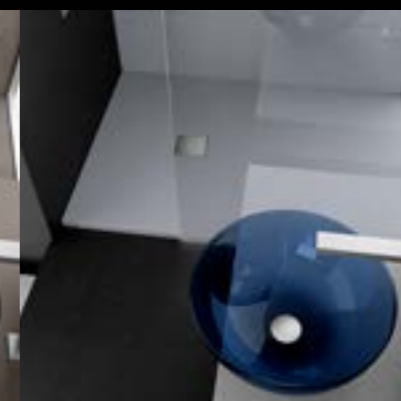

Terra Grigio
258

Specifiche
Data sheet

260-263

Shower trays matching
with tops for washbasin

FREESTANDING SOLUTIONS

I Freestanding della Glass Design nascono dalla passione e dall'impegno di dar vita a molto di più di un semplice lavabo ma ad una vera e propria scultura da terra. Un prodotto essenziale, impreziosito dalle più esclusive colorazioni e finiture che lo rendono il vero protagonista dell'ambiente.

Freestanding washbasins from Glass Design are borne from a passion and commitment to create more than just a simple washbasin but rather a real sculpture from the ground up. This essential product is embellished by exclusive colours and finishes making it a true protagonist of its environment.

Isola

made with
MURANO[®]
glass



Lavabo freestanding in vetro di Murano bianco opale satinato con Luci Led
Murano glass freestanding washbasin mat opal white with Led lighting set:
code **ISOLAS36L**



design by Alessandro Lenarda



Isola

made with
MURANO[®]
glass



Lavabo freestanding in vetro di Murano opale bianco con Luci Led *Murano glass freestanding washbasin opal white with Led lighting set: code ISOLAT36L*

design by Alessandro Lenarda



DA VINCI
TUSCANY 16

Freestanding

Solutions

17 DA VINCI
TUSCANY



Spazio

VetroFreddo®



Lavabo freestanding in **VetroFreddo®** bianco lucido Freestanding washbasin **VetroFreddo** white gloss: code **SPAZIOBL**



Lavabo freestanding in **VetroFreddo®** foglia oro Freestanding washbasin **VetroFreddo®** gold leaf
code **SPAZIOFO**

design by Thomas Bagnoli

Tempo

VetroFreddo®

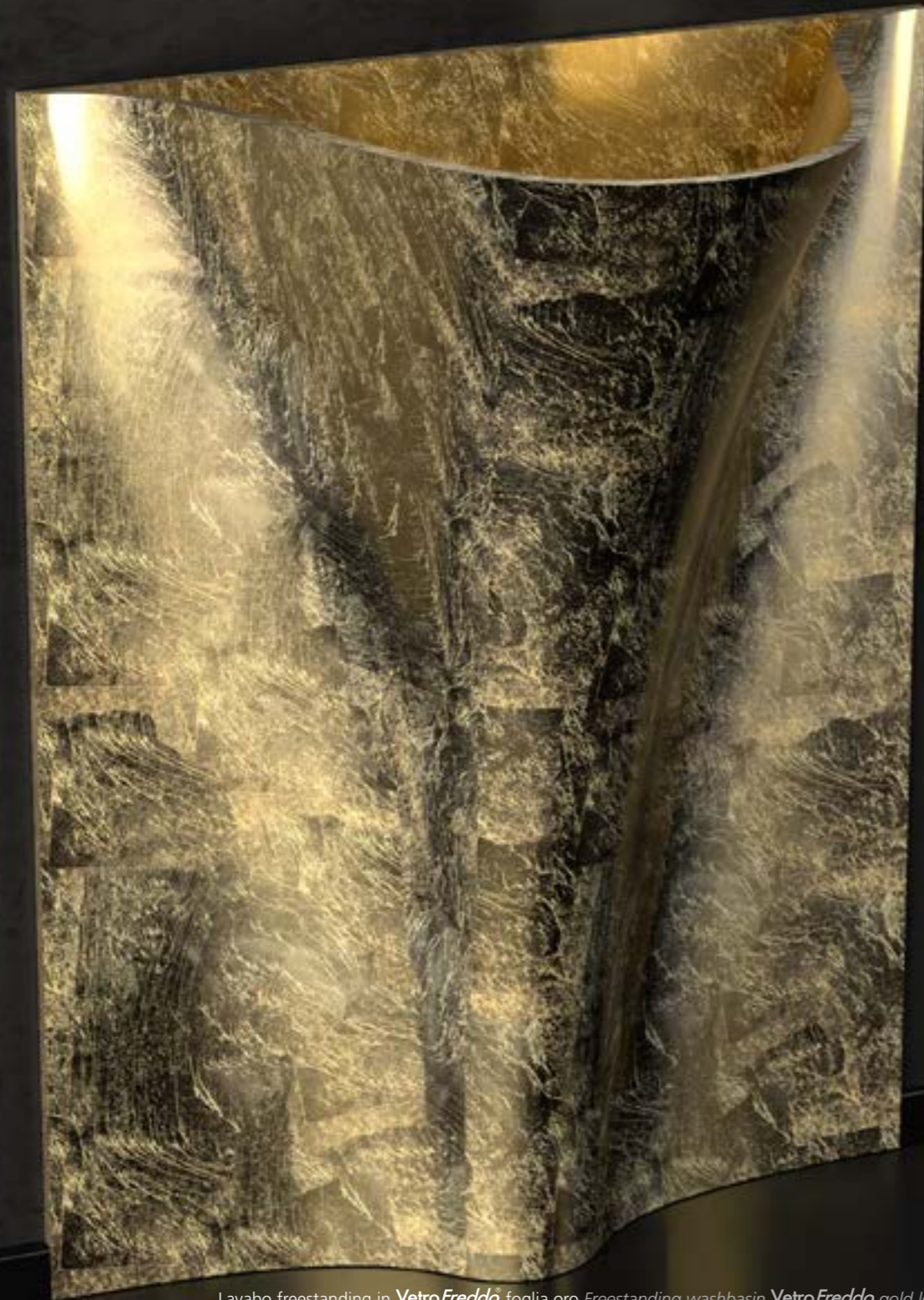

Lavabo freestanding in **VetroFreddo** foglia oro Freestanding washbasin **VetroFreddo** gold leaf: code **TEMPOFO**



Lavabo freestanding in **VetroFreddo** bianco opaco Freestanding washbasin **VetroFreddo** white mat code **TEMPOPO1**

design by Marco Pisati

FLOwer

Evolution

VetroFreddo®



Lavabo freestanding in **VetroFreddo®** foglia oro
Freestanding washbasin **VetroFreddo®** gold leaf: code **FLOEVOFO**
Specchio ovale foglia oro
Oval mirror gold leaf, size 95x65 cm: code **FLOMIROVFO**



Lavabo freestanding in **VetroFreddo®** nero Freestanding washbasin **VetroFreddo®** black mat: code **FLOEVOPO30**
Elemento in legno MDF con cassetto foglia oro. Apertura push&pull. Furniture element with drawer gold leaf in MDF wood. Push&pull opening:
code **SINCA100FO**
Specchio tondo nero opaco Round mirror black mat, size Ø70 cm:
code **FLOMIRRONO**

design by Marco Pisati

FLOwer

Evolution

VetroFreddo®



Lavabo freestanding in VetroFreddo® rosso Ferrari Freestanding washbasin VetroFreddo® Ferrari red: code FLOEVOPL34

design by Marco Pisati



FLOWer style

Bi-mat



Lavabo freestanding in **VetroFreddo** nero opaco Freestanding washbasin **VetroFreddo** black mat: code **FLOEVOPO30**

Vasca da bagno in "Bi-mat" nero opaco con interno bianco lucido Bathtub "Bi-mat" black mat finish, white gloss inside: code **FLOSTYBLW**

design by Marco Pisati

FLOWer style

Bi-mat



Vasca da bagno in "Bi-mat" finitura oro mat con interno bianco lucido
Bathtub "Bi-mat" Gold mat finish, white gloss inside
code **FLOSTYGDW**

design by Marco Pisati

Roma
ALTO

TeknoForm®



Lavabo freestanding in TeknoForm® foglia oro Freestanding washbasin TeknoForm® gold leaf: code **ROMAALFO**
Specchio ovale foglia oro Oval mirror gold leaf, size 95x65 cm: code **FLOMIROVFO**



Vasca da bagno in "Bi-mat" foglia oro con interno bianco lucido Bathtub "Bi-mat" gold leaf finish, white gloss inside: code **ROMASTYFOW**

design by Cairoli - Donzelli



DA VINCI 30
TUSCANY

Freestanding

Solutions

31 DA VINCI
TUSCANY



Roma
ALTO

TeknoForm®

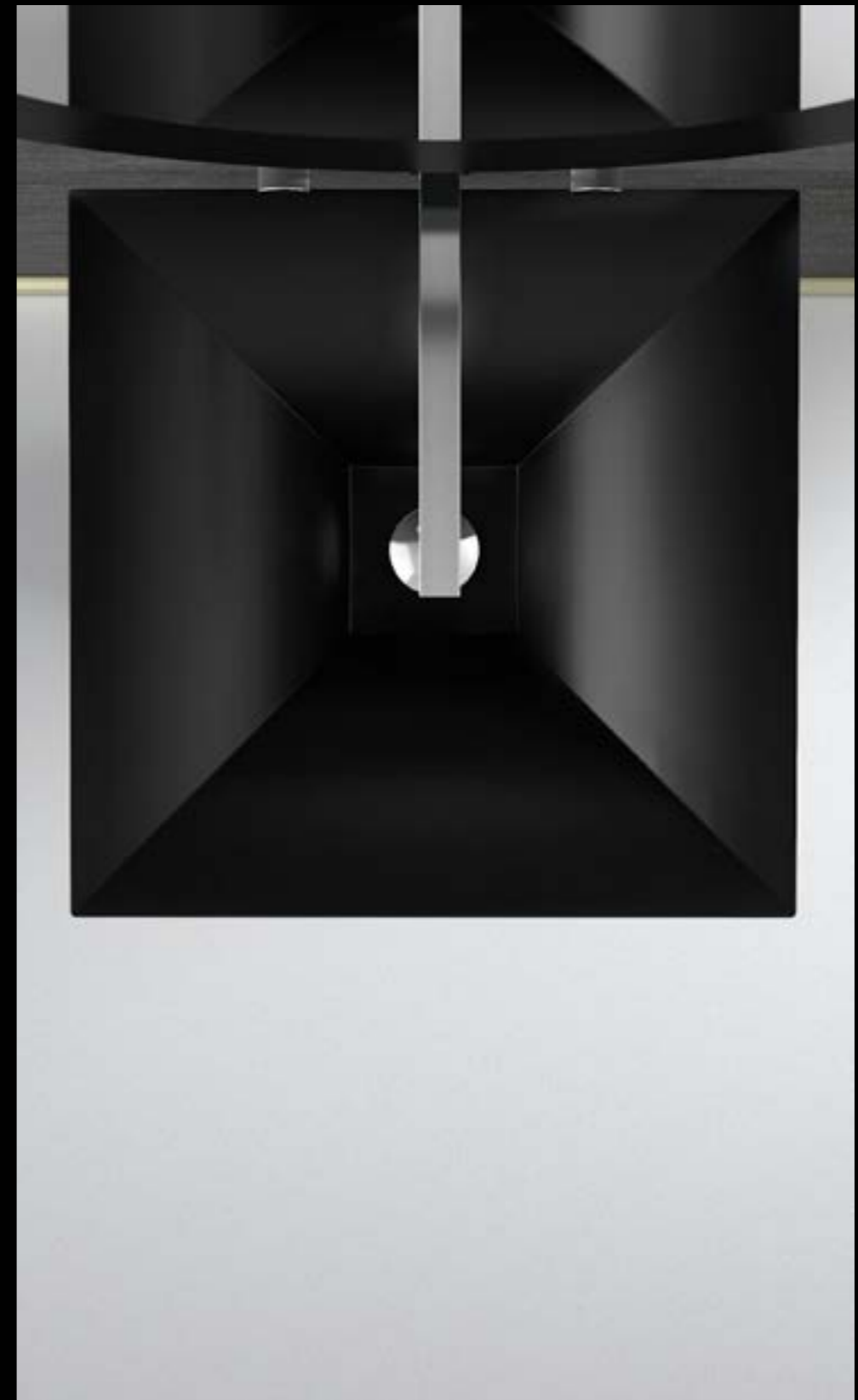

Lavabo freestanding in **TeknoForm®** nero opaco con bordo bianco
Freestanding washbasin TeknoForm® black mat with white border
code **ROMAALBWB**

Specchio ovale nero opaco
Oval mirror black mat, size 95x65cm
code **FLOMIROVNO**

design by Cairoli - Donzelli



DA VINCI
TUSCANY 32

Freestanding

Solutions

33 DA VINCI
TUSCANY



Roma
ALTO

TeknoForm®



Lavabo freestanding in TeknoForm® finitura dark inox mat, con interno bianco lucido
Freestanding washbasin TeknoForm® dark inox mat finish, white gloss basin:
code **ROMALDIW**

Roma
STYLE

Bi-mat



Vasca da bagno in "Bi-mat" finitura dark inox mat con interno bianco lucido
Bathtub "Bi-mat" dark inox mat finish, white gloss inside
code **ROMASTYDIW**

design by Cairoli - Donzelli



Tom Tom

Alumix®



Lavabo freestanding in Alumix bianco/ argento *Freestanding washbasin Alumix white/silver:*
code **ALUTOMTOMA05**

Lavabo freestanding in Alumix® nero / argento *Freestanding washbasin Alumix® black/silver:* code **ALUTOMTOMA02**
Specchio tondo in Alumix® nero / argento *Round mirror Alumix® black/silver, size Ø 66 cm:* code **ALUBJMIRA02**



DA VINCI 36
TUSCANY

Freestanding

Solutions

37 DA VINCI
TUSCANY



Tom Tom 2

VetroFreddo®



Lavabo freestanding in **VetroFreddo®** bianco lucido *Freestanding washbasin VetroFreddo® white gloss*: code **TOMTOM2BL**
Specchio tondo bianco lucido *Round mirror white gloss size Ø70 cm*: code **FLOMIRROBL**



Lavabo freestanding in **VetroFreddo®** nero lucido *Freestanding washbasin VetroFreddo® black gloss*: code **TOMTOM2NL**



Tommy

Vetro Freddo®



Lavabo freestanding in **Vetro Freddo®** bianco *Freestanding washbasin Vetro Freddo® white mat: code TOMMYP001*
Specchio tondo bianco opaco *Round mirror white mat size Ø70 cm: code FLOMIRROBO*

Tommy
METROPOLE

VetroFreddo®



Lavabo freestanding in **VetroFreddo** antracite con interno vasca nero opaco
Freestanding washbasin **VetroFreddo** anthracite finish, black mat basin: code **TOMMYMATPO30**



Lavabo freestanding in **VetroFreddo** finitura gold con interno vasca bianco lucido
Freestanding washbasin **VetroFreddo** gold finish, white gloss basin: code **TOMMYMGDW**



DA VINCI
TUSCANY 42

Freestanding

Solutions

43 DA VINCI
TUSCANY



Mini
BATHTUB

Bi-mat



Lavabo freestanding in **VetroFreddo** rosso Ferrari Freestanding washbasin **VetroFreddo** Ferrari red: code **TOMMYPL34**
Vasca da bagno in "Bi-mat" rosso Ferrari con interno bianco lucido Bath tub "Bi-mat" Ferrari red finish, white gloss inside: code **MINIRDW**

design by Marco Pisati



Mini BATHTUB

Bi-mat



Vasca da bagno in "Bi-mat" finitura dark inox mat con interno bianco lucido Bath tub "Bi-mat" dark inox mat finish, white gloss inside: code **MINIDIW**
Lavabo freestanding in **VetroFreddo** finitura dark inox mat con interno vasca bianco opaco Freestanding washbasin **VetroFreddo** dark inox mat finish, white mat basin code **TOMMYDIPO01**

design by Marco Pisati

Mont Blanc

BATHTUB

Bi-mat



Vasca da bagno in "Bi-mat" finitura nero lucido con interno bianco lucido Bathtub "Bi-mat" black gloss finish, white gloss inside: code **MONTBLANCLGW**
Lavabo in *Pert* bianco opaco con cover Washbasin *Pert* white mat with cover: code **BLADEBO**

Mont Blanc

BATHTUB

Bi-mat



Vasca da bagno in "Bi-mat" foglia argento con interno bianco lucido
Bathtub "Bi-mat" silver leaf, white gloss inside
code **MONTBLANCFAW**

Paradiso

BATHTUB

Bi-mat



Lavabo in **Vetro Freddo**® finitura gold mat con interno bianco opaco Washbasin **Vetro Freddo**® gold mat finish, white mat inside: code **KOOLOVERGDP001**
Vasca da bagno in "Bi-mat" finitura gold mat con interno bianco lucido Bath tub "Bi-mat" gold mat finish, white gloss inside: code **PARADISOGDW**

Paradiso

BATHTUB

Bi-mat



Lavabo in **VetroFreddo**® nero opaco Washbasin **VetroFreddo**® black mat: code **KOOLOVERPO30**
Vasca da bagno in "Bi-mat" finitura nero opaco con interno bianco lucido Bathtub "Bi-mat" black mat finish, white gloss inside: code **PARADISOBLW**

“specifiche”
data sheet



ISOLA

made with
MURANO®
glass

design by:
ALESSANDRO LENARDA

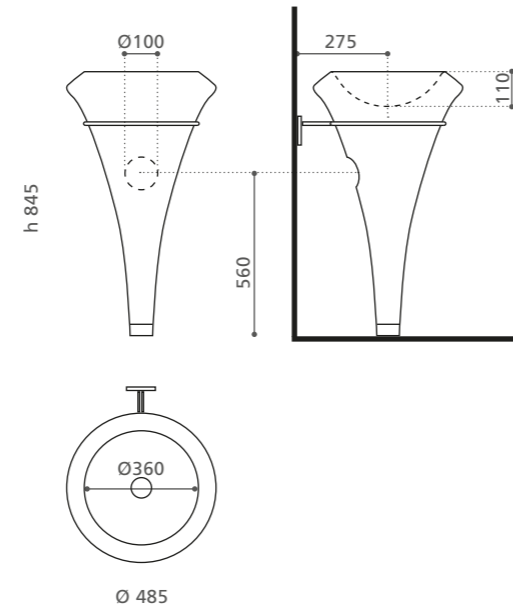

Ø foro / hole = 45 mm
peso / weight = 10,00 kg



opal white
ISOLAT36L



opal white mat
ISOLAS36L

Completo di anello cromato con piastra per fissaggio a parete e base a terra. Illuminazione led e trasformatore inclusi.
Equipped with chrome ring for wall fixation and base. Led lighting set and transformer included.



SPAZIO

Vetro Freddo®

design by:
THOMAS BAGNOLI

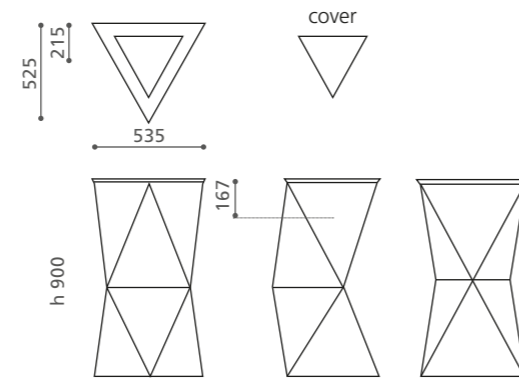

Ø foro / hole = 45 mm
peso / weight = 22,5 kg



white gloss
SPAZIOBL



white mat
SPAZIOPO01



black gloss
SPAZIONL



black mat
SPAZIOPO30



Ferrari red
SPAZIOPL34



gold leaf
SPAZIOFO



silver leaf
SPAZIOFA



gold mat / white
SPAZIOGDPO01



dark inox mat / white
SPAZIODIPO01

Completo di scarico a terra. Complete floor waste connection included.



TEMPO

Vetro Freddo®

design by:
MARCO PISATI

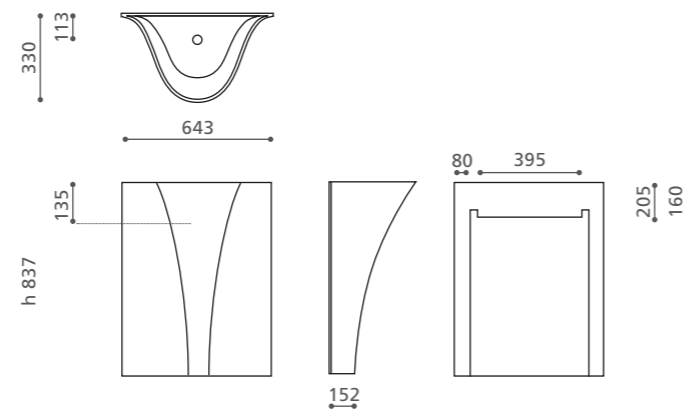

Ø foro / hole = 45 mm
peso / weight = 21 kg



white mat
TEMPOPO01



black mat
TEMPOPO30



Ferrari red
TEMPOPL34



silver leaf
TEMPOFO



gold leaf
TEMPOFA



gold mat / white
TEMPOGDPO01



dark inox mat / white
TEMPODIP001

Corredato di piastra di ancoraggio a parete. Equipped with wall fixing plate.



FLOWER Evolution

VetroFreddo®

design by:
MARCO PISATI

brevettato / patented

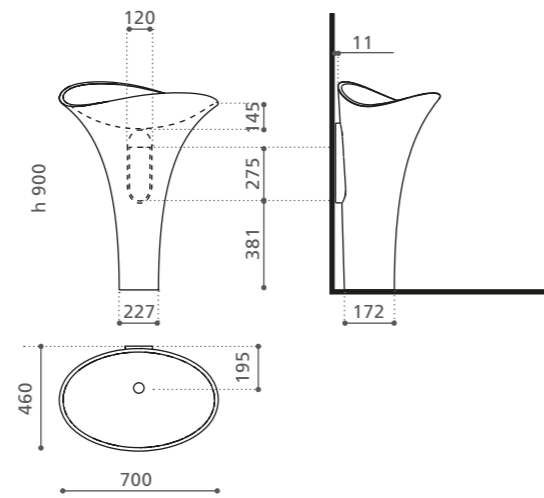

Ø foro / hole = 45 mm
peso / weight = 22,00 kg

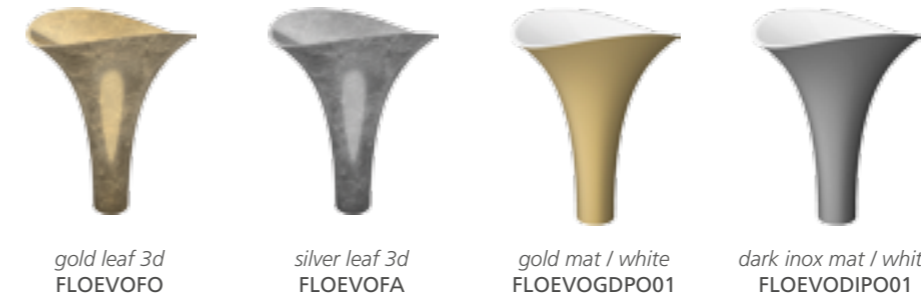

Corredato di piastra di ancoraggio a parete. Equipped with wall fixing plate.



ROMA Alto

TeknoForm®

design by:
CAIROLI-DONZELLI

brevettato / patented

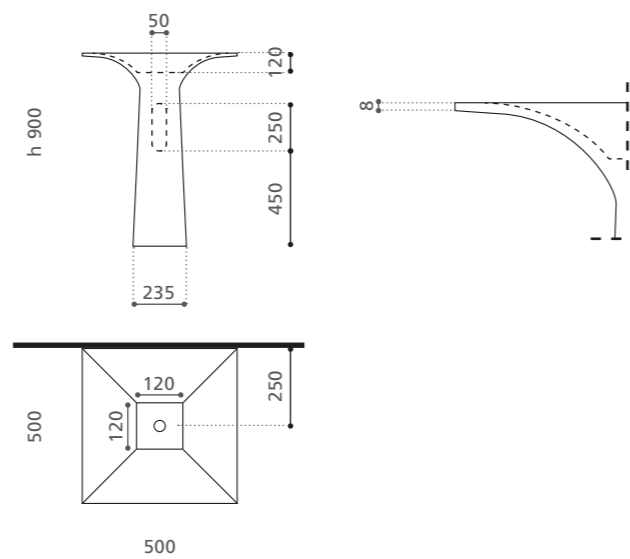

Ø foro / hole = 45 mm
peso / weight = 21,00 kg



TOM TOM

Alumix®

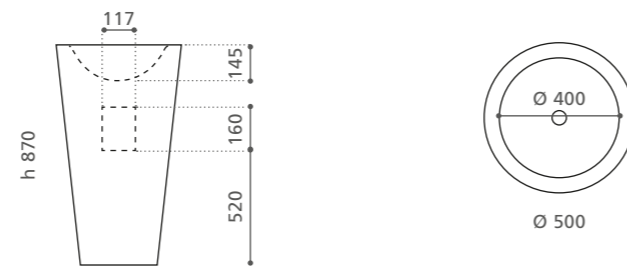

Ø foro / hole = 45 mm
peso / weight = 8,40 kg



TOM TOM 2

VetroFreddo®

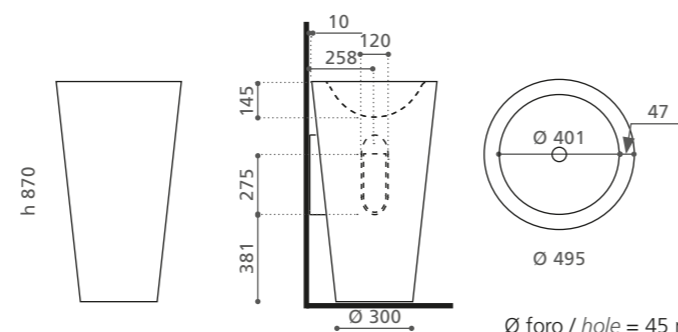

Ø foro / hole = 45 mm
peso / weight = 23,00 kg



Corredato di piastra di ancoraggio a parete. Equipped with wall fixing plate.



TOMMY

Vetro Freddo®

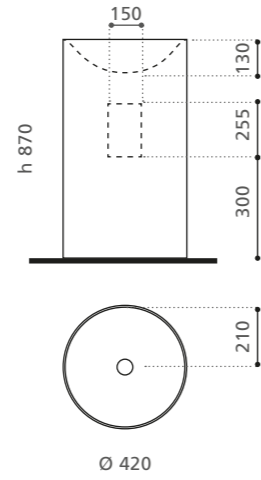

Ø foro / hole = 45 mm
peso / weight = 26,30 kg



TOMMY

metropole

Vetro Freddo®

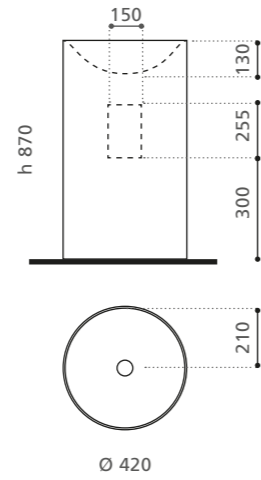

Ø foro / hole = 45 mm
peso / weight = 26,30 kg



RACCORDO free standing

per FLOWER Evolution, TOM TOM 2, TEMPO

Freestanding waste joint for Flower Evolution, TomTom2, TEMPO

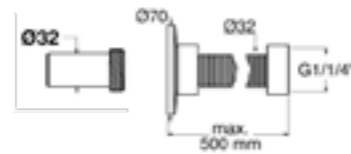

chrome/ABS
SCCR-RACC.DM32L500

Tubo corrugato d.32 mm per raccordo a piletta (l.500mm, uscita attacco 32mm)
Flexible pipe d.32 mm for waste joint on freestanding washbasin

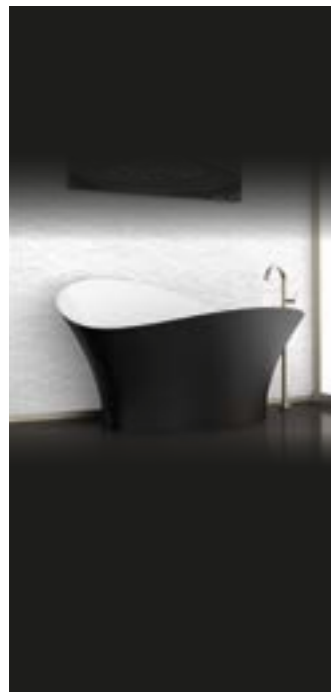

FLOWER style

Bi-mat

design by:
MARCO PISATI

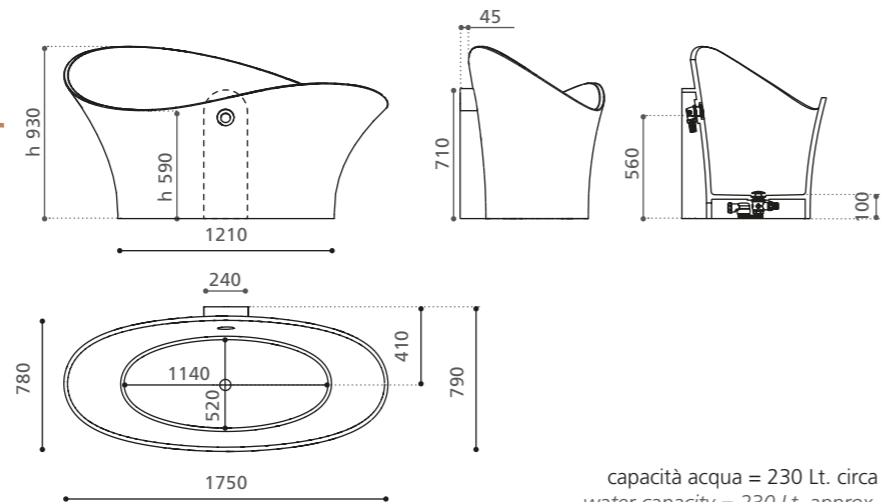

capacità acqua = 230 Lt. circa
water capacity = 230 Lt. approx.
peso / weight = 44,00 kg

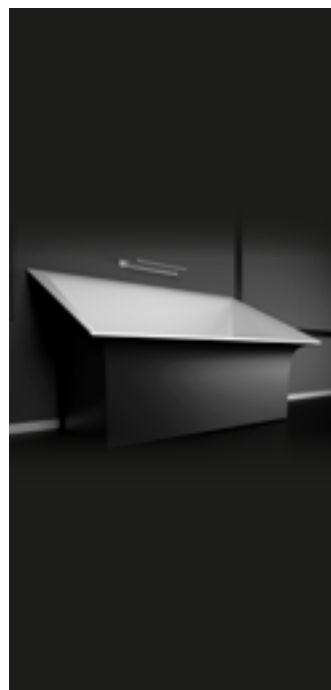

ROMA style

Bi-mat

design by:
CAIROLI-DONZELLI

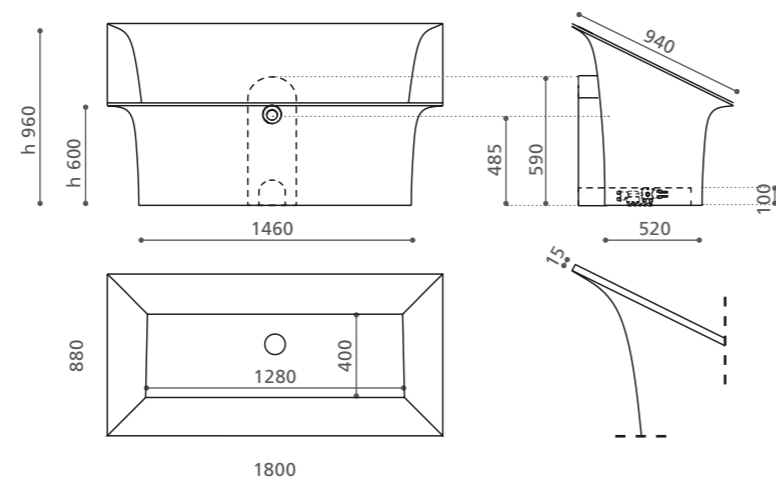

capacità acqua = 180 Lt. circa
water capacity = 180 Lt. approx.
peso / weight = 58,00 kg



MINI bathtub

Bi-mat

design by:
MARCO PISATI

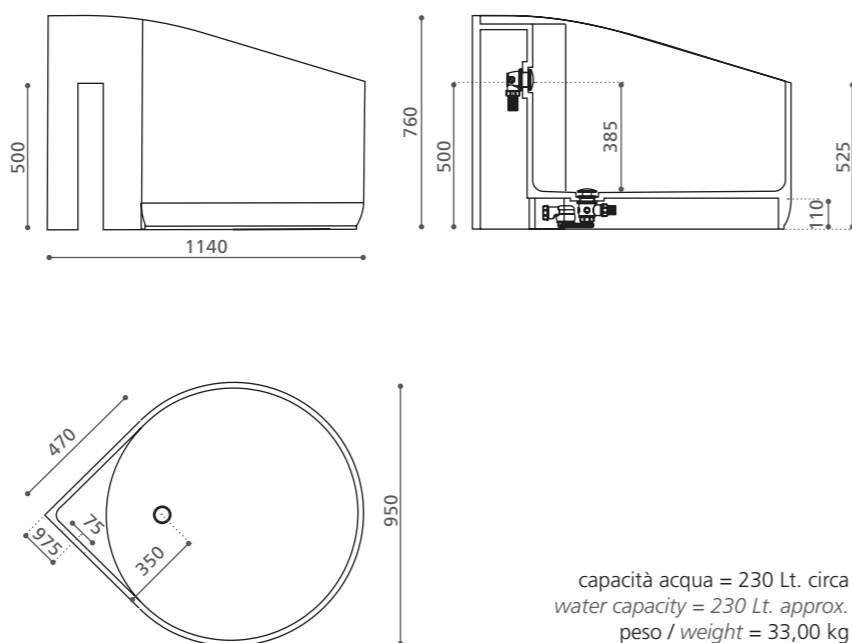

capacità acqua = 230 Lt. circa
water capacity = 230 Lt. approx.
peso / weight = 33,00 kg





MONTBLANC bathtub

Bi-mat

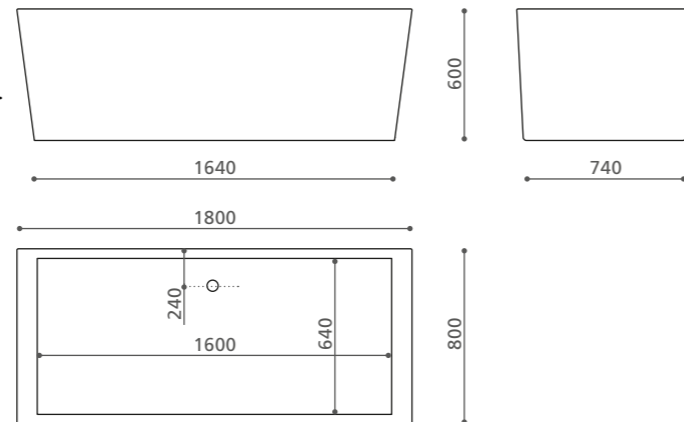

capacità acqua = 280 Lt. circa
water capacity = 280 Lt. approx.
peso / weight = 50 kg



PARADISO bathtub

Bi-mat

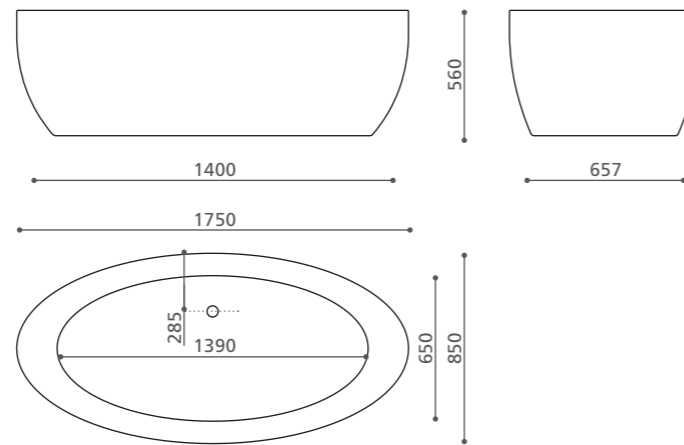

capacità acqua = 190 Lt. circa
water capacity = 190 Lt. approx.
peso / weight = 39,50 kg



Scarico per vasca Bathtub waste with overflow

Scarico con troppo pieno per vasca e piletta Up & Down
Polypropylene pop up bathtub waste. Up & down mechanism

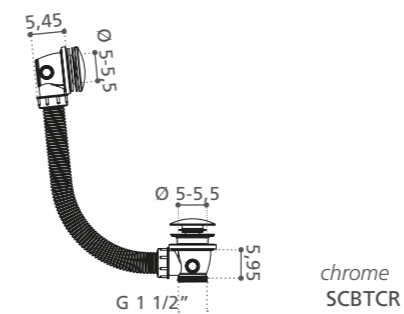





IN-OUT SOLUTIONS

La scoperta dell'eleganza nascosta. *The discovery of hidden elegance.*

Il programma IN-OUT rappresenta collezioni di lavabi integrati, giocando con soluzioni cromatiche, stilistiche e dinamiche, che diventano espressione di sensazioni, colori ed emozioni. *The In-Out series is represented by a full range of integrated washbasins, playing with stylish and chromatic solutions, expressing feelings, colours and emotions.*



Kool
XL FL

Vetro Freddo®



Lavabo in **Vetro Freddo®**, foglia oro / washbasin **Vetro Freddo®** gold leaf: code **KOOLXLFLFO**
Top in legno MDF bianco lucido / top white gloss in MDF wood: code **SIN100L0101**
Elemento in legno MDF con cassetto bianco lucido. Apertura push & pull / Furniture element with drawer white gloss in MDF wood. Push & pull opening:
code **SINCA100L01**



Lavabo in **Vetro Freddo®** nero opaco / washbasin **Vetro Freddo®** black mat: code **KOOLXLFLPO30**
Top in legno MDF nero lucido / top black gloss in MDF wood: code **SIN100L3001**
Elemento in legno MDF con cassetto nero lucido. Apertura push & pull / furniture element with drawer black gloss in MDF wood.
Push & pull opening: code **SINCA100L30**



Circus
43 FL

TeknoForm®



Lavabo in TeknoForm® bianco opaco / washbasin TeknoForm® white mat: code **CIRCUS43FLPO01**
Top in legno MDF nero lucido/top black gloss in MDF wood: code **SIN80L3002**
Elemento in legno MDF con cassetto nero lucido. Apertura push & pull/furniture element with drawer black gloss in MDF wood. Push & pull opening: code **SINCA120L30**

Circus
50 FL

TeknoForm®



Lavabo in TeknoForm® foglia argento / washbasin TeknoForm® silver leaf: code **CIRCUS50FLFA**
Top in legno MDF nero lucido / top black gloss in MDF wood: code **SIN100L3003**
Elemento in legno MDF con cassetto nero lucido. Apertura push & pull / furniture element with drawer black gloss in MDF wood. Push & pull opening: code **SINCA80L30**



Lavabo in TeknoForm® bianco opaco / washbasin TeknoForm® white mat: code **CIRCUS50FLPO01**
Top in legno MDF nero lucido / top black gloss in MDF wood: code **SIN100L3003**
Elemento in legno MDF con cassetto nero lucido. Apertura push & pull / furniture element with drawer black gloss in MDF wood. Push & pull opening: code **SINCA80L30**

Open

Pert®

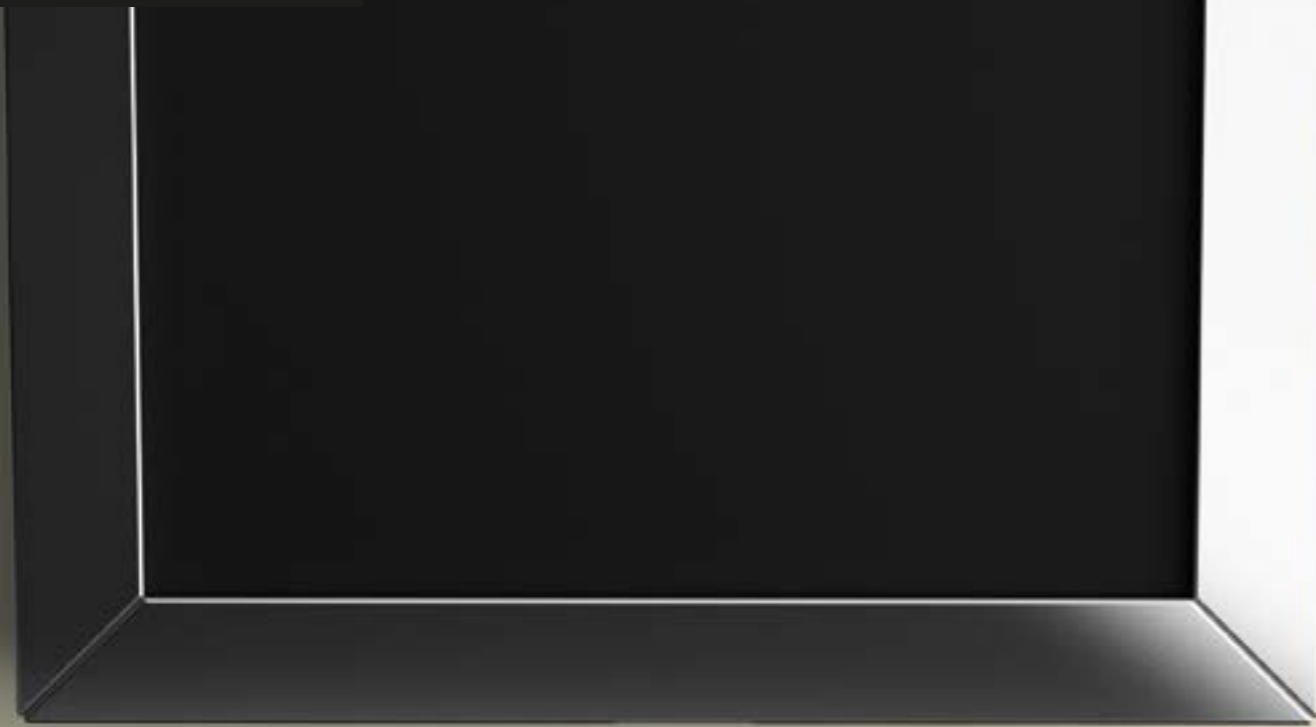

Lavabo in *Pert*® nero lucido / washbasin *Pert*® black gloss: code **OPEN402**
Top in legno MDF nero lucido / top black gloss in MDF wood: code **SIN120L3004**



Lavabo in *Pert*® foglia oro / washbasin *Pert*® gold leaf: code **OPENFO**
Top in legno MDF bianco lucido / top white gloss in MDF wood: code **SIN120L0104**
Elemento in legno MDF con cassetto foglia oro. Apertura push & pull / furniture element with drawer gold leaf in MDF wood.
Push & pull opening: code **SINCA120FO**

Italy
FL

VetroFreddo®



Lavabo in **VetroFreddo®** nero opaco / washbasin **VetroFreddo®** black mat: code **ITALYFLPO303F**
Top in legno MDF bianco lucido / top white gloss in MDF wood: code **SIN120L0105**
Elemento in legno MDF con cassetto bianco lucido. Apertura push & pull / furniture element with drawer white gloss in MDF wood. Push & pull opening: code **SINCA100L01**



Lavabo in **VetroFreddo®** bianco opaco / washbasin **VetroFreddo®** white mat: code **ITALYFLPO013F**
Top in legno MDF nero lucido / top black gloss in MDF wood: code **SIN120L3005**
Elemento in legno MDF con cassetto nero lucido. Apertura push & pull / furniture element with drawer black gloss in MDF wood. Push & pull opening: code **SINCA100L30**

Riv
FL

VetroFreddo®



Lavabo in **VetroFreddo** nero opaco / washbasin **VetroFreddo** black mat: code **RIVFLPO303F**

Top in legno MDF bianco lucido / top white gloss in MDF wood: code **SIN100L0106**

Elemento in legno MDF con cassetto bianco lucido. Apertura push & pull / furniture element with drawer white gloss in MDF wood. Push & pull opening: code **SINCA80L01**



DA VINCI 80
TUSCANY

IN-OUT

Solutions

81 DA VINCI
TUSCANY



Kosta I

VetroFreddo®



Lavabo in **VetroFreddo** foglia oro / washbasin **VetroFreddo** gold leaf: code **KOSTA1FO**
Top in legno MDF bianco lucido / top white gloss in MDF wood: code **SIN100L0107**
Elemento in legno MDF con cassetto foglia oro. Apertura push & pull / furniture element with drawer gold leaf in MDF wood. Push & pull opening: code **SINCA100FO**



Lavabo in **VetroFreddo** bianco opaco / washbasin **VetroFreddo** white mat: code **KOSTA1PO01**
Top in legno MDF nero lucido / top black gloss in MDF wood: code **SIN100L3007**
Elemento in legno MDF con cassetto bianco lucido. Apertura push & pull / furniture element with drawer white gloss in MDF wood. Push & pull opening: code **SINCA100L01**

Kosta II

VetroFreddo®



Lavabo in **VetroFreddo** foglia oro / washbasin **VetroFreddo** gold leaf: code **KOSTA2FO**
Top in legno MDF bianco lucido / top white gloss in MDF wood: code **SIN120L0108**
Elemento in legno MDF con cassetto bianco lucido. Apertura push & pull / furniture element with drawer white gloss in MDF wood.
Push & pull opening: code **SINCA80L01**



Lavabo in **VetroFreddo** nero opaco / washbasin **VetroFreddo** black mat: code **KOSTA2PO30**
Top in legno MDF bianco lucido / top white gloss in MDF wood: code **SIN100L0108**

Rx

VetroFreddo®



Lavabo in **VetroFreddo®** bianco opaco / Washbasin **VetroFreddo®** white mat: code **RXP001**
Doppio Top in legno MDF nero lucido / Double top black gloss in MDF wood: code **SIN100L3009**
Elemento in legno MDF con cassetto nero lucido. Apertura push & pull / furniture element with drawer black gloss in MDF wood. Push & pull opening: code **SINCA80L30**

VOLcano
FL

VetroFreddo®



Lavabo in VetroFreddo® nero opaco / Washbasin VetroFreddo® black mat: code **VOLCANOFLPO30**
Doppio Top in legno MDF bianco lucido / Double top white gloss in MDF wood: code **SIN80L0110**
Elemento in legno MDF con cassetto bianco lucido. Apertura push & pull / furniture element with drawer white gloss in MDF wood. Push & pull opening:
code **SINCA80L01**



DA VINCI 88
TUSCANY

IN-OUT

Solutions

89 DA VINCI
TUSCANY



Play
FL

VetroFreddo®



Lavabo in **VetroFreddo** foglia argento / Washbasin **VetroFreddo** silver leaf: code **PLAYFLFA**
Doppio Top in legno MDF bianco lucido / Double top white gloss in MDF wood: code **SIN120L0111**
Doppio elemento in legno MDF con cassetto foglia argento. Apertura push & pull / Double furniture element with drawer silver leaf in MDF wood. Push & pull opening:
code **SINCA120FA**

Ellisse

FL

small - large - xl

VetroFreddo®



Lavabo in VetroFreddo® nero opaco / Washbasin VetroFreddo® black mat: code **ELLISSEXLFLPO30**
Top in legno MDF bianco lucido / top white gloss in MDF wood: code **SIN80L0115**
Elemento centrale in legno MDF con cassetto nero lucido. Apertura push & pull / central furniture element with drawer black gloss in MDF wood. Push & pull opening: code **SINCA80L30**
Specchio tondo nero lucido / Round mirror black gloss Ø70 cm: code **FLOMIRONL**
Accessori serie Kleiss VetroFreddo® nero / Accessories Kleiss set VetroFreddo® black: code **KLSETPO30**

Tondo
FL

VetroFreddo®



Lavabo in **VetroFreddo®** foglia oro / washbasin **VetroFreddo®** gold leaf: code **TONDOFLFO**
Top in legno MDF bianco lucido / top white gloss in MDF wood: code **SIN80L0116**
Elemento in legno MDF con cassetto bianco lucido. Apertura push & pull / furniture element with drawer white gloss in MDF wood. Push & pull opening: code **SINCA80L01**

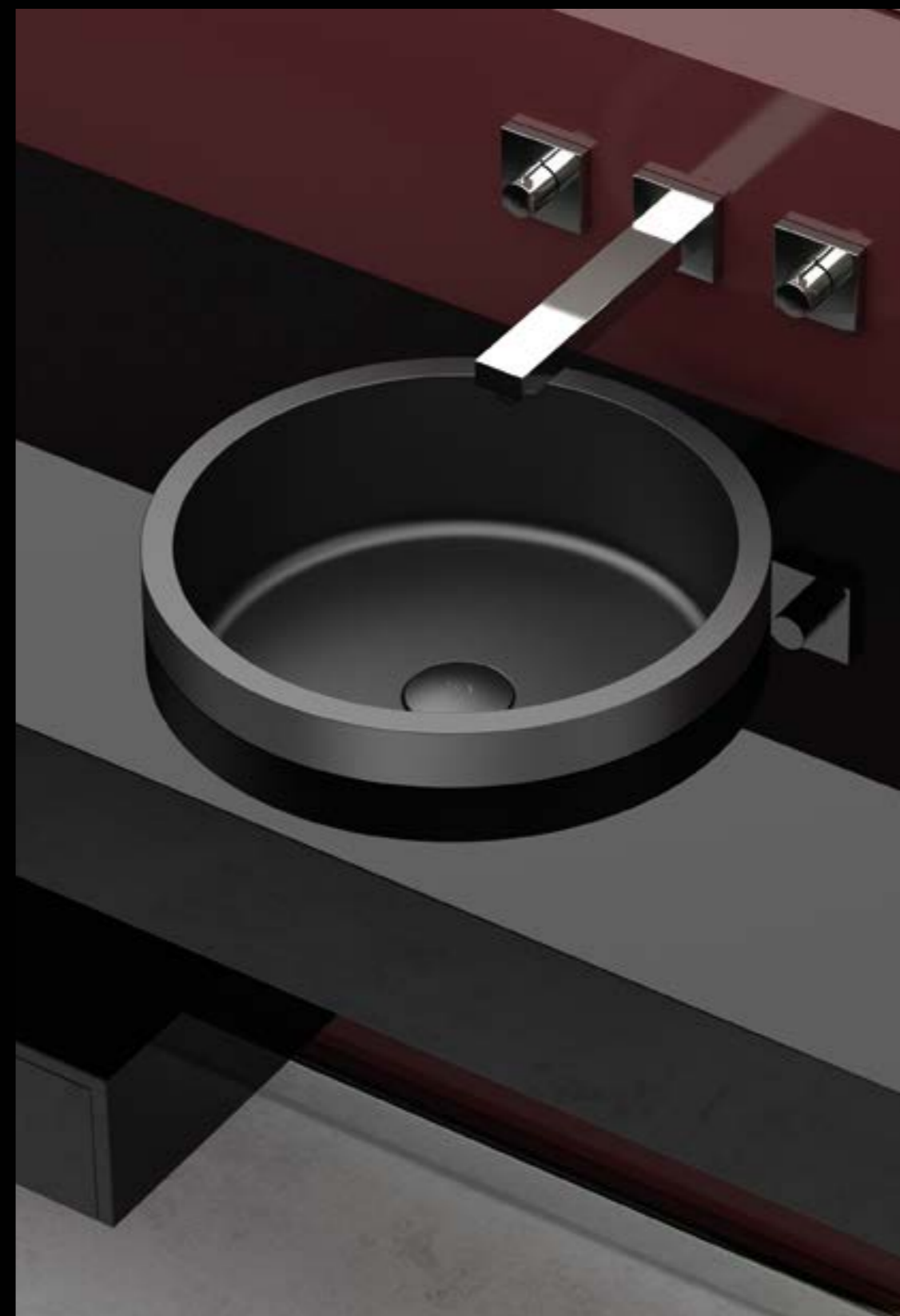

Lavabo in **VetroFreddo®** nero opaco / washbasin **VetroFreddo®** black mat: code **TONDOFLPO30**
Top in legno MDF nero lucido / top black gloss in MDF wood: code **SIN100L3016**
Elemento in legno MDF con cassetto nero lucido. Apertura push & pull / furniture element with drawer black gloss in MDF wood. Push & pull opening: code **SINCA80L30**

Naxos
FL

VetroFreddo®



Lavabo in **VetroFreddo®** bianco opaco / Washbasin **VetroFreddo®** white mat: code **NAXOSFLPO01**
Top in legno MDF nero lucido / top black gloss in MDF wood: code **SIN80L3017**
Elemento centrale in legno MDF con cassetto bianco lucido. Apertura push & pull / central furniture element with drawer white gloss in MDF wood.
Push & pull opening: code **SINCA100L01**

Play In

VetroFreddo®



Vasca integrata in VetroFreddo® bianco opaco / integrated washbasin VetroFreddo® white mat: code **PLI510C1020PO01**
Top in legno MDF nero lucido / top black gloss in MDF wood: code **SIN100L3012**
Elemento in legno MDF con cassetto nero lucido. Apertura push & pull / furniture element with drawer black gloss in MDF wood. Push & pull opening: code **SINCA80L30**



Vasca integrata in VetroFreddo® bianco opaco / integrated washbasin VetroFreddo® white mat: code **PLI510C1020PO01**
Top in legno MDF beige lucido / Top in gloss beige MDF wood: code **SIN100L2012**
Elemento in legno MDF con cassetto beige lucido. Apertura push & pull / furniture element with drawer in gloss beige MDF wood. Push & pull opening: code **SINCA80L20**
Colonna sospesa reversibile in legno MDF beige lucido / Suspended reversible tall cabinet in gloss beige MDF wood: Sintesi code **SINCOL20**

“specifiche”
data sheet



Kool XL FL

brevettato / patented

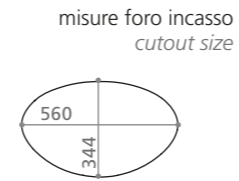
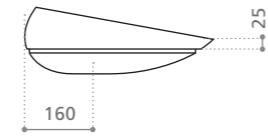
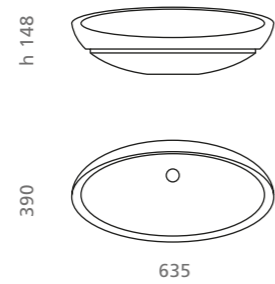

misure foro incasso
cutout size

Ø foro / hole = 45 mm
peso / weight = 6,50 kg

code:



white mat
KOOLXLFLPO01



black mat
KOOLXLFLPO30



gold leaf 3d
KOOLXLFLFO



silver leaf 3d
KOOLXLFLFA

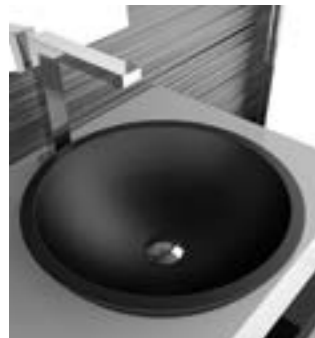

Circus 43 FL

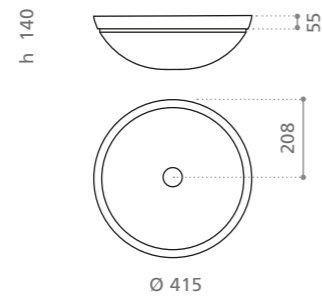

misure foro incasso
cutout size

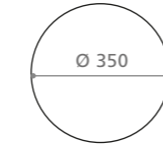

Ø foro / hole = 45 mm
peso / weight = 6,80 kg

code:



white mat
CIRCUS43FLPO01



black mat
CIRCUS43FLPO30



gold leaf 3d
CIRCUS43FLFO



silver leaf 3d
CIRCUS43FLFA



Circus 50 FL

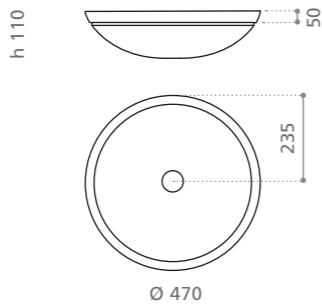

misure foro incasso
cutout size

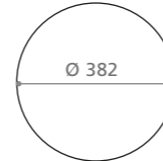

Ø foro / hole = 45 mm
peso / weight = 8,80 kg

code:



white mat
CIRCUS50FLPO01



black mat
CIRCUS50FLPO30



gold leaf 3d
CIRCUS50FLFO



silver leaf 3d
CIRCUS50FLFA



Open

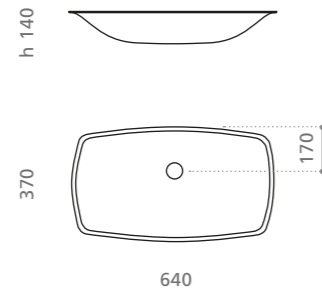

misure foro incasso
cutout size

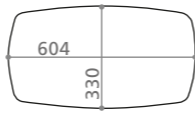

Ø foro / hole = 45 mm
peso / weight = 3,50 kg

code:



white gloss
OPEN401



black gloss
OPEN402



gold leaf 3d
OPENFO



silver leaf 3d
OPENFA



Italy FL

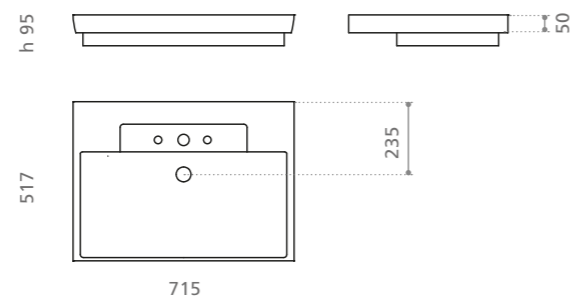

misure foro incasso
cutout size



Ø foro / hole = 45 mm
peso / weight = 18,00 kg

code:



white mat - 1 hole
ITFLPO01M



black mat - 1 hole
ITFLPO30M



white mat - 3 holes
ITFLPO013F



black mat - 3 holes
ITFLPO303F

1 foro per rubinetto/1 hole for tap

3 fori per rubinetto/3 holes for tap

I colori rappresentati in stampa si intendono puramente indicativi. - Print colours of the washbasins may vary slightly from original colour.



Riv FL

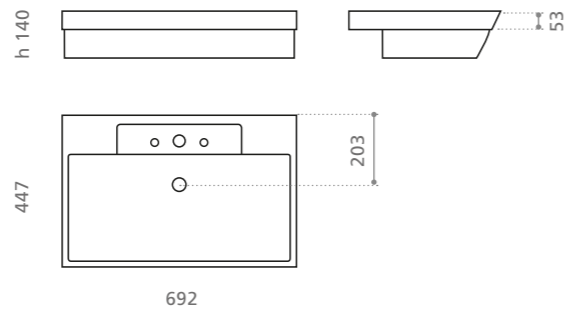

misure foro incasso
cutout size

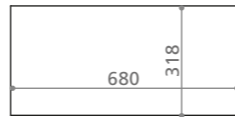

Ø foro / hole = 45 mm
peso / weight = 17,20 kg



code:

white mat - 1 hole
RVFLPO01M

black mat - 1 hole
RVFLPO30M

white mat - 3 holes
RVFLPO13F

black mat - 3 holes
RVFLPO30F

1 foro per rubinetto/1 hole for tap

3 fori per rubinetto/3 holes for tap



Kosta I

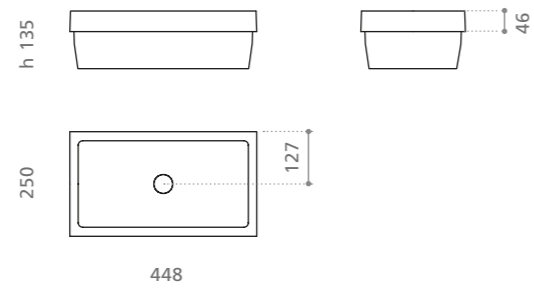

misure foro incasso
cutout size



Ø foro / hole = 45 mm
peso / weight = 7,20 kg



code:

white mat
KOSTA1PO01

black mat
KOSTA1PO30

gold leaf 3d
KOSTA1FO

silver leaf 3d
KOSTA1FA



Kosta II

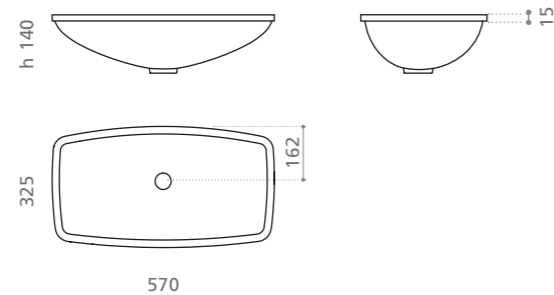

misure foro incasso
cutout size

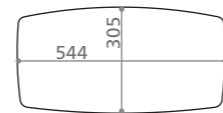

Ø foro / hole = 45 mm
peso / weight = 6,50 kg



code:

white mat
KOSTA2PO01

black mat
KOSTA2PO30

gold leaf 3d
KOSTA2FO

silver leaf 3d
KOSTA2FA



Rx

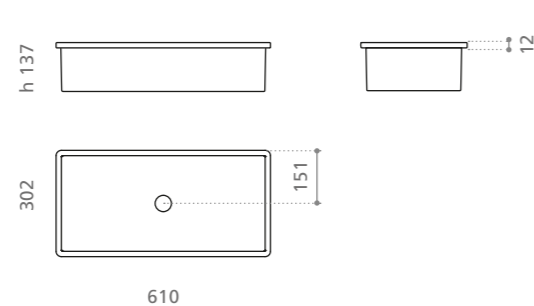

misure foro incasso
cutout size

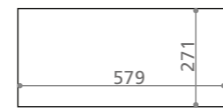

Ø foro / hole = 45 mm
peso / weight = 7,70 kg



code:

white mat
RXPO01

black mat
RXPO30

gold leaf 3d
RXFO

silver leaf 3d
RXFA



VOLcano
FL

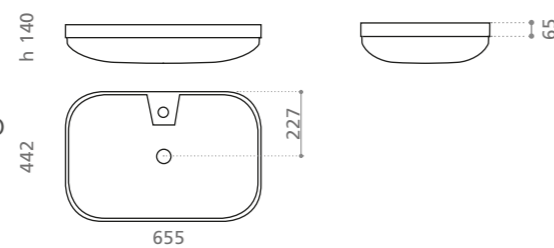

misure foro incasso
cutout size

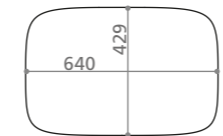

Ø foro / hole = 45 mm
peso / weight = 11,00 kg



code:

white mat
VOLCANOFLPO01

black mat
VOLCANOFLPO30



Play FL

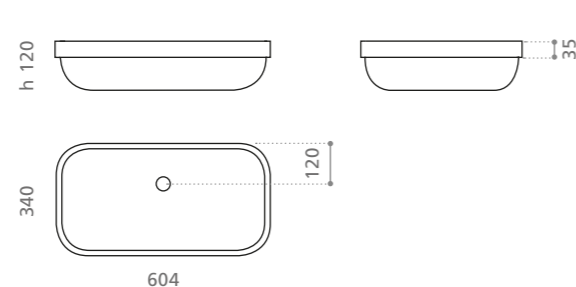

misure foro incasso
cutout size

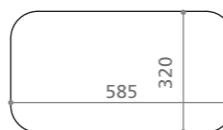

Ø foro / hole = 45 mm



code:

white mat
PLAYFLPO01

black mat
PLAYFLPO30

gold leaf 3d
PLAYFLFO

silver leaf 3d
PLAYFLFA

I colori rappresentati in stampa si intendono puramente indicativi. - Print colours of the washbasins may vary slightly from original colour.



Ellisse FL
small

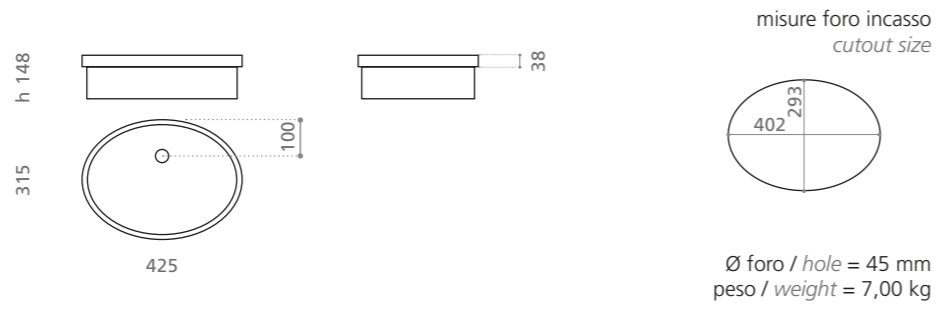

code:



Tondo FL

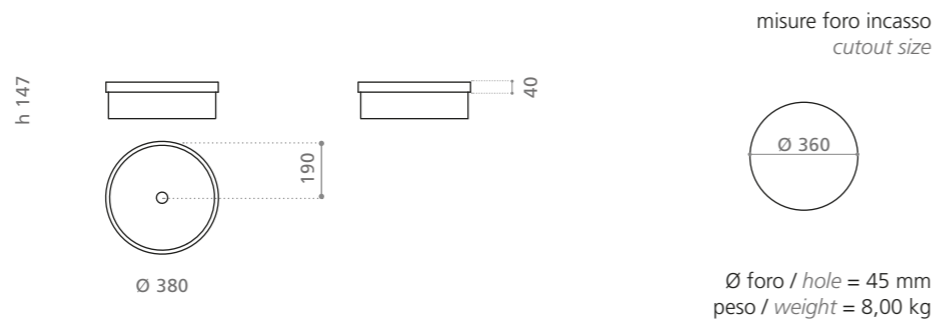

code:



Naxos FL

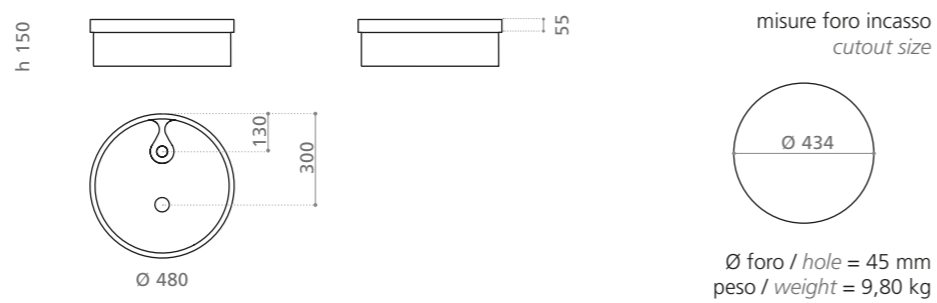

code:

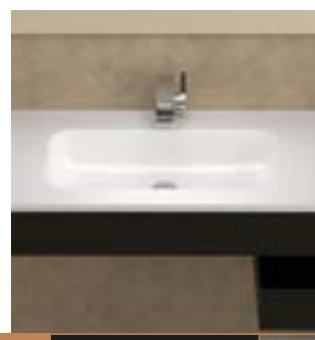

Play In

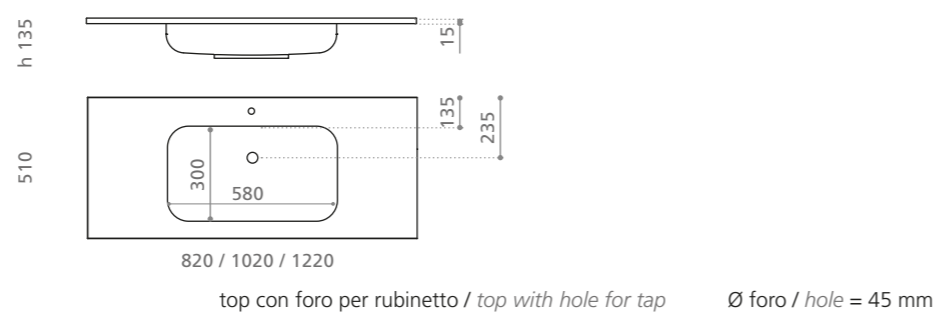

code:



code:



I colori rappresentati in stampa si intendono puramente indicativi. - Print colours of the washbasins may vary slightly from original colour.

Sintesi

Top porta-lavabo *Top for washbasin*



I top Glass Design sono stati studiati per attribuire semplice eleganza e una perfetta coordinabilità con tutta la gamma di lavabi, delle cassettiere e dei pensili.
Glass Design tops provide a simple elegance and are a perfect fit with the entire washbasin range, drawers and suspended tall cabinets.

I top realizzati in legno MDF vengono forniti con foro centrale per il corretto alloggiamento del lavabo scelto garantendo precisione e velocità di installazione.
Tops are supplied in MDF wood with a central cutout for the selected washbasin, allowing for easy installation.

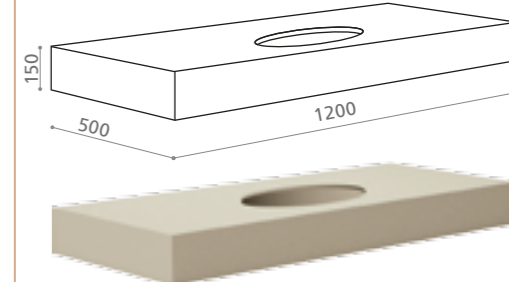
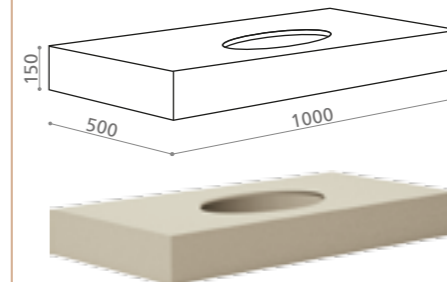
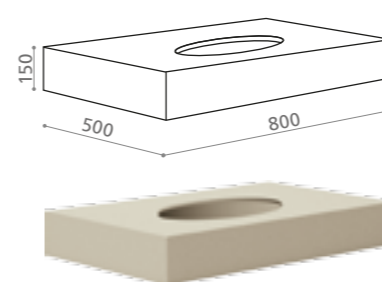

gloss beige code:

SIN80L2001	(for KOOL XL FL)*
SIN80L2002	(for CIRCUS43 FL)*
SIN80L2003	(for CIRCUS50 FL)
SIN80L2004	(for OPEN)*
SIN80L2005	(for ITALY FL)
SIN80L2006	(for RIV FL)
SIN80L2007	(for KOSTA I)*
SIN80L2008	(for KOSTA II)*
SIN80L2009	(for RX)*
SIN80L2010	(for VOLCANO FL)
SIN80L2011	(for JIMMY FL)*
SIN80L2012	(for JIMMY IN)
SIN80L2013	(for ELLISSE FL small)*
SIN80L2014	(for ELLISSE FL large)*
SIN80L2015	(for ELLISSE FL xl)*
SIN80L2016	(for TONDO FL)*
SIN80L2017	(for NAXOS FL)

SIN100L2001	(for KOOL XL FL)*
SIN100L2002	(for CIRCUS43 FL)*
SIN100L2003	(for CIRCUS50 FL)
SIN100L2004	(for OPEN)*
SIN100L2005	(for ITALY FL)
SIN100L2006	(for RIV FL)
SIN100L2007	(for KOSTA I)*
SIN100L2008	(for KOSTA II)*
SIN100L2009	(for RX)*
SIN100L2010	(for VOLCANO FL)
SIN100L2011	(for JIMMY FL)*
SIN100L2012	(for JIMMY IN)
SIN100L2013	(for ELLISSE FL small)*
SIN100L2014	(for ELLISSE FL large)*
SIN100L2015	(for ELLISSE FL xl)*
SIN100L2016	(for TONDO FL)*
SIN100L2017	(for NAXOS FL)

SIN120L2001	(for KOOL XL FL)*
SIN120L2002	(for CIRCUS43 FL)*
SIN120L2003	(for CIRCUS50 FL)
SIN120L2004	(for OPEN)*
SIN120L2005	(for ITALY FL)
SIN120L2006	(for RIV FL)
SIN120L2007	(for KOSTA I)*
SIN120L2008	(for KOSTA II)*
SIN120L2009	(for RX)*
SIN120L2010	(for VOLCANO FL)
SIN120L2011	(for JIMMY FL)*
SIN120L2012	(for JIMMY IN)
SIN120L2013	(for ELLISSE FL small)*
SIN120L2014	(for ELLISSE FL large)*
SIN120L2015	(for ELLISSE FL xl)*
SIN120L2016	(for TONDO FL)*
SIN120L2017	(for NAXOS FL)

(*) PER FORO RUBINETTO AGGIUNGERE AL CODICE DELL'ARTICOLO / FOR TAP HOLE PLEASE ADD TO PRODUCT CODE:

M = monoforo/1 hole | **3F** = 3 fori/3 holes

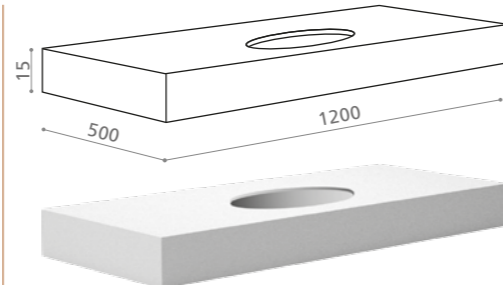
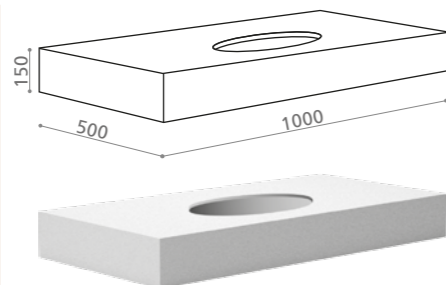
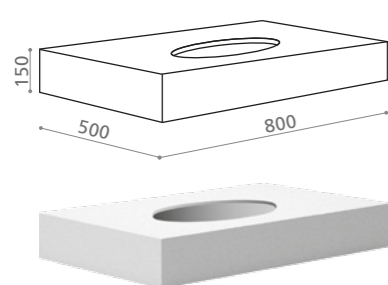

gloss white code:

SIN80L0101	(for KOOL XL FL)*
SIN80L0102	(for CIRCUS43 FL)*
SIN80L0103	(for CIRCUS50 FL)
SIN80L0104	(for OPEN)*
SIN80L0105	(for ITALY FL)
SIN80L0106	(for RIV FL)
SIN80L0107	(for KOSTA I)*
SIN80L0108	(for KOSTA II)*
SIN80L0109	(for RX)*
SIN80L0110	(for VOLCANO FL)
SIN80L0111	(for JIMMY FL)*
SIN80L0112	(for JIMMY IN)
SIN80L0113	(for ELLISSE FL small)*
SIN80L0114	(for ELLISSE FL large)*
SIN80L0115	(for ELLISSE FL xl)*
SIN80L0116	(for TONDO FL)*
SIN80L0117	(for NAXOS FL)

SIN100L0101	(for KOOL XL FL)*
SIN100L0102	(for CIRCUS43 FL)*
SIN100L0103	(for CIRCUS50 FL)
SIN100L0104	(for OPEN)*
SIN100L0105	(for ITALY FL)
SIN100L0106	(for RIV FL)
SIN100L0107	(for KOSTA I)*
SIN100L0108	(for KOSTA II)*
SIN100L0109	(for RX)*
SIN100L0110	(for VOLCANO FL)
SIN100L0111	(for JIMMY FL)*
SIN100L0112	(for JIMMY IN)
SIN100L0113	(for ELLISSE FL small)*
SIN100L0114	(for ELLISSE FL large)*
SIN100L0115	(for ELLISSE FL xl)*
SIN100L0116	(for TONDO FL)*
SIN100L0117	(for NAXOS FL)

SIN120L0101	(for KOOL XL FL)*
SIN120L0102	(for CIRCUS43 FL)*
SIN120L0103	(for CIRCUS50 FL)
SIN120L0104	(for OPEN)*
SIN120L0105	(for ITALY FL)
SIN120L0106	(for RIV FL)
SIN120L0107	(for KOSTA I)*
SIN120L0108	(for KOSTA II)*
SIN120L0109	(for RX)*
SIN120L0110	(for VOLCANO FL)
SIN120L0111	(for JIMMY FL)*
SIN120L0112	(for JIMMY IN)
SIN120L0113	(for ELLISSE FL small)*
SIN120L0114	(for ELLISSE FL large)*
SIN120L0115	(for ELLISSE FL xl)*
SIN120L0116	(for TONDO FL)*
SIN120L0117	(for NAXOS FL)

(*) PER FORO RUBINETTO AGGIUNGERE AL CODICE DELL'ARTICOLO / FOR TAP HOLE PLEASE ADD TO PRODUCT CODE:

M = monoforo/1 hole | **3F** = 3 fori/3 holes

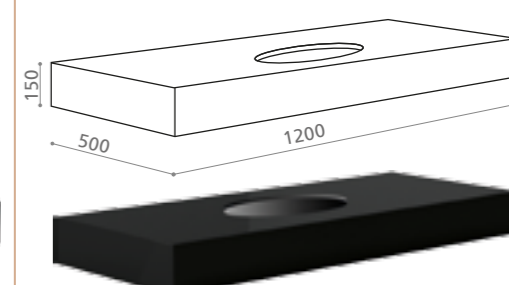
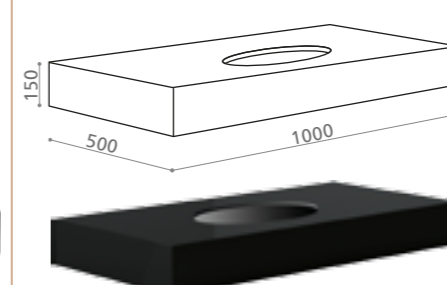
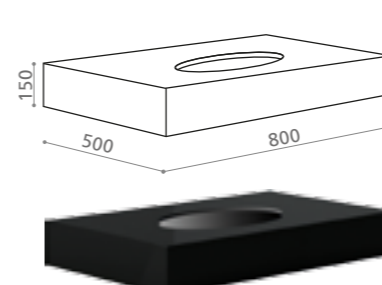

gloss black code:

SIN80L3001	(for KOOL XL FL)*
SIN80L3002	(for CIRCUS43 FL)*
SIN80L3003	(for CIRCUS50 FL)
SIN80L3004	(for OPEN)*
SIN80L3005	(for ITALY FL)
SIN80L3006	(for RIV FL)
SIN80L3007	(for KOSTA I)*
SIN80L3008	(for KOSTA II)*
SIN80L3009	(for RX)*
SIN80L3010	(for VOLCANO FL)
SIN80L3011	(for JIMMY FL)*
SIN80L3012	(for JIMMY IN)
SIN80L3013	(for ELLISSE FL small)*
SIN80L3014	(for ELLISSE FL large)*
SIN80L3015	(for ELLISSE FL xl)*
SIN80L3016	(for TONDO FL)*
SIN80L3017	(for NAXOS FL)

SIN100L3001	(for KOOL XL FL)*
SIN100L3002	(for CIRCUS43 FL)*
SIN100L3003	(for CIRCUS50 FL)
SIN100L3004	(for OPEN)*
SIN100L3005	(for ITALY FL)
SIN100L3006	(for RIV FL)
SIN100L3007	(for KOSTA I)*
SIN100L3008	(for KOSTA II)*
SIN100L3009	(for RX)*
SIN100L3010	(for VOLCANO FL)
SIN100L3011	(for JIMMY FL)*
SIN100L3012	(for JIMMY IN)
SIN100L3013	(for ELLISSE FL small)*
SIN100L3014	(for ELLISSE FL large)*
SIN100L3015	(for ELLISSE FL xl)*
SIN100L3016	(for TONDO FL)*
SIN100L3017	(for NAXOS FL)

SIN120L3001	(for KOOL XL FL)*
SIN120L3002	(for CIRCUS43 FL)*
SIN120L3003	(for CIRCUS50 FL)
SIN120L3004	(for OPEN)*
SIN120L3005	(for ITALY FL)
SIN120L3006	(for RIV FL)
SIN120L3007	(for KOSTA I)*
SIN120L3008	(for KOSTA II)*
SIN120L3009	(for RX)*
SIN120L3010	(for VOLCANO FL)
SIN120L3011	(for JIMMY FL)*
SIN120L3012	(for JIMMY IN)
SIN120L3013	(for ELLISSE FL small)*
SIN120L3014	(for ELLISSE FL large)*
SIN120L3015	(for ELLISSE FL xl)*
SIN120L3016	(for TONDO FL)*
SIN120L3017	(for NAXOS FL)

(*) PER FORO RUBINETTO AGGIUNGERE AL CODICE DELL'ARTICOLO / FOR TAP HOLE PLEASE ADD TO PRODUCT CODE:

M = monoforo/1 hole | **3F** = 3 fori/3 holes

Sintesi

Elemento con cassetto *Element with drawer*



I cassetti Glass Design realizzati in legno MDF sono perfettamente coordinabili con la gamma dei pensili e dei piani, creando molteplici combinazioni personalizzate. Sistema di apertura push & pull.

Glass Design drawers in MDF wood, elegantly match tops and suspended tall cabinets, giving life to a variety of custom solutions. Push & pull opening system.

code:	<i>gloss white</i> SINCA80L01	<i>gloss white</i> SINCA100L01	<i>gloss white</i> SINCA120L01
code:	<i>gloss beige</i> SINCA80L20	<i>gloss beige</i> SINCA100L20	<i>gloss beige</i> SINCA120L20
code:	<i>gloss black</i> SINCA80L30	<i>gloss black</i> SINCA100L30	<i>gloss black</i> SINCA120L30
code:	<i>gold leaf 3D</i> SINCA80FO	<i>gold leaf 3D</i> SINCA100FO	<i>gold leaf 3D</i> SINCA120FO
code:	<i>silver leaf 3D</i> SINCA80FA	<i>silver leaf 3D</i> SINCA100FA	<i>silver leaf 3D</i> SINCA120FA

Sintesi

Colonna sospesa reversibile *Suspended reversible tall cabinet*

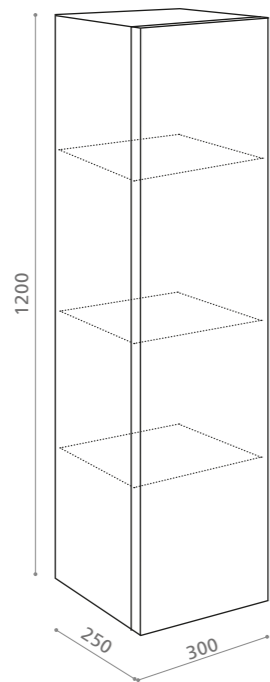

code:



gloss white
SINCO120L01



gloss beige
SINCO120L20



gloss black
SINCO120L30



gold leaf 3D
SINCO120FO



silver leaf 3D
SINCO120FA

“Sotto”

SISTEMA top in vetro “FULL COLOUR GLASS” con lavabo sottopiano
SYSTEM for “FULL COLOUR GLASS” top with undermounted washbasin

Blade

SOTTO

Pert®



Lavabo da incasso in *Pert*® foglia oro. Disponibile su richiesta con foro troppo pieno / *undermounted washbasin Pert*® gold leaf. Available on demand with overflow hole: code **BLASFO**

Cover lavabo foglia oro / *washbasin cover gold leaf*: code **CRFO**

Top in vetro Full Colour Glass nero lucido / *Full Colour Glass top black gloss*: code **TOPG121NL**

Mobile in legno MDF nero lucido / *black gloss furniture in MDF wood*: cm code **SINN120**



Lavabo da incasso in *Pert*® nero opaco. Disponibile su richiesta con foro troppo pieno / *undermounted washbasin Pert*® black mat. Available on demand with overflow hole: code **BLASNO**

Cover lavabo nero opaco / *washbasin cover black mat*: code **CRNO**

Top in vetro Full Colour Glass bianco lucido / *Full Colour Glass top white gloss*: code **TOPG101BL**

Mobile in legno MDF bianco lucido / *white gloss furniture in MDF wood*: code **SINB100**

Four
SOTTO

Pert®

Lavabo da incasso in *Pert*® bianco opaco con foro troppo pieno / *undermounted washbasin Pert*® white mat with overflow hole: code **FOUSBOTP**
Cover lavabo nero opaco / *washbasin cover black mat*: code **CQNO**
Top in vetro Full Colour Glass nero lucido / *Full Colour Glass top black gloss*: code **TOPG101NL**
Mobile in legno MDF nero lucido / *black gloss furniture in MDF wood*: code **SINN100**

Lavabo da incasso in *Pert*® nero opaco con foro troppo pieno / *undermounted washbasin Pert*® black mat with overflow hole: code **FOUSNOTP**
Cover lavabo bianco opaco / *washbasin cover white mat*: code **CQBO**
Top in vetro Full Colour Glass bianco lucido / *Full Colour Glass top white gloss*: code **TOPG101BL**
Mobile in legno MDF bianco lucido / *white gloss furniture in MDF wood*: code **SINB100**



Rho
SOTTO

Pert®



Lavabo da incasso in *Pert®* foglia argento. Disponibile su richiesta con foro troppo pieno / *undermounted washbasin Pert® silver leaf. Available on demand with overflow hole: code RHOSFA*

Cover lavabo foglia argento / *washbasin cover silver leaf: code CTFA*

Top in vetro Full Colour Glass nero lucido / *Full Colour Glass top black gloss: code TOPG121NL*

Mobile in legno MDF nero lucido / *black gloss furniture in MDF wood: code SINN120*



Lavabo da incasso in *Pert®* foglia oro. Disponibile su richiesta con foro troppo pieno / *undermounted washbasin Pert® gold leaf. Available on demand with overflow hole: code RHOSFO*

Cover lavabo foglia oro / *washbasin cover gold leaf: code CTFO*

Top in vetro Full Colour Glass bianco lucido / *Full Colour Glass top white gloss: code TOPG101BL*

Mobile in legno MDF bianco lucido / *white gloss furniture in MDF wood: code SINB100*

Elemento in legno MDF con cassetto foglia oro. Apertura push & pull / *Furniture element with drawer gold leaf in MDF wood. Push & pull opening: code SINCA100FO*

Flou
SOTTO

Florence Glass
ATELIER®



Lavabo da incasso in cristallo foglia oro con troppo pieno / *undermounted crystal washbasin gold leaf with overflow hole*: code **FLOUSFOTPG**
Top in vetro Full Colour Glass bianco opaco / *Full Colour Glass top white mat*: code **TOPG101BO**
Mobile in legno MDF bianco lucido / *white gloss furniture in MDF wood*: code **SINB100**

Bolla SOTTO

Florence Glass
ATELIER®

Lavabo da incasso in cristallo nero lucido con troppo pieno / *undermounted crystal washbasin black gloss with overflow hole*: code **BOLSNLTPG**
Top in vetro Full Colour Glass nero opaco / *Full Colour Glass top black mat*: code **TOPG101NO**
Mobile in legno MDF nero lucido / *black gloss furniture in MDF wood*: code **SINN100**



DA VINCI
TUSCANY 122

IN-OUT

Solutions

123 DA VINCI
TUSCANY



Yacht
SOTTO

TeknoForm®



Lavabo da incasso in TeknoForm® bianco con troppo pieno integrato / *undermounted washbasin TeknoForm® white mat with integrated overflow:*
code **YACHTSBO**

Top in vetro Full Colour Glass nero opaco / *Full Colour Glass top black mat:* code **TOPG121NO**

Mobile in legno MDF nero lucido / *black gloss furniture in MDF wood:* code **SINN120**



Sotto

Top "FULL COLOUR GLASS" con lavabo sottopiano

I Top "Full Colour Glass" sono stati studiati per attribuire semplice eleganza e una perfetta coordinabilità con tutta la gamma delle cassettiere e dei pensili "Sintesi".

Eleganza e design, creativi e funzionali.

I top vengono forniti con foro centrale e lavabo già assemblato nelle finiture scelte garantendo precisione e velocità di installazione.

RIFLESSI PERFETTI E INALTERABILI.

Una nuova materia dalle caratteristiche uniche.

Ottenuto attraverso un procedimento di scioglimento e cristallizzazione di ceramiche e particelle di silicio, un processo molto simile alle condizioni naturali di formazione del granito. Il suo aspetto esteriore invece è molto simile al marmo, ma con caratteristiche di durezza, lucentezza, inassorbenza e resistenza nettamente superiori. Assolutamente omogeneo, inattaccabile da qualsiasi tipo di sostanza acida o alcalina.

La tecnologia e la duttilità di questo materiale consentono di progettare l'ambiente bagno realizzando qualsiasi tipo di misura per assecondare e soddisfare le richieste più esigenti.

- 1 Materiale ecologico per eccellenza, ricavato da elementi naturali, non presenta né resine né solventi.
- 2 Riciclabile al 100%
- 3 Inattaccabile dal calcare
- 4 Colore inalterabile, resistente anche ad esposizioni prolungate ai raggi UV.
- 5 Resistente a qualsiasi prodotto usato per la pulizia del bagno.
- 6 Facile da pulire.

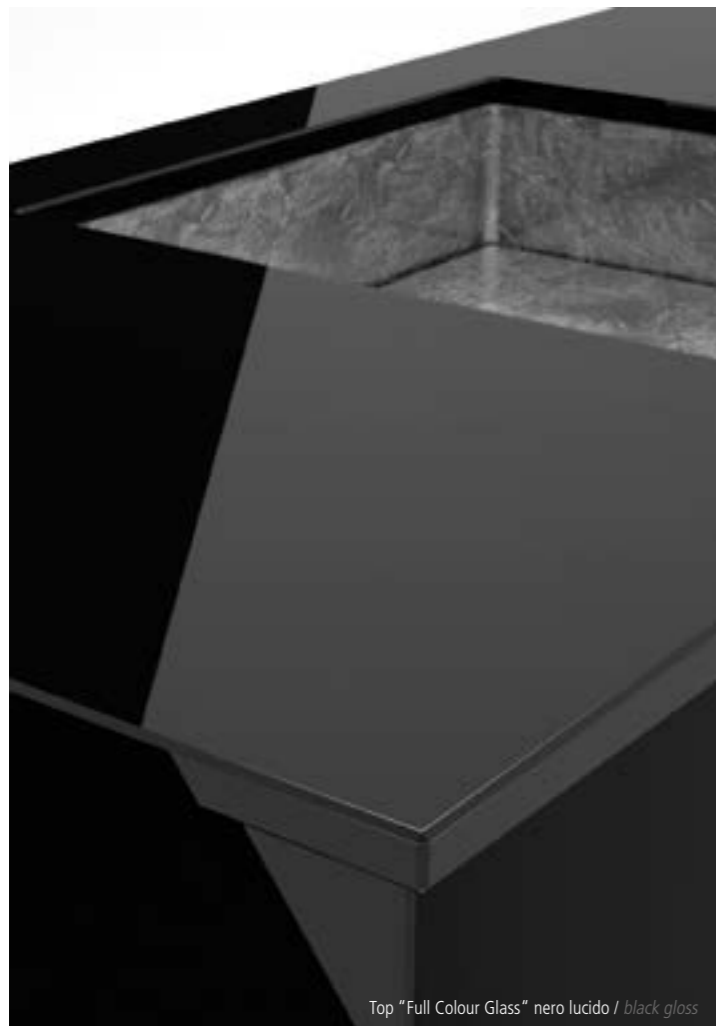

Top "Full Colour Glass" nero lucido / black gloss



Top "Full Colour Glass" nero opaco / black mat

Sotto

"FULL COLOUR GLASS" top with undermounted washbasin

The "Full Colour Glass" Tops are conceived to provide a simple elegance and a perfect fit with the entire drawers and suspended tall cabinets.

Elegance and design, creativity and functionality.

Tops are supplied with central hole and undermounted washbasin already assembled in the chosen finishes, allowing a perfect and easy installation.

PERFECT AND UNALTERABLE REFLECTIONS.

A new material with unique features.

It is obtained through a process of dissolution and crystallization of ceramics and silicon parts. The process is very similar to the natural characteristics of granite formation. Its feature is very similar to marble, but with advantages in terms of hardness, brightness and resistance.

It is homogeneous, durable, acid and alkaline proof.

The technology and the ductility of this material allow to design your bathroom in any customised dimensions in order to meet individual requirements.

1 Ecologic material par excellence, obtained from natural elements, free from resins and from solvents.

2 100% recyclable.

3 Not affected by limestone.

4 Durable colour, resistant to prolonged UV-rays exposition.

5 Resistant to any product used for bathroom cleaning.

6 Easy to clean.



Top "Full Colour Glass" bianco lucido / white gloss



Top "Full Colour Glass" bianco opaco / white mat

Contemporary

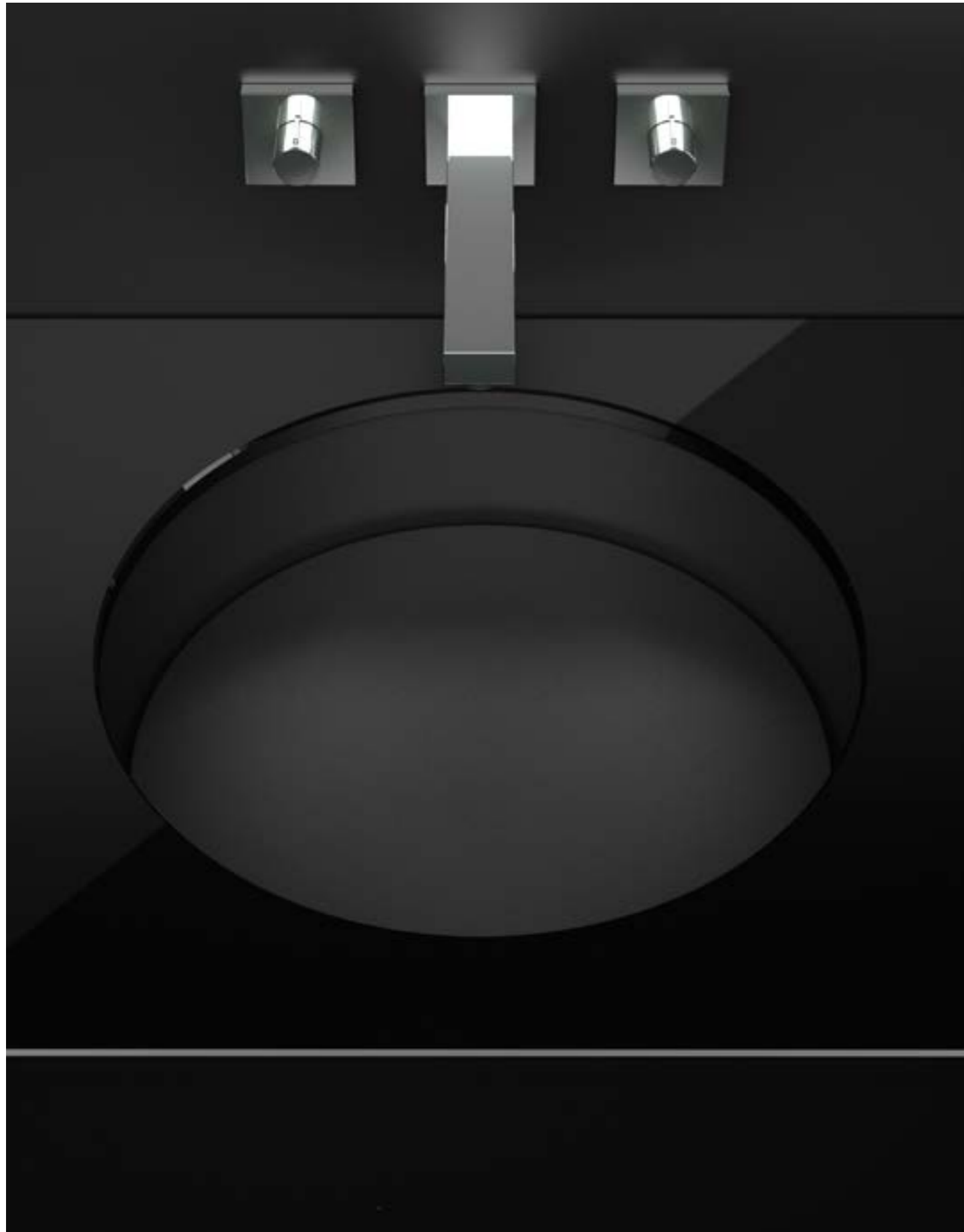

inspirations

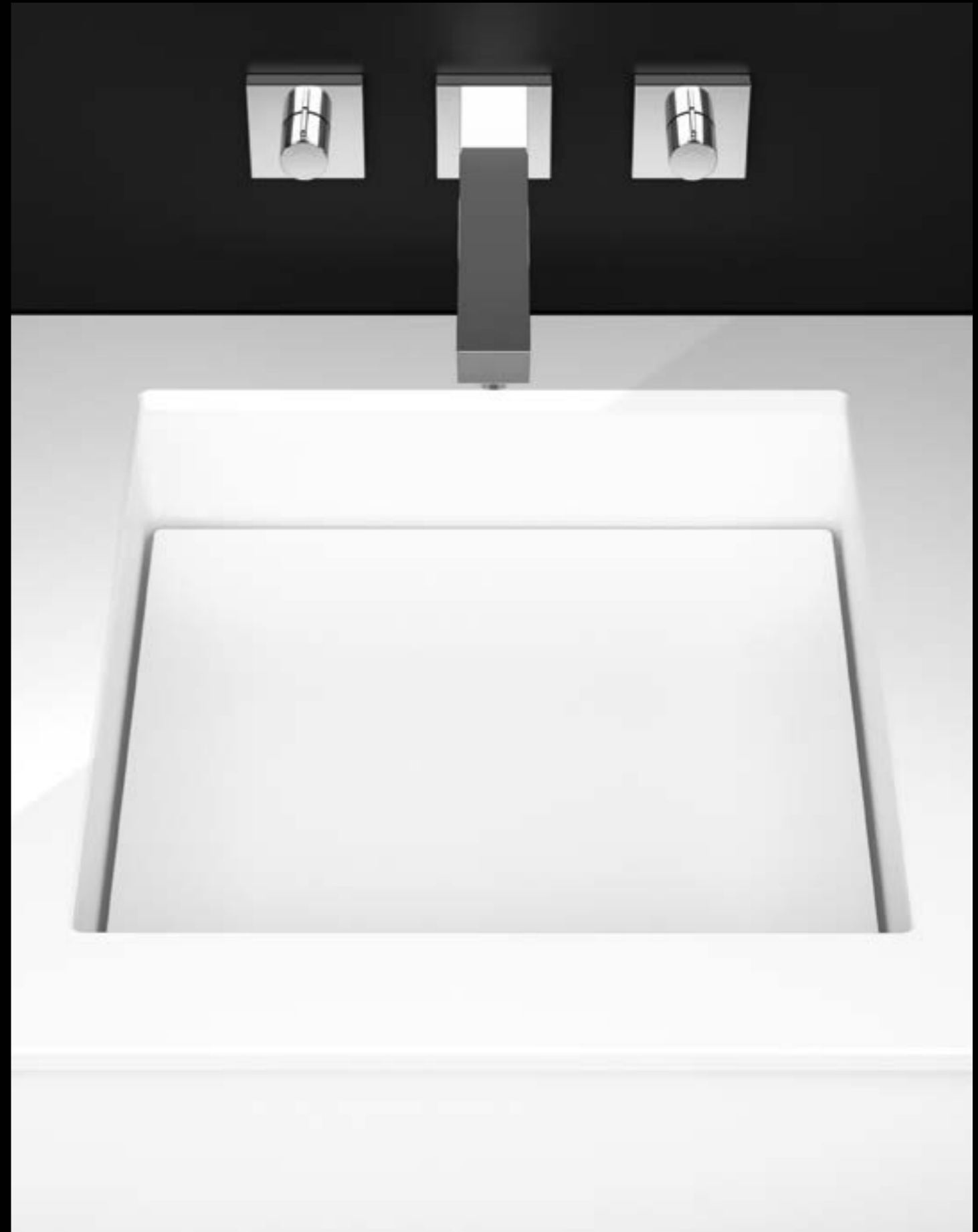

Fashion, Design,

Luxury ... inspirations



Blade SOTTO



A Scegli la dimensione
Choose the size

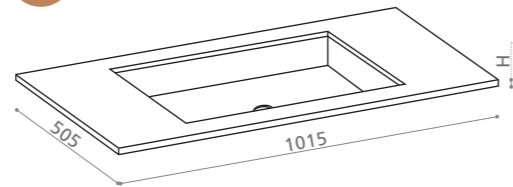

Blade sotto 1015
TOPG101

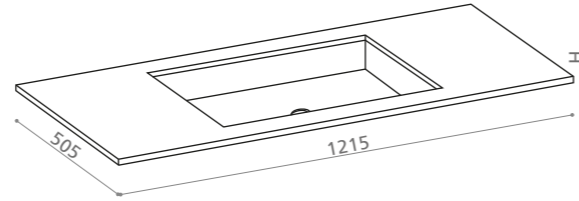

Blade sotto 1215
TOPG121

1

Scegli il colore del TOP in vetro
Choose the colour
Full Colour Glass Top

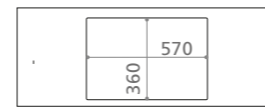

- bianco opaco/white mat
H 12mm code: BO
- bianco lucido/white gloss
H 12mm code: BL
- nero opaco/black mat
H 15mm code: NO
- nero lucido/black gloss
H 15mm code: NL

2

Scegli il colore del lavabo
Choose the washbasin colour
BLADE

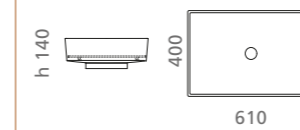

- foglia oro/gold leaf
code: BLASFO
- foglia argento/silver leaf
code: BLASFA
- bianco opaco/white mat
code: BLASBO
- nero opaco/black mat
code: BLASNO

3

Troppo pieno
Joint for overflow

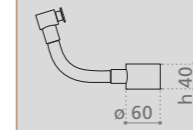

- oro/gold
code: TPG
- cromo/chrome
code: TP

4

Scegli il colore del carabotto
Choose the cover colour



- foglia oro/gold leaf
code: CRFO
- foglia argento/silver leaf
code: CRFA
- bianco opaco/white mat
code: CRBO
- bianco lucido/white gloss
code: CRBL
- nero opaco/black mat
code: CRNO
- nero lucido/black gloss
code: CRNL

5

Scegli il colore e la misura del mobile.
(Comprensivo di attacchi a muro)
Choose colour and size for the
furniture.
(Wall fixing accessories included)

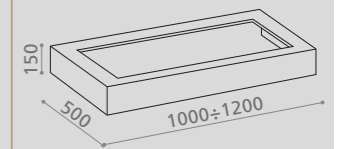

- bianco lucido 100/white gloss
code: SINB100
- bianco lucido 120/white gloss
code: SINB120
- nero lucido 100/black gloss
code: SINN100
- nero lucido 120/black gloss
code: SINN120

Four SOTTO



A Scegli la dimensione
Choose the size

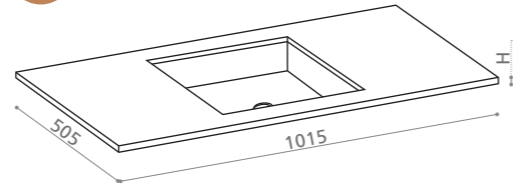

Four sotto 1015
TOPG101

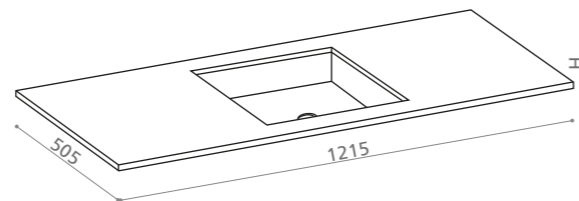

Four sotto 1215
TOPG121

1

Scegli il colore del TOP in vetro
Choose the colour
Full Colour Glass Top

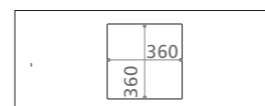

- bianco opaco/white mat
H 12mm code: BO
- bianco lucido/white gloss
H 12mm code: BL
- nero opaco/black mat
H 15mm code: NO
- nero lucido/black gloss
H 15mm code: NL

2

Scegli il colore del lavabo
Choose the washbasin colour
FOUR

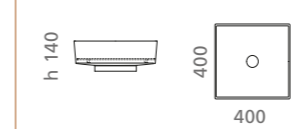

- foglia oro/gold leaf
code: FOUSFO
- foglia argento/silver leaf
code: FOUSFA
- bianco opaco/white mat
code: FOUSBO
- nero opaco/black mat
code: FOUSNO

3

Troppo pieno
Joint for overflow

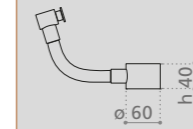

- oro/gold
code: TPG
- cromo/chrome
code: TP

4

Scegli il colore del carabotto
Choose the cover colour



- foglia oro/gold leaf
code: CQFO
- foglia argento/silver leaf
code: CQFA
- bianco opaco/white mat
code: CQBO
- bianco lucido/white gloss
code: CQBL
- nero opaco/black mat
code: CQNO
- nero lucido/black gloss
code: CQNL

5

Scegli il colore e la misura del mobile.
(Comprensivo di attacchi a muro)
Choose colour and size for the
furniture.
(Wall fixing accessories included)

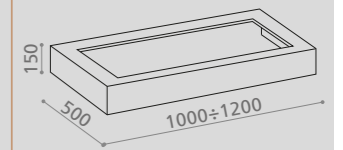

- bianco lucido 100/white gloss
code: SINB100
- bianco lucido 120/white gloss
code: SINB120
- nero lucido 100/black gloss
code: SINN100
- nero lucido 120/black gloss
code: SINN120

Rho SOTTO



A Scegli la dimensione
Choose the size

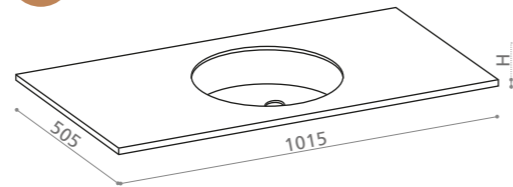

Rho sotto 1015
TOPG101

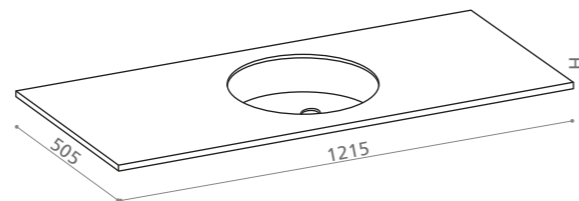

Rho sotto 1215
TOPG121

1

Scegli il colore del TOP in vetro
Choose the colour
Full Colour Glass Top

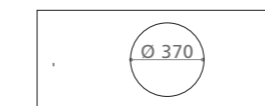

- bianco opaco/white mat
H 12mm code: BO
- bianco lucido/white gloss
H 12mm code: BL
- nero opaco/black mat
H 15mm code: NO
- nero lucido/black gloss
H 15mm code: NL

2

Scegli il colore del lavabo
Choose the washbasin colour
RHO

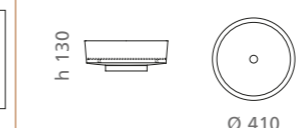

- foglia oro/gold leaf
code: RHOSFO
- foglia argento/silver leaf
code: RHOSFA
- bianco opaco/white mat
code: RHOSBO
- nero opaco/black mat
code: RHOSNO

3

Troppo pieno
Joint for overflow

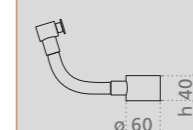

- oro/gold
code: TPG
- cromo/chrome
code: TP

4

Scegli il colore del carabotto
Choose the cover colour

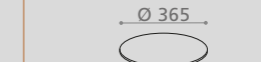

- foglia oro/gold leaf
code: CTFO
- foglia argento/silver leaf
code: CTFA
- bianco opaco/white mat
code: CTBO
- bianco lucido/white gloss
code: CTBL
- nero opaco/black mat
code: CTNO
- nero lucido/black gloss
code: CTNL

5

Scegli il colore e la misura del mobile.
(Comprensivo di attacchi a muro)
Choose colour and size for the
furniture.
(Wall fixing accessories included)

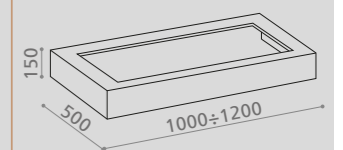

- bianco lucido 100/white gloss
code: SINB100
- bianco lucido 120/white gloss
code: SINB120
- nero lucido 100/black gloss
code: SINN100
- nero lucido 120/black gloss
code: SINN120

Flou SOTTO



A Scegli la dimensione
Choose the size

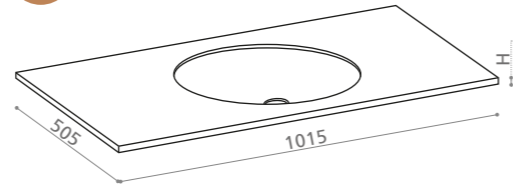

Flou sotto 1015
TOPG101

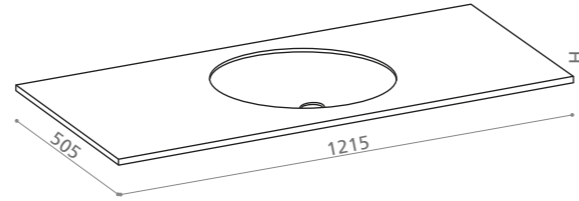

Flou sotto 1215
TOPG121

1

Scegli il colore del TOP in vetro
Choose the colour
Full Colour Glass Top

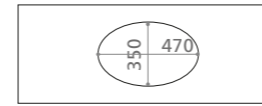

- bianco opaco/white mat
H 12mm code: BO
- bianco lucido/white gloss
H 12mm code: BL
- nero opaco/black mat
H 15mm code: NO
- nero lucido/black gloss
H 15mm code: NL

2

Scegli il colore del lavabo
Choose the washbasin colour
FLOU

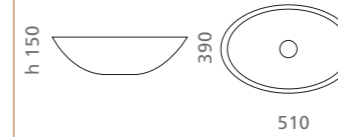

- foglia oro/gold leaf
code: FLOUSFO
- foglia argento/silver leaf
code: FLOUSFA
- nero lucido/black gloss
code: FLOUSNL

3

Troppo pieno
Joint for overflow

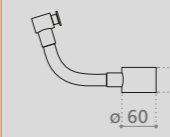

- oro/gold
code: TPG
- cromo/chrome
code: TP

4

Scegli il colore e la misura del mobile.
(Comprensivo di attacchi a muro)
Choose colour and size for the furniture.
(Wall fixing accessories included)

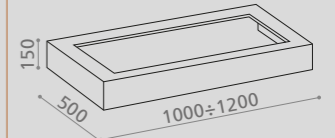

- bianco lucido 100/white gloss
code: SINB100
- bianco lucido 120/white gloss
code: SINB120
- nero lucido 100/black gloss
code: SINN100
- nero lucido 120/black gloss
code: SINN120

Bolla SOTTO



A Scegli la dimensione
Choose the size

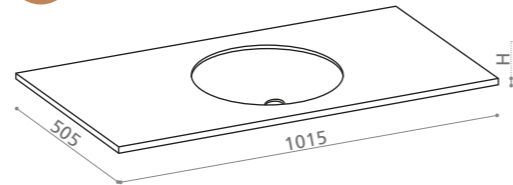

Bolla sotto 1015
TOPG101

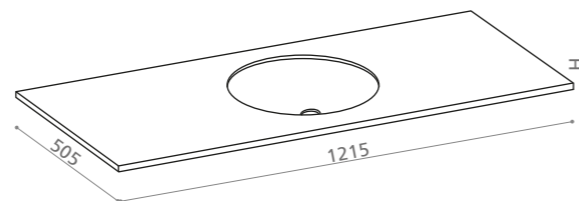

Bolla sotto 1215
TOPG121

1

Scegli il colore del TOP in vetro
Choose the colour
Full Colour Glass Top



- bianco opaco/white mat
H 12mm code: BO
- bianco lucido/white gloss
H 12mm code: BL
- nero opaco/black mat
H 15mm code: NO
- nero lucido/black gloss
H 15mm code: NL

2

Scegli il colore del lavabo
Choose the washbasin colour
BOLLA

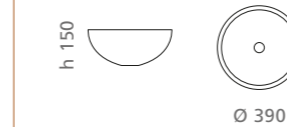

- foglia oro/gold leaf
code: BOLLSFO
- foglia argento/silver leaf
code: BOLLSFA
- nero lucido/black gloss
code: BOLLSNL

3

Troppo pieno
Joint for overflow

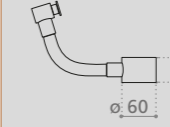

- oro/gold
code: TPG
- cromo/chrome
code: TP

4

Scegli il colore e la misura del mobile.
(Comprensivo di attacchi a muro)
Choose colour and size for the furniture.
(Wall fixing accessories included)

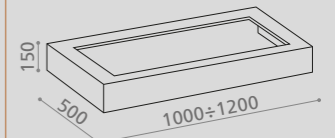

- bianco lucido 100/white gloss
code: SINB100
- bianco lucido 120/white gloss
code: SINB120
- nero lucido 100/black gloss
code: SINN100
- nero lucido 120/black gloss
code: SINN120

Yacht SOTTO



A Scegli la dimensione
Choose the size

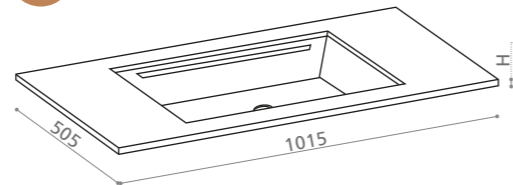

Yacht sotto 1015
TOPG101

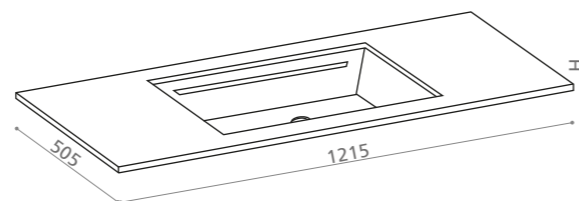

Yacht sotto 1215
TOPG121

1

Scegli il colore del TOP in vetro
Choose the colour
Full Colour Glass Top

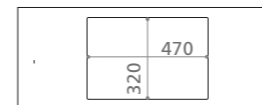

- bianco opaco/white mat
H 12mm code: BO
- bianco lucido/white gloss
H 12mm code: BL
- nero opaco/black mat
H 15mm code: NO
- nero lucido/black gloss
H 15mm code: NL

2

Scegli il colore del lavabo
Choose the washbasin colour
YACHT

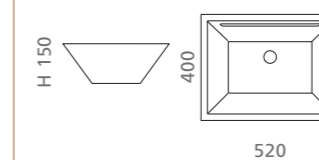

Troppo pieno integrato
Washbasin with integrated overflow

- bianco opaco/white mat
code: YACHTSBO

3

Scegli il colore e la misura del mobile. (Comprensivo di attacchi a muro)
Choose colour and size for the furniture. (Wall fixing accessories included)

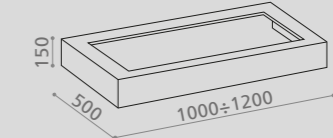

- bianco lucido 100/white gloss
code: SINB100
- bianco lucido 120/white gloss
code: SINB120
- nero lucido 100/black gloss
code: SINN100
- nero lucido 120/black gloss
code: SINN120

Personalizza

Il sistema "SOTTO" Glass Design amplia ulteriormente gli orizzonti della creatività col suo programma di personalizzazione raggiungendo misure e configurazioni estremamente libere.

Il programma prevede la configurazione con uno o più lavabi "SOTTO" quali Blade, Four, Rho, Flou, Bolla e Yacht.

Full Colour Glass Top dimensioni / sizes:

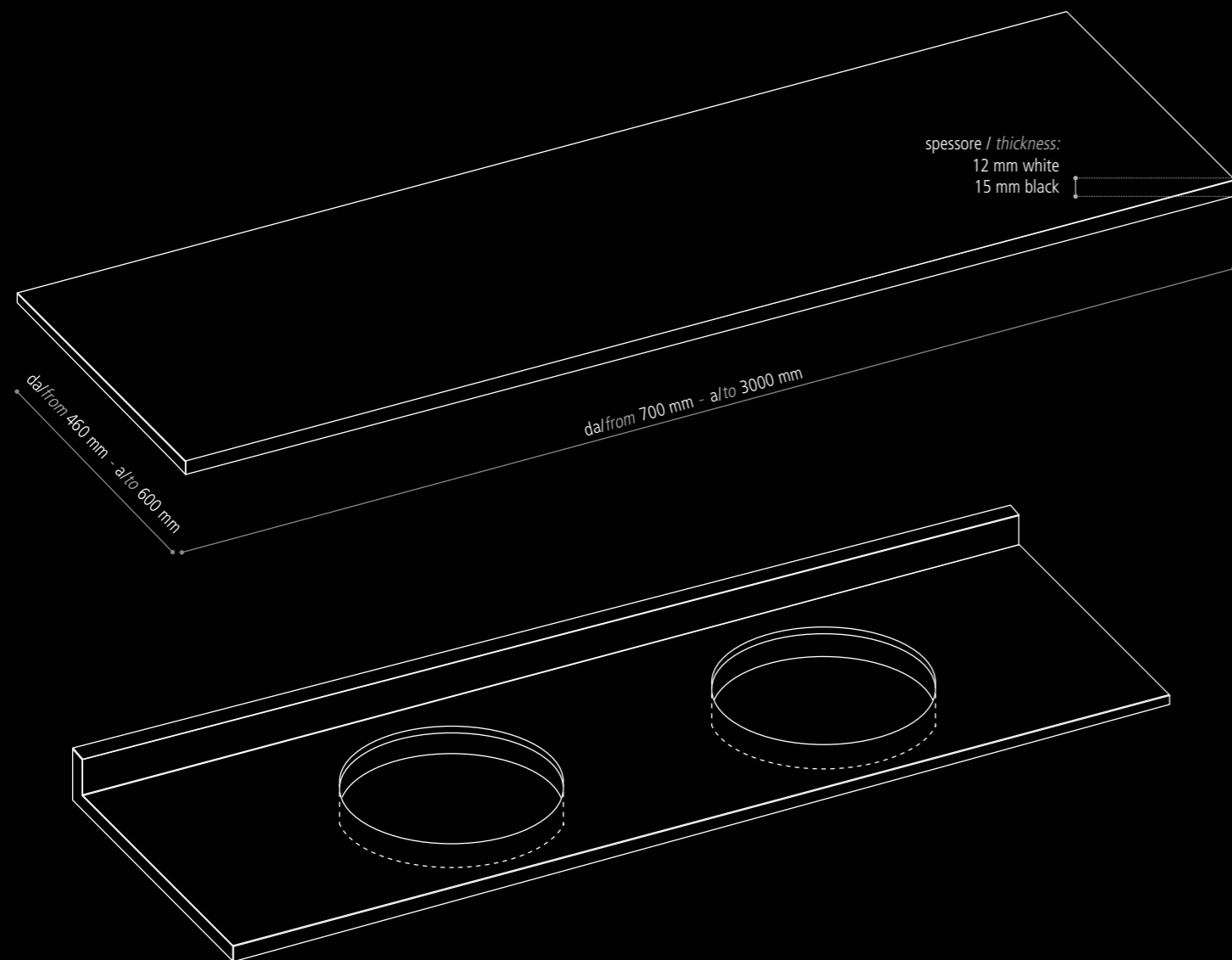

Customise

The new Glass Design "SOTTO" system extends further the creativity with its custom-made program by reaching sizes and solutions "tailor made".

With this program we can combine one or more "Sotto" washbasins: Blade, Four, Rho, Flou, Bolla and Yacht.

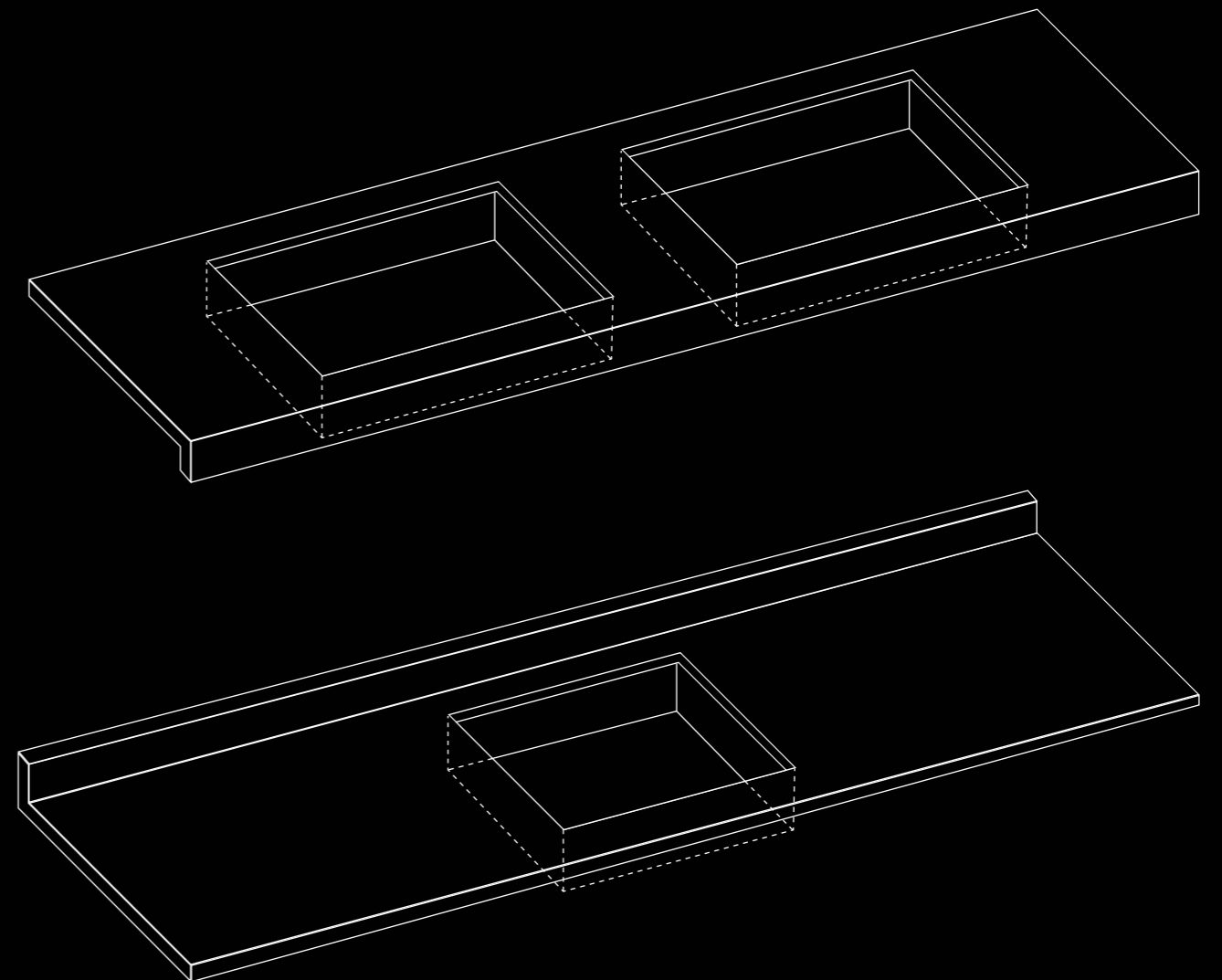

“FULL COLOUR GLASS”

Top con lavabo integrato

Top with integrated washbasin

Full Colour Glass Top dimensioni / sizes:

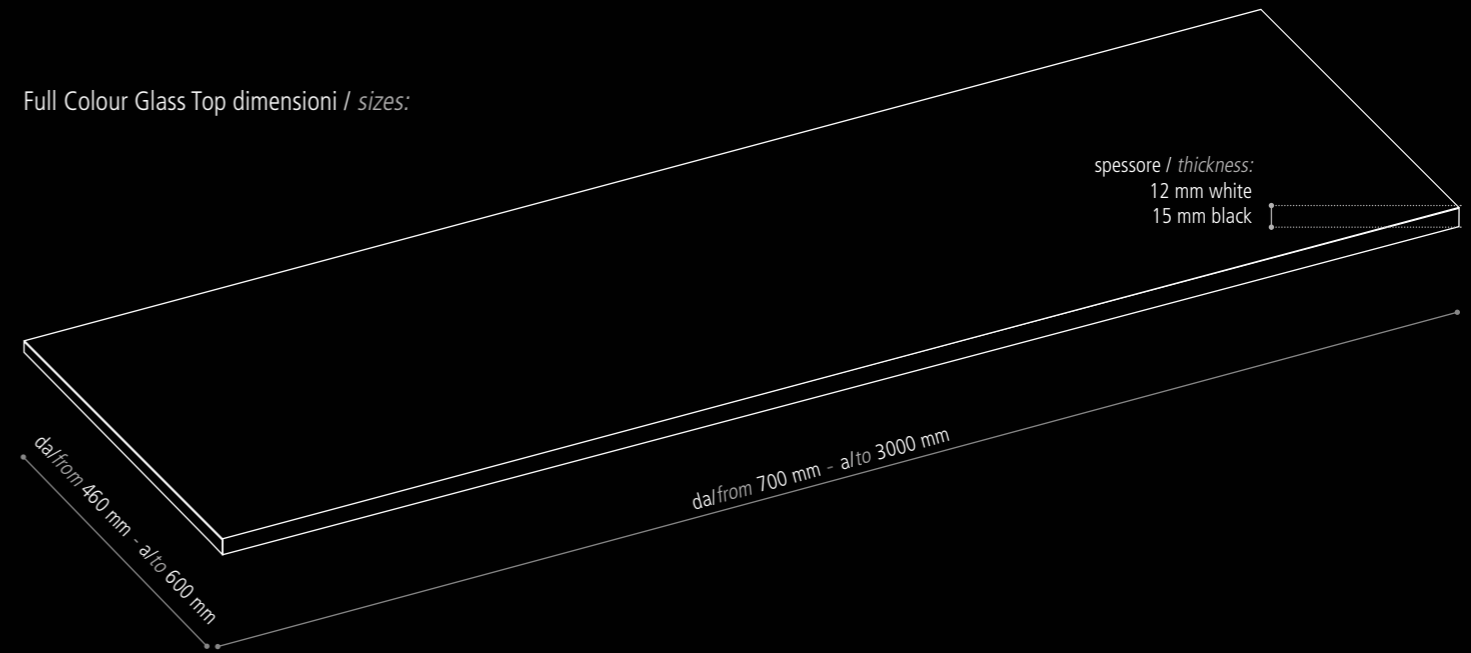

Il sistema “top con lavabi integrati” realizzati a depressione, amplia ulteriormente gli orizzonti della creatività con il suo programma di personalizzazione raggiungendo misure e configurazioni estremamente libere.

Il vetro “Full colour glass” è prodotto interamente in pasta bianca o nera, nelle finiture lucide o opache.

The system for “tops with integral basins” pushes the boundaries of creativity even further thanks to the opportunity for unique and tailor-made sizes and combinations.

The glass used is “Full colour glass” made entirely in white or black and featuring gloss or matt finishes.

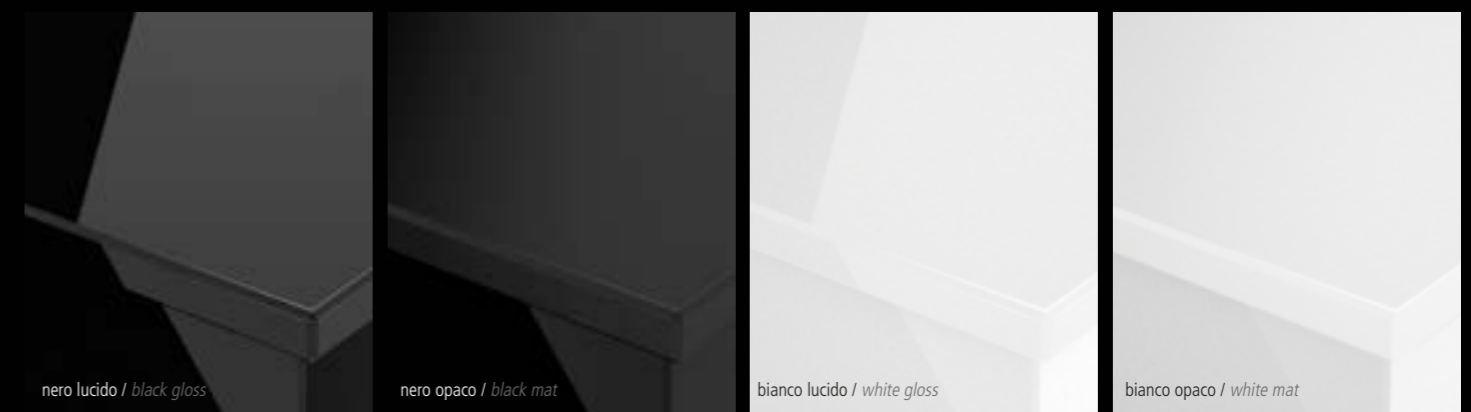

Le immagini qui sotto riportate costituiscono solo alcuni esempi di possibili realizzazioni.

The images below are just a few representative examples of the design possibilities available.







MOBILI FURNITURE SOLUTIONS

Il lusso nel piccolo *A luxury space saving solution*

La nostra filosofia è creare oggetti che al di là della loro dimensione possono suscitare emozioni e al tempo stesso siano pratici e tecnicamente funzionali. *Our philosophy is to create objects that stir up emotions larger than their size while at the same time exhibiting technical functionality and practicality. We have created*
Abbiamo pensato ad un prodotto adatto anche agli spazi più contenuti, riuscendo a realizzare mobili in stile moderno, classico e contemporaneo che potessero impreziosire anche il bagno più piccolo. *a product suitable for even the smallest of spaces, managing to create furniture in classic, contemporary and modern styles that will enrich even the smallest bathroom.*

“Monnalisa”

Affascinante come il concetto che lo ha ispirato.

As fascinating as the concept that inspires it.



Monnalisa Prestige

design by: Giacomo Masoni





Monnalisa

PRESTIGE FLOWer red Ferrari

- **MOBILE:**
legno laccato nero lucido, gambe e cornice finitura platino, pomolo cristallo Fiore trasparente/cromo
- **LAVABO:**
FLOWer in Pert® rosso Ferrari con piletta cromo.
Misure: Ø46 - H 30
- **FURNITURE:**
Black gloss lacquered wood, legs and mirror frame platinum finish, crystal knob Fiore clear/chrome
- **WASHBASIN:**
FLOWer Pert® Ferrari red with chrome waste.
Sizes: Ø46 - H 30

code PRNPLPLFLRFITF4

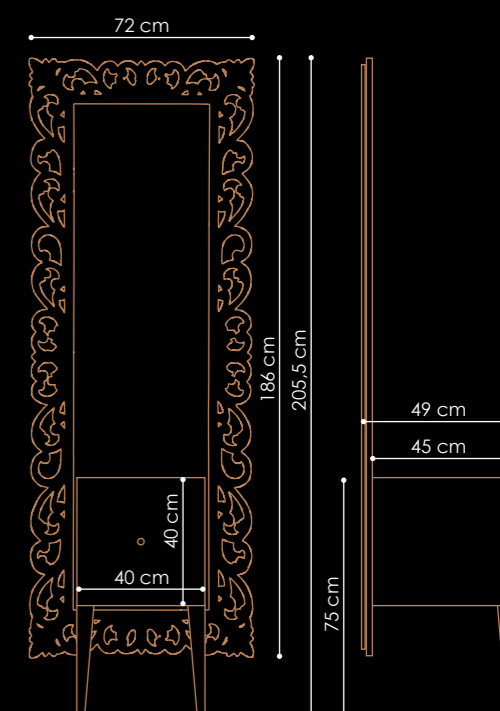



Monnalisa

PRESTIGE FLOWer red Ferrari

- **MOBILE:**
Legno laccato nero lucido, gambe e cornice finitura platino, pomolo cristallo Fiore trasparente/cromo
- **LAVABO:**
FLOWer in Pert® rosso Ferrari con piletta cromo.
Misure: Ø46 - H 30

- **FURNITURE:**
Black gloss lacquered wood, legs and mirror frame platinum finish, crystal knob Fiore clear/chrome
- **WASHBASIN:**
FLOWer Pert® Ferrari red with chrome waste.
Sizes: Ø46 - H 30

code PRNPLPLFLRFITF4



Monnalisa

PRESTIGE FLOWer platinum

- **MOBILE:**
Legno laccato bianco lucido, gambe e cornice finitura platino, pomolo cristallo Fiore trasparente/cromo.
- **LAVABO:**
FLOWer in Pert® platino con piletta cromo.
Misure: Ø46 - H 30

- **FURNITURE:**
white gloss lacquered wood, legs and mirror frame platinum finish, crystal knob Fiore clear/chrome.
- **WASHBASIN:**
FLOWer Pert® platinum with chrome waste.
Sizes: Ø46 - H 30

code PRBPLPLFLPLFITF4



Monnalisa

PRESTIGE FLOWer black

- **MOBILE:**
legno laccato nero lucido, gambe e cornice finitura argento, pomolo cristallo Fiore trasparente/cromo.
- **LAVABO:**
FLOWer in Pert® nero lucido con piletta cromo.
Misure: Ø46 - H 30

- **FURNITURE:**
black gloss lacquered wood, legs and mirror frame silver finish, crystal knob Fiore clear/chrome.
- **WASHBASIN:**
FLOWer Pert® black gloss with chrome waste.
Sizes: Ø46 - H 30

code PRNARARFLNFITF4



Monnalisa

PRESTIGE FLOWer white

- **MOBILE:**
legno laccato bianco lucido, gambe e cornice finitura argento, pomolo cristallo Fiore trasparente/cromo.
- **LAVABO:**
FLOWer in Pert® bianco lucido con piletta cromo.
Misure: Ø46 - H 30

- **FURNITURE:**
white gloss lacquered wood, legs and mirror frame silver finish, crystal knob Fiore clear/chrome.
- **WASHBASIN:**
FLOWer Pert® white gloss with chrome waste.
Sizes: Ø46 - H 30

code PRBARARFLBFITF4

Monnalisa Florence

design by: Giacomo Masoni





Monnalisa

FLORENCE MOSAIC gold

- MOBILE: legno laccato bianco lucido, gambe e cornice finitura foglia oro, pomolo cristallo Sfera trasparente/oro.
 - LAVABO: MOSAIC in TeknoForm® foglia oro con pileta e anello cromo.
- Misure: Ø42 - H 15,8

- FURNITURE: white gloss lacquered wood, legs and mirror frame gold leaf finish, crystal knob Sfera clear/gold.
 - WASHBASIN: MOSAIC TeknoForm® gold leaf with chrome waste and base ring.
- Sizes: Ø42 - H 15,8
code FLBFOFOMSFSFTF3

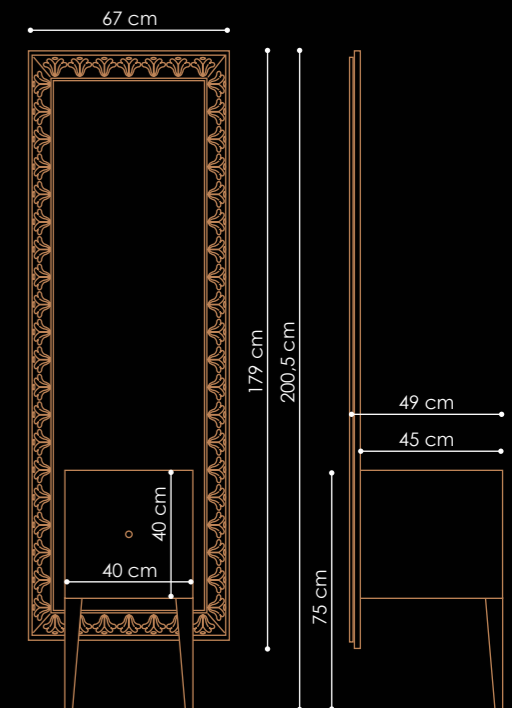

Monnalisa Class

design by: Giacomo Masoni





Monnalisa

CLASS FILIGRANA black/silver

- MOBILE: legno laccato nero lucido, gambe e cornice finitura foglia argento, pomolo cristallo Sfera trasparente/cromo.
 - LAVABO: FILIGRANA in cristallo (Florence Glass Atelier®) nero/foglia argento con piletta cromo (oro su richiesta).
- Misure: Ø40 - H 15
- FURNITURE: black gloss lacquered wood, legs and mirror frame silver leaf finish, crystal knob Sfera clear/chrome.
 - WASHBASIN: FILIGRANA crystal (Florence Glass Atelier®) black/silver leaf with chrome waste (gold waste upon demand). Sizes: Ø40 - H 15

code CLNFAFAFILBSSFTF4



Monnalisa

CLASS FILIGRANA white/gold

- MOBILE: legno laccato bianco lucido, gambe e cornice finitura foglia oro, pomolo cristallo Sfera trasparente/oro.
 - LAVABO: FILIGRANA in cristallo (Florence Glass Atelier®) bianco/foglia oro con piletta e anello cromo. Piletta e anello oro su richiesta.
- Misure: Ø40 - H 16,3

- FURNITURE: white gloss lacquered wood, legs and mirror frame gold leaf finish, crystal knob Sfera clear/gold.
 - WASHBASIN: FILIGRANA crystal (Florence Glass Atelier®) white/gold leaf with chrome waste and base ring. Gold waste and gold ring upon demand.
- Sizes: Ø40 - H 16,3

code CLBFOFOFILWGSFTF3

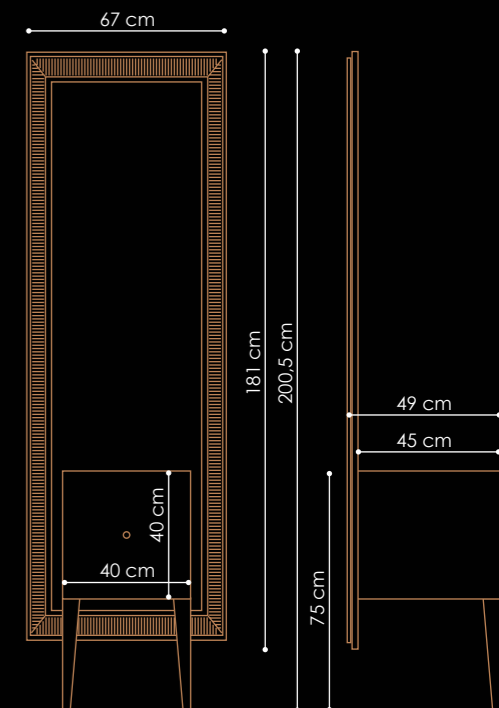

“Misura”

Raccordi essenziali.

The essential joint.



MISURA UNO

MISURA UNO Clivia

- MOBILE: Legno laccato platino, chiusura slow motion, pomolo Madreperla Perla Quadro bianco
- LAVABO: Clivia cristallo 24% pb trasparente (Cristallo de' Medici®) con piletta e anello cromo. Misura: Ø 40-H 11 cm

- FURNITURE: platinum lacquered wood with slow motion hinges, Mother of Pearl knob Perla Quadro white.
- WASHBASIN: Clivia clear crystal 24% pb (Cristallo de' Medici®) with chrome waste and base ring. Size: Ø 40-H 11 cm
code MS1PLPLCLIT01PQW

- SPECCHIO: Legno laccato platino. Misure 120x67cm
- MIRROR FRAME: platinum lacquered wood. Size 120x67cm
code MSMIR120X67PL



MISURA UNO Venice

- **MOBILE:**
Legno laccato bianco opaco, chiusura Slow Motion.
Pomolo Madreperla Quadro bianco
- **LAVABO:**
VENICE - cristallo (Florence Glass Atelier®) finitura nero/argento con piletta e anello cromo. Misura: Ø 40-H 16,3cm
- **FURNITURE:**
White mat lacquered wood with slow motion hinges.
Mother of Pearl knob Quadro white.
- **WASHBASIN:**
VENICE crystal (Florence glass Atelier®) black/silver finish with chrome waste and base ring. Size: Ø 40-h 16,3 cm

code MS1BOBOVN40ANPQW

- **SPECCHIO:**
legno laccato bianco opaco. Misure 120x67cm
- **MIRROR FRAME:**
White mat lacquered wood. Size 120x67cm

code MSMIR120X67B

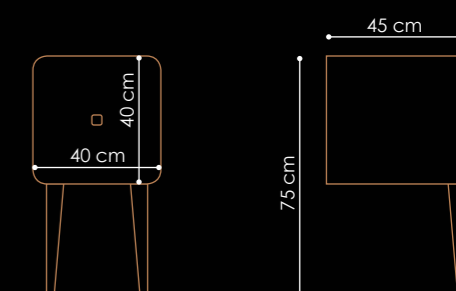

MISURA DUE

MISURA DUE Exté

- MOBILE: legno laccato nero opaco, chiusura Slow Motion. Pomolo Madreperla Quadro smoke.
- SPECCHIO: legno laccato nero opaco.
- LAVABO: Exté in Alumix® finitura nero/argento con piletta cromo. Misura: Ø42 - H 14,5cm

- FURNITURE: black mat lacquered wood with slow motion hinges. Mother of Pearl knob Quadro smoke.
- MIRROR FRAME: black mat lacquered wood.
- WASHBASIN: Exté Alumix® black/silver finish with chrome waste. Size: Ø42 - H 14,5cm

code MS2NONONOEX02PQS

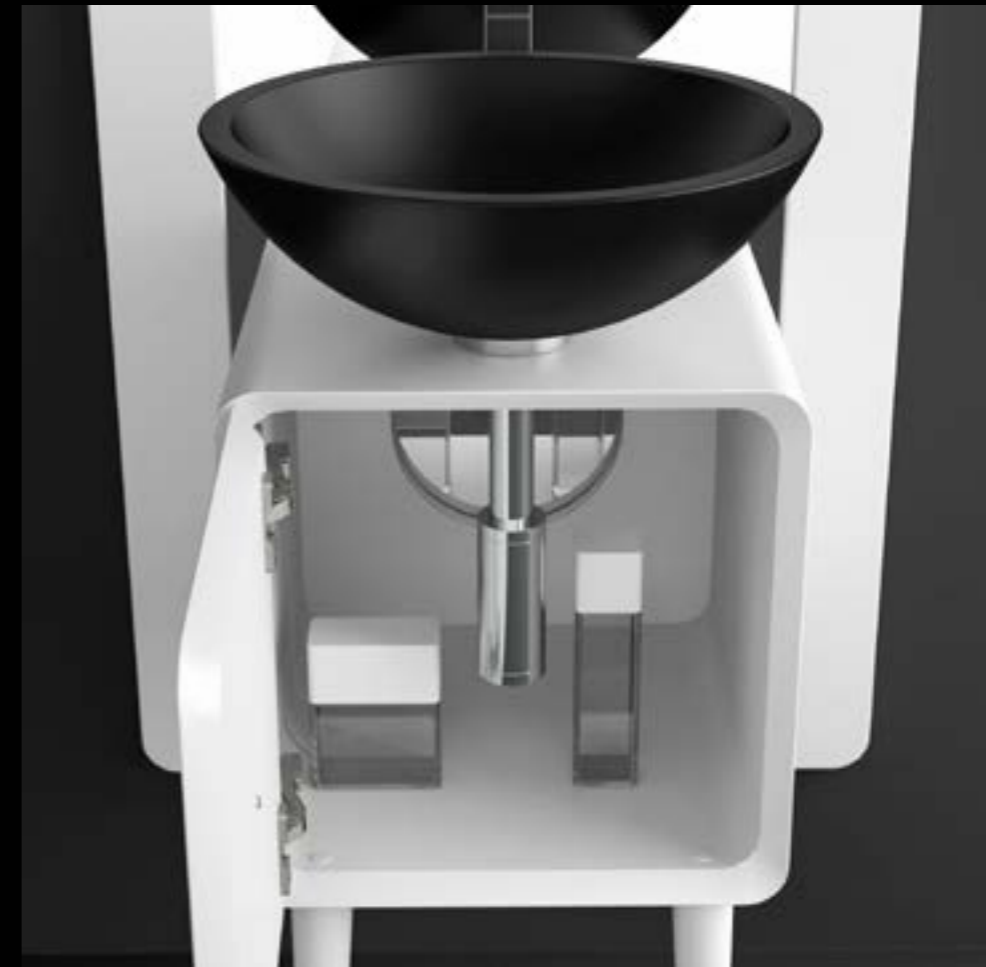

MISURA DUE Circus 43

- **MOBILE:**
Legno laccato bianco opaco, chiusura Slow Motion.
Pomolo Madreperla Quadro
- **SPECCHIO:**
legno laccato bianco opaco.
- **LAVABO:** Circus 43 in Vetrofreddo® nero opaco con piletta e anello cromo. Misura: D43 – H 15,3cm
- **FURNITURE:**
White mat lacquered wood with slow motion hinges.
Mother of Pearl knob Quadro.
- **MIRROR FRAME:**
White mat lacquered wood.
- **WASHBASIN:** Circus 43 Vetrofreddo® black mat finish with chrome waste and base ring. Size: D43 –H 15,3cm

code MS2BOBOBOC43NPQS

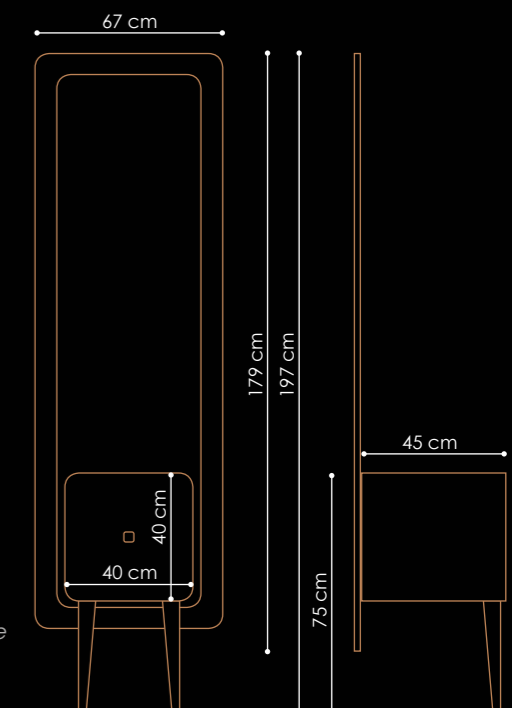

MISURA TRE

MISURA TRE Flou

- MOBILE: legno laccato bianco opaco, chiusura Slow Motion. Pomoli Madreperla Quadro bianco.
- LAVABO: Flou in Vetrofreddo® nero opaco con piletta e anello cromo. Misura: 57x37,5 H 13,3cm

- FURNITURE: white mat lacquered wood with slow motion hinges. Mother of Pearl knobs Quadro white.
- WASHBASIN: Flou Vetrofreddo® black mat finish with chrome waste and base ring. Size: 57x37,5 H 13,3cm

code MS3BOBOFLNPQW

- SPECCHIO: legno laccato bianco opaco. Misura 120x67cm
- MIRROR FRAME: white mat lacquered wood. Size 120x67cm

code MSMIR120X67B





MISURA TRE Global Murano

- **MOBILE:** legno laccato nero opaco, chiusura Slow Motion.
Pomoli Madreperla Quadro smoke.
- **LAVABO:** Globall Murano, in vetro di Murano bianco opale con cover bianco, piletta e anello cromo.
Misura: D42 – H 15cm

- **FURNITURE:** Black mat lacquered wood with slow motion hinges.
Mother of Pearl knobs Quadro smoke.
- **WASHBASIN:** Globall Murano (Made with Murano Glass®) opal white with white cover, chrome waste and base ring.
Size: D42 – H15cm

code MS3NONOGBT36PQS

- **SPECCHIO:** legno laccato nero opaco.
Misure 120x67cm
- **MIRROR FRAME:** black mat lacquered wood. Size 120x67cm

code MSMIR120X67N

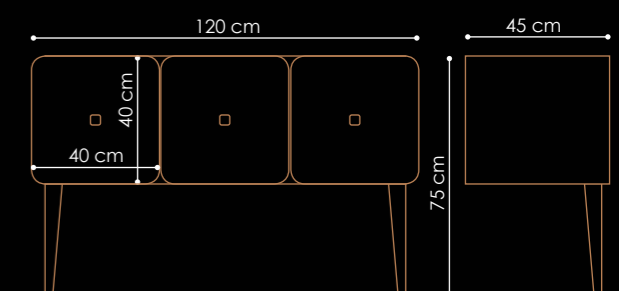

“Leonardo”

Insospettabile fascino della semplicità.

Unexpected charm of simplicity.

CUBUS



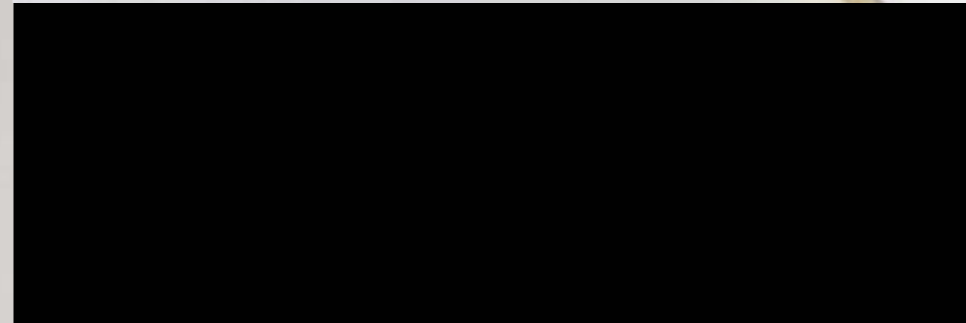

Leonardo
CUBUS
 KOOL MAX black

- **MOBILE:** legno laccato nero lucido.
- **LAVABO:** Kool Max in VetroFreddo® nero opaco con piletta cromo.
- Misure lavabo: L 54 - P 40 - H 15
- Ingombro totale: L 54 - P 45 - H 55
- **FURNITURE:** black gloss lacquered wood.
- **WASHBASIN** Kool Max VetroFreddo® black mat with chrome waste.
- Washbasin sizes: W 54 - D 40 - H 15
- Overall sizes: W 54 - D 45 - H 55

code CUBUSNLKMP030

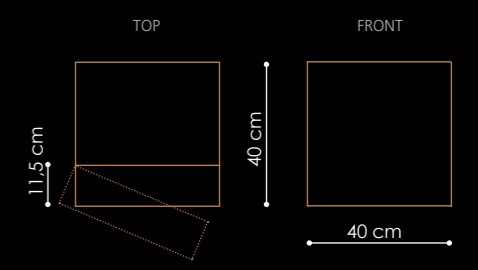



Leonardo

CUBUS KOOL MAX white

- MOBILE: legno laccato bianco lucido.
 - LAVABO: Kool Max in VetroFreddo® bianco opaco con piletta cromo.
- Misure lavabo: L 54 - P 40 - H 15
Ingombro totale: L 54 - P 45 - H 55

- FURNITURE: white gloss lacquered wood.
 - WASHBASIN: Kool Max VetroFreddo® white mat with chrome waste.
- Washbasin sizes: W 54 - D 40 - H 15
Overall sizes: W 54 - D 45 - H 55

code CUBUSBLKMP001



Leonardo

CUBUS KOOL MAX white

- MOBILE: legno laccato nero lucido.
 - LAVABO: Kool Max VetroFreddo® bianco opaco con piletta cromo.
- Misure lavabo: L 54 - P 40 - H 15
Ingombro totale: L 54 - P 45 - H 55

- FURNITURE: black gloss lacquered wood.
 - WASHBASIN: Kool Max VetroFreddo® white mat with chrome waste.
- Washbasin sizes: W 54 - D 40 - H 15
Overall sizes: W 54 - D 45 - H 55

code CUBUSNLKMP001



Leonardo

CUBUS KOOL MAX white

- MOBILE: legno finitura foglia oro.
 - LAVABO: Kool Max in VetroFreddo® bianco opaco con piletta cromo.
- Misure lavabo: L 54 - P 40 - H 15
Ingombro totale: L 54 - P 45 - H 55

- FURNITURE: gold leaf finish wood.
 - WASHBASIN: Kool Max VetroFreddo® white mat with chrome waste.
- Washbasin sizes: W 54 - D 40 - H 15
Overall sizes: W 54 - D 45 - H 55

code CUBUSFOKMP001



Leonardo

CUBUS KOOL MAX black

- MOBILE: legno finitura foglia argento.
 - LAVABO: Kool Max VetroFreddo® nero opaco con piletta cromo.
- Misure lavabo: L 54 - P 40 - H 15
Ingombro totale: L 54 - P 45 - H 55

- FURNITURE: silver leaf finish wood.
 - WASHBASIN: Kool Max VetroFreddo® black mat with chrome waste.
- Washbasin sizes: W 54 - D 40 - H 15
Overall sizes: W 54 - D 45 - H 55

code CUBUSFAKMP030

CANTO SMALL





Leonardo

CANTO ICE OVAL Small

- MOBILE: legno laccato nero lucido con cassetto, piano vetro nero, pomolo cristallo Deluxe trasparente/cromo.
- LAVABO: ICE OVAL Small cristallo 24% pb trasparente (Cristallo De' Medici®) con piletta e anello cromo. Misure lavabo: L 43 - P 28 - H 14,3
Ingombro totale: L 61,0 - P 37,5 - H 89,3

• FURNITURE: black gloss lacquered wood with drawer, black glass top, crystal knob Deluxe clear/chrome.

• WASHBASIN: ICE OVAL Small clear crystal 24% pb. (Cristallo De' Medici®) with chrome waste and base ring. Washbasin sizes: W 43 - D 28 - H 14,3
Overall sizes: W 61,0 - D 37,5 - H 89,3

code CANTONLNIOSD1

Specchio tondo laccato nero lucido Ø70
Round mirror black gloss Ø70

code FLOMIRRONL

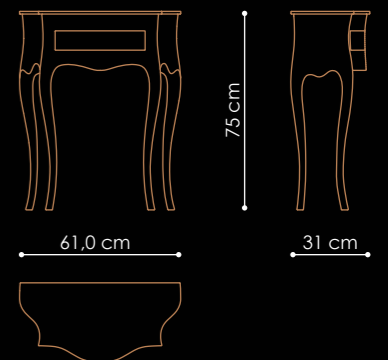



Leonardo

CANTO ICE OVAL Small

- MOBILE: legno laccato bianco lucido con cassetto, piano vetro nero, pomolo cristallo Deluxe nero/cromo.
- LAVABO: ICE OVAL Small cristallo 24% pb nero (®Cristallo De' Medici) con piletta e anello cromo.
Misure lavabo: L 43 - P 28 - H 14,3
Ingombro totale: L 61,5 - P 37,5 - H 89,3

- FURNITURE: white gloss lacquered wood with drawer, black glass top, crystal knob Deluxe black/chrome.
- WASHBASIN: ICE OVAL Small black crystal 24% pb (®Cristallo De' Medici) with chrome waste and base ring.
Washbasin sizes: W 43 - D 28 - H 14,3
Overall sizes: W 61,5 - D 37,5 - H 89,3

code CANTOBLNIOST3DLT3

- Specchio tondo laccato bianco lucido Ø70 cm. Round mirror white gloss Ø70: cod FLOMIRROBL

CANTO XL

Leonardo

CANTO XL FLARE Tech black/silver

- **MOBILE:** legno laccato bianco lucido con due cassetti, piano vetro nero, pomoli cristallo Deluxe trasparente/cromo.
- **LAVABO:** FLARE Tech in cristallo (Florence Glass Atelier®) finitura nero/foglia argento con piletta e anello cromo.
Misure lavabo: Ø40 - H 16,3
Ingombro totale: L 97,5 - P 43 - H 91

- **FURNITURE:** white gloss lacquered wood with two drawers, black glass top, crystal knobs Deluxe clear/chrome.
- **WASHBASIN:** FLARE Tech crystal (Florence Glass Atelier®) black/silver leaf finish with chrome waste and base ring.
Washbasin sizes: Ø40 - H 16,3
Overall sizes: W 97,5 - D 43 - H 91

Specchio tondo laccato bianco lucido Ø 70
Round mirror white glass Ø 70

code CANTOXLBNFTBSDLT

code FLOMIRROBL



Leonardo

CANTO XL ICE OVAL

- **MOBILE:** legno laccato nero lucido con due cassetti, piano vetro nero, pomoli cristallo Deluxe trasparente/cromo.
 - **LAVABO:** ICE OVAL cristallo 24% pb trasparente (Cristallo De' Medici®) con piletta e anello cromo.
- Misure lavabo: L 51 - P 34,5 - H 16,8
Ingombro totale: L 97,5 - P 40,5 - H 92

- **FURNITURE:** black gloss lacquered wood with two drawers, black glass top, crystal knobs Deluxe clear/chrome.
 - **WASHBASIN:** ICE OVAL clear crystal 24%pb (Cristallo De' Medici®) with chrome waste and base ring.
- Washbasin sizes: W 51 - D 34,5 - H 16,8
Overall sizes: W 97,5 - D 40,5 - H 92

code CANTOXLNLIOT1DLT

Specchio ovale laccato nero lucido 95 x 65cm
Oval mirror black gloss 95 x 65cm

code FLOMIROVNL

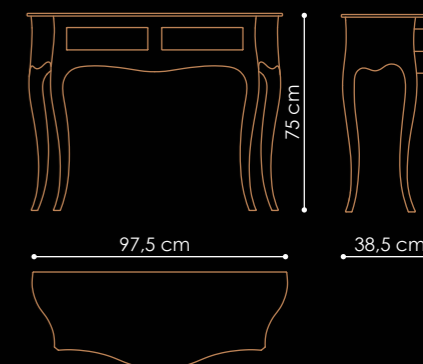

KOIN MEDIO





Leonardo

KOIN MEDIO RHO White

- MOBILE: legno laccato bianco lucido, piano vetro nero.
- LAVABO: Rho in Pert @ finitura bianco lucido con piletta cromo.
Misura lavabo Ø 41 - H 13cm
Ingombro totale L 41 - P 53,5 - H 56cm

- FURNITURE: white lacquered wood with black glass top.
- WASHBASIN: RHO Pert @ white gloss finish with chrome waste.
Washbasin sizes D Ø 41 - H 13cm
Overall sizes W 41 -D 53,5 - H 56cm

code KOINMBLNRHOBL

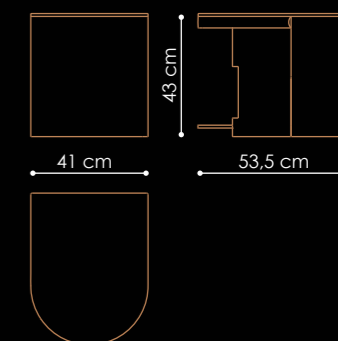



Leonardo

KOIN MEDIO RHO black

- MOBILE: legno laccato inox scuro, piano vetro nero.
 - LAVABO: RHO in Pert® nero lucido con piletta cromo.
- Misure lavabo: Ø41 - H 13
Ingombro totale: L 41 - P 53,5 - H 56

- FURNITURE: dark inox mat lacquered wood, black glass top.
 - WASHBASIN: RHO Pert® black gloss with chrome waste.
- Washbasin sizes: Ø41 - H 13
Overall sizes: W 41 - D 53,5 - H 56

code KOINMDINRHONL



Leonardo

KOIN MEDIO RHO dark inox mat

- MOBILE: legno laccato inox scuro, piano vetro nero.
 - LAVABO: RHO in Pert® finitura Metal inox scuro con piletta cromo.
- Misure lavabo: Ø41 - H 13
Ingombro totale: L 41 - P 53,5 - H 56

- FURNITURE: dark inox mat lacquered wood, black glass top.
 - WASHBASIN: RHO Pert® Metal dark inox mat finish with chrome waste.
- Washbasin sizes: Ø41 - H 13
Overall sizes: W 41 - D 53,5 - H 56

code KOINMDINRHODI



Leonardo

KOIN MEDIO RHO white

- MOBILE: legno laccato nero lucido, piano vetro nero.
 - LAVABO: RHO in Pert® bianco lucido con piletta cromo.
- Misure lavabo: Ø41 - H 13
Ingombro totale: L 41 - P 53,5 - H 56

- FURNITURE: black gloss lacquered wood, black glass top.
 - WASHBASIN: RHO Pert® white gloss with chrome waste.
- Washbasin sizes: Ø41 - H 13
Overall sizes: W 41 - D 53,5 - H 56

code KOINMNLNRHOBL



Leonardo

KOIN MEDIO RHO black

- MOBILE: legno laccato bianco lucido, piano vetro bianco.
 - LAVABO: Rho in Pert® finitura nero lucido con piletta cromo.
- Misura lavabo Ø 41 - H 13cm
Ingombro totale L 41 - P 53,5 - H 56cm

- FURNITURE: white lacquered wood with white glass top.
 - WASHBASIN: RHO Pert® black gloss finish with chrome waste.
- Washbasin sizes D Ø 41 - H 13cm
Overall sizes W 41 - D 53,5 - H 56cm

code KOINMBLBRHONL

KOIN XL



Leonardo

KOIN XL FLOWer red Ferrari

- MOBILE: legno laccato bianco lucido, piano vetro bianco.
 - LAVABO: FLOWER in Pert® rosso Ferrari con piletta cromo.
- Misure lavabo: Ø46 - H 30
Ingombro totale: Ø 46 - H 107

- FURNITURE: white gloss lacquered wood, white glass top.
 - WASHBASIN: FLOWER Pert® Ferrari red with chrome waste.
- Washbasin sizes: Ø46 - H 30
Overall sizes: Ø 46 - H 107

code KOINXLBFLR

code FLOSTYRDW

Vasca da bagno in "Bi-Mat" rosso Ferrari con interno bianco lucido
Bathtub Bi-Mat Ferrari red finish, white gloss inside





Leonardo
KOIN XL
 FLOWer red Ferrari

- MOBILE: legno laccato bianco lucido, piano vetro bianco.
 - LAVABO: FLOWER Pert® rosso Ferrari con piletta cromo.
- Misure lavabo: Ø46 - H 30
 Ingombro totale: Ø 46 - H 107

- FURNITURE: white gloss lacquered wood, white glass top.
 - WASHBASIN: FLOWER Pert® Ferrari red with chrome waste.
- Washbasin sizes: Ø46 - H 30
 Overall sizes: Ø 46 - H 107

code KOINXLBLBFLR

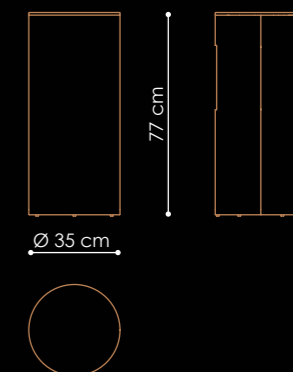



Leonardo

KOIN XL HB white gloss

- MOBILE: legno laccato nero lucido, piano vetro nero.
 - LAVABO: HB in Vetrefreddo ® finitura bianco lucido con piletta cromo.
- Misura lavabo Ø 41,5 - H 18,5cm
Ingombro totale Ø 42 - H96 cm

- FURNITURE: black lacquered wood with black glass top.
 - WASHBASIN: HB Vetrefreddo ® white gloss finish with chrome waste.
- Washbasin sizes D Ø 41,5 - H 18,5cm
Overall sizes Ø 42 - H 96 cm

code KOINXLNLNHBBL



Leonardo

KOIN XL HB white mat

- MOBILE: legno laccato inox scuro, piano vetro nero.
 - LAVABO: HB in Vetrefreddo ® finitura bianco opaco con piletta cromo.
- Misura lavabo Ø 41,5 - H 18,5cm
Ingombro totale Ø 42 - H96 cm

- FURNITURE: dark inox mat lacquered wood with black glass top.
 - WASHBASIN: HB Vetrefreddo ® white mat finish with chrome waste.
- Washbasin sizes Ø 41,5 - H 18,5cm
Overall sizes Ø 42 - H 96 cm

code KOINXLDINHBPO01



Leonardo

KOIN XL HB black mat

- MOBILE: legno laccato platino, piano vetro nero.
 - LAVABO: HB in Vetrefreddo ® finitura nero opaco con piletta cromo.
- Misura lavabo Ø 41,5 - H 18,5cm
Ingombro totale L 42 - H96 cm

- FURNITURE: platinum lacquered wood with black glass top.
 - WASHBASIN: HB Vetrefreddo ® black mat finish with chrome waste.
- Washbasin sizes Ø 41,5 - H 18,5cm
Overall sizes Ø 42 - H 96 cm

code KOINXLPLNHBPO30



Leonardo

KOIN XL HB black gloss

- MOBILE: legno laccato bianco lucido, piano vetro bianco.
 - LAVABO: HB in Vetrefreddo ® finitura nero lucido con piletta cromo.
- Misura lavabo Ø 41,5 - H 18,5cm
Ingombro totale Ø 42 - H96 cm

- FURNITURE: white lacquered wood with white glass top.
 - WASHBASIN: HB Vetrefreddo ® black gloss finish with chrome waste.
- Washbasin sizes Ø 41,5 - H 18,5cm
Overall sizes Ø 42 - H 96 cm

code KOINXLBLBHNL

LUMIERE





Leonardo

LUMIERE LUMIERE

- MOBILE: legno laccato nero lucido, piano vetro nero.
 - LAVABO: Lumiere in cristallo 24%pb trasparente (Cristallo de'Medici®) con piletta cromo.
- Completo di illuminazione Led e trasformatore.
Misura lavabo Ø 33 - H 18cm
Ingombro totale Ø33 - H 86,5 cm

- FURNITURE: black lacquered wood with black glass top.
 - WASHBASIN: LUMIERE in clear crystal 24%pb (Cristallo de'Medici®) with chrome waste.
- Led Lighting set included.
Washbasin sizes Ø 33 - H 18cm
Overall sizes Ø 33 - H 86,5 cm

code LUMIERENT01

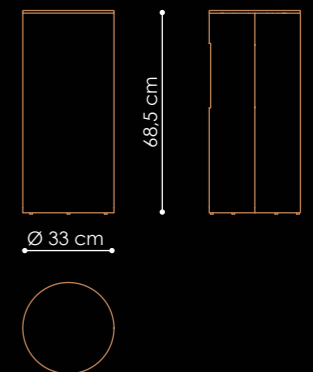

MUSA

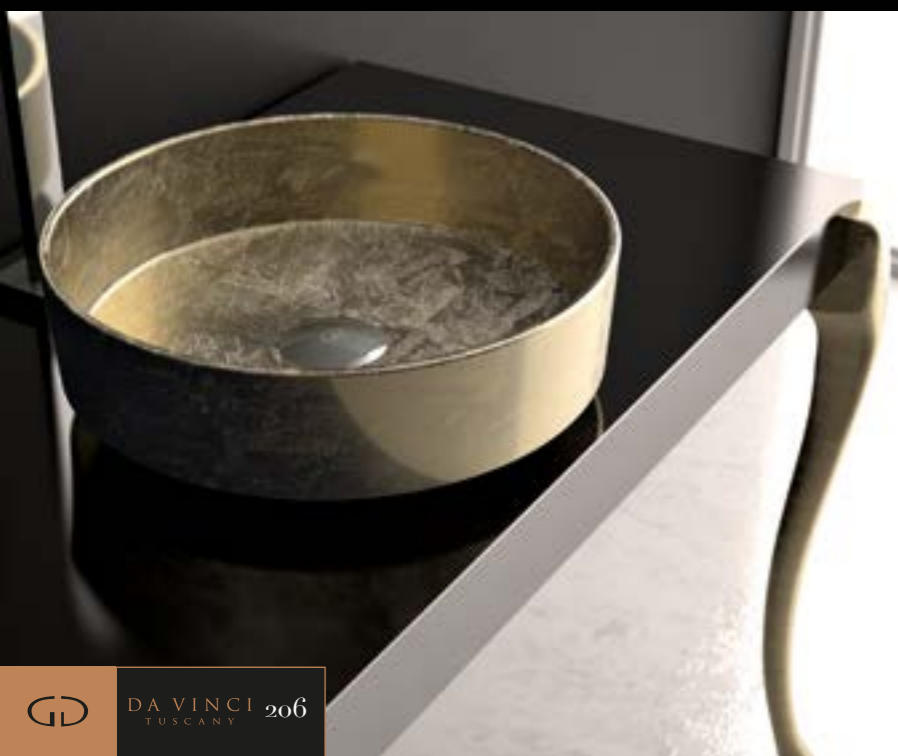

Leonardo

MUSA RHO gold leaf

- CONSOLLE: legno laccato nero lucido con gambe finitura foglia oro. Misure L 112 - P 58,5 - H 75
- LAVABO: RHO in Pert® finitura foglia oro con piletta cromo. Misure D 41 - H 13

- *CONSOLE: black gloss lacquered wood with gold leaf legs. Sizes W 112 - D 58,5 - H 75*
- *WASHBASIN: RHO Pert® @ gold leaf finish with chrome waste. Size D 41 - H 13*

code MUSANLFORHOFO

Leonardo

MUSA FOUR silver leaf

- CONSOLLE: legno laccato nero lucido con gambe finitura foglia argento. Misure L 112 - P 58,5 - H 75
- LAVABO: FOUR in Pert® finitura foglia argento con piletta cromo. Misure L 40 - P 40 - H 14

- *CONSOLE: black gloss lacquered wood with silver leaf legs. Sizes W 112 - D 58,5 - H 75*
- *WASHBASIN: FOUR Pert® @ silver leaf finish with chrome waste. Size W 40 - D 40 - H 14*

code MUSANLFAFOUFA







DOCCIA

SHOWER TRAYS SOLUTIONS



The background of the entire image is a close-up, horizontal view of a wooden surface. The wood grain is prominent, showing various shades of brown and tan with intricate, wavy patterns and knots. The lighting is soft, highlighting the texture and natural imperfections of the wood.

L'essenza della
NATURA
del legno impreziosito

The natural essence of enriched wood

La serie Natura Lux comprende piatti doccia, top per lavabi e lastre di rivestimento per garantire la massima coordinabilità.

Realizzati in Teknoform®, il materiale delle texture a rilievo, vi doneranno la vera essenza del legno.

Il composto di resine termoindurenti, cariche di minerali naturali, è impreziosito con smalti in oro o argento e trasformano il prodotto in un vero e proprio oggetto d'arredo.

The NATURA LUX collection includes shower trays, tops and wall-covering tiles, all designed to match the full product range.

NATURA LUX is finished in our Teknoform® texture relief material, lending the collection the true essence of wood. The special composition of resins mixed with mineral fillers is enriched with precious gold and silver enamels, creating a true furnishing object.

NATURA LUX

Doccia

Shower Tray



DA VINCI
TUSCANY 212

213 DA VINCI
TUSCANY



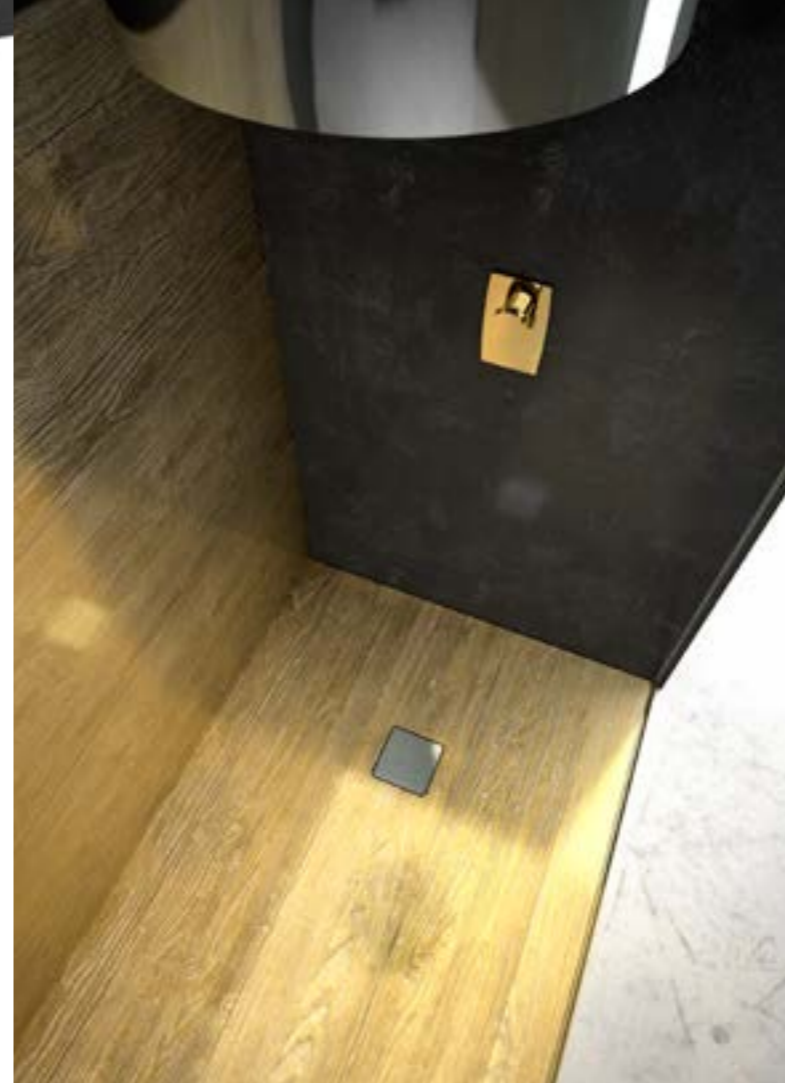

NATURA LUX GOLD

Texture legno a rilievo con smalto oro su avorio.

- **PIATTI DOCCIA**
Oltre alla loro eleganza ed originalità stilistica, i piatti doccia si distinguono per la loro flessibilità di posa e l'ampio assortimento dimensionale che va da 80 cm fino ai 200 cm. Grazie allo spessore ridotto di soli 3 cm, il piatto doccia può essere installato filo pavimento o in appoggio. Ogni piatto doccia è provvisto di griglia in acciaio inox.

- **LASTRE DI RIVESTIMENTO**
Le lastre di rivestimento sono il complemento ideale per il piatto doccia. La loro lunghezza segue quella dei piatti doccia che va da 80 cm fino a 200 cm con un'altezza di 55cm

Wood relief texture with gold enamel on ivory colour base.

- **SHOWER TRAYS**
In addition to their elegance and originality of style, the shower trays are distinguished by their flexibility of installation and dimensions ranging from 80cm to 200cm. Thanks to the reduced thickness of only 3cm, the shower tray can be installed either on top or flush with the flooring. Each shower tray is supplied with a stainless steel drain.

- **WALL COVERING TILES**
Wall covering tiles are the perfect complement to the shower tray. Their sizes follow those of the shower trays with a length ranging from 80 cm to 200 cm and a height of 55 cm.

FLESSIBILITÀ DI POSA - GREATEST FLEXIBILITY ON INSTALLATION

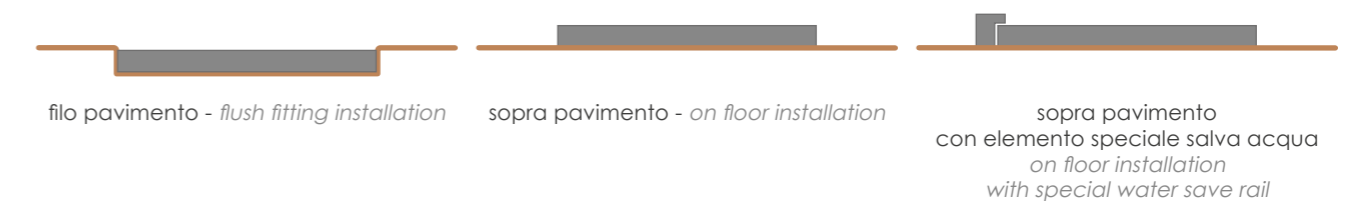

In foto/on photo
Piatto doccia Natura Lux oro/avorio. Dim. 180x90x3 cm
Shower tray Natura lux gold/ivory. Size 180x90x3 cm
code SHW90X180GD



In foto/on photo
 Top Natura lux oro/avorio. Dim. 100x50x10 cm
 Top Natura lux gold/ivory. Size 100x50x10 cm
 code: TOPW100X50GD

Lavabo Laguna Night in Vetro di Murano. Dim. Ø41cm h 17,5 cm
 Washbasin Laguna Night in Murano Glass. Size. Ø41cm h 17,5 cm
 code: LAGUNAT33



NATURA LUX GOLD

Texture legno a rilievo
 con smalto oro su avorio.

- TOP
 Il piano lavabo è realizzato in Teknoform®,
 con texture legno a rilievo.
 Disponibile in 2 misure: L 100/120 x 50 x H 10 cm.

- LAVABO LAGUNA
 Lavabo da appoggio in vetro di Murano fornito con piletta e
 anello cromati.

Wood relief texture
 with gold enamel on ivory colour base.

- TOP
 The Top is produced in Teknoform® with wood relief texture.
 Available in 2 sizes: W 100/120 x 50 x H 10 cm.

- LAGUNA WASHBASIN
 Counter top washbasin in Murano glass supplied with chrome
 waste and base ring.

FLESSIBILITÀ DI INSTALLAZIONE - GREATEST FLEXIBILITY ON INSTALLATION



NATURA LUX SILVER

Texture legno a rilievo con smalto argento su avorio.

- PIATTI DOCCIA

Oltre alla loro eleganza ed originalità stilistica, i piatti doccia si distinguono per la loro flessibilità di posa e l'ampio assortimento dimensionale che va da 80 cm fino ai 200 cm. Grazie allo spessore ridotto di soli 3 cm, il piatto doccia può essere installato filo pavimento o in appoggio. Ogni piatto doccia è provvisto di griglia in acciaio inox.

- LASTRE DI RIVESTIMENTO

Le lastre di rivestimento sono il complemento ideale per il piatto doccia. La loro lunghezza segue quella dei piatti doccia che va da 80 cm fino a 200 cm con un'altezza di 55cm.

- TOP

Il piano lavabo è realizzato in Teknoform®, con texture legno a rilievo. Disponibile in 2 misure: L 100/120 x 50 x H 10 cm.

- LAVABO LAGUNA

lavabo da appoggio in vetro di Murano fornito con piletta e anello cromati.

Wood relief texture with silver enamel on ivory colour base.

- SHOWER TRAYS

In addition to their elegance and originality of style, the shower trays are distinguished by their flexibility of installation and dimensions ranging from 80cm to 200cm. Thanks to the reduced thickness of only 3cm, the shower tray can be installed either on top or flush with the flooring. Each shower tray is supplied with a stainless steel drain.

- WALL COVERING TILES

Wall covering tiles are the perfect complement to the shower tray. Their sizes follow those of the shower trays with a length ranging from 80 cm to 200 cm and a height of 55 cm.

- TOP

The Top is produced in Teknoform®, available in two sizes: W 100/120 x 50 x H 10 cm.

- LAGUNA WASHBASIN

Counter top washbasin in Murano glass supplied with chrome waste and base ring.



FLESSIBILITÀ DI POSA - GREATEST FLEXIBILITY ON INSTALLATION

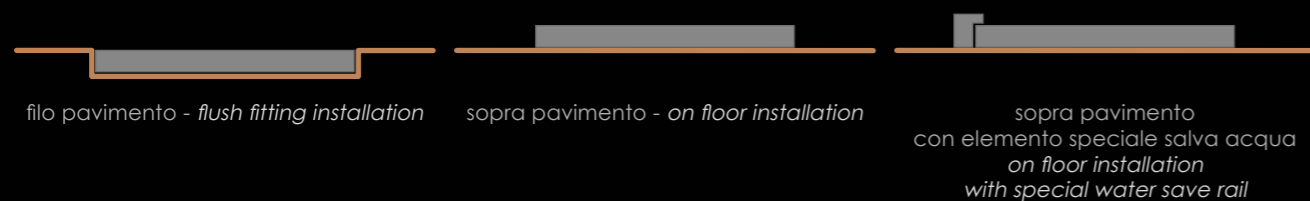

FLESSIBILITÀ DI INSTALLAZIONE - GREATEST FLEXIBILITY ON INSTALLATION



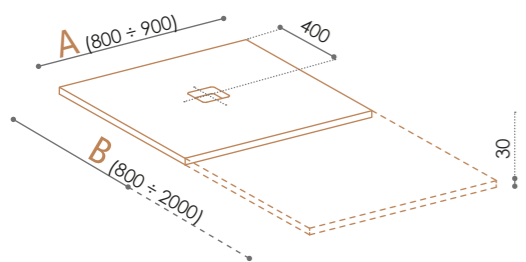

Piatti doccia Shower trays

B	A	A
	800 mm	900 mm
cm	cod.	cod.
80	SHW80X80GD	
90	SHW80X90GD	SHW90X90GD
100	SHW80X100GD	SHW90X100GD
110	SHW80X110GD	SHW90X110GD
120	SHW80X120GD	SHW90X120GD
130	SHW80X130GD	SHW90X130GD
140	SHW80X140GD	SHW90X140GD
150	SHW80X150GD	SHW90X150GD
160	SHW80X160GD	SHW90X160GD
170	SHW80X170GD	SHW90X170GD
180	SHW80X180GD	SHW90X180GD
190	SHW80X190GD	SHW90X190GD
200	SHW80X200GD	SHW90X200GD

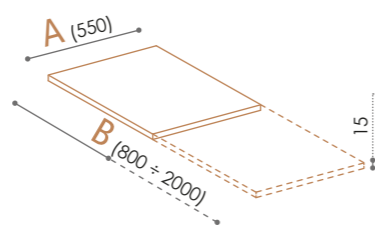

Rivestimenti Wall covering

B	A
	550 mm
cm	cod.
80	TLW55X80GD
90	TLW55X90GD
100	TLW55X100GD
110	TLW55X110GD
120	TLW55X120GD
130	TLW55X130GD
140	TLW55X140GD
150	TLW55X150GD
160	TLW55X160GD
170	TLW55X170GD
180	TLW55X180GD
190	TLW55X190GD
200	TLW55X200GD

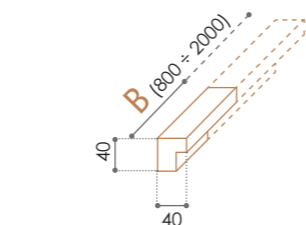

Bordo salva acqua Water save rail

Bordo salva acqua con finitura oro fornito su richiesta. Il bordo viene fornito già montato dietro disegno tecnico del cliente.
Water save rail with gold finish supplied upon request. In this case the rail will be supplied already assembled to the shower tray, behind customer technical drawing.

Sifone per piatti doccia a filo pavimento con foro scarico Ø90 mm.
Drain for shower tray with Ø 90 mm drain hole. Suitable for shower trays flush with the flooring.

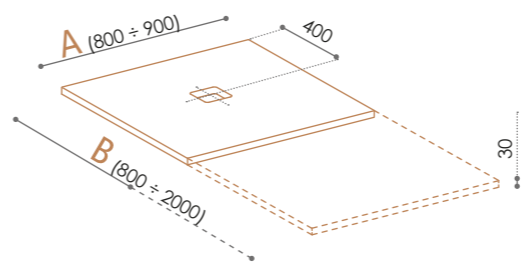
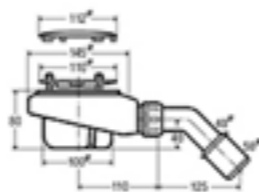

Piatti doccia Shower trays

B	A	A
	800 mm	900 mm
cm	cod.	cod.
80	SHW80X80SL	
90	SHW80X90SL	SHW90X90SL
100	SHW80X100SL	SHW90X100SL
110	SHW80X110SL	SHW90X110SL
120	SHW80X120SL	SHW90X120SL
130	SHW80X130SL	SHW90X130SL
140	SHW80X140SL	SHW90X140SL
150	SHW80X150SL	SHW90X150SL
160	SHW80X160SL	SHW90X160SL
170	SHW80X170SL	SHW90X170SL
180	SHW80X180SL	SHW90X180SL
190	SHW80X190SL	SHW90X190SL
200	SHW80X200SL	SHW90X200SL

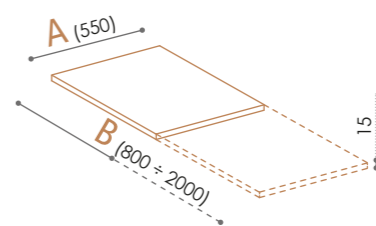

Rivestimenti Wall covering

B	A
	550 mm
cm	cod.
80	TLW55X80SL
90	TLW55X90SL
100	TLW55X100SL
110	TLW55X110SL
120	TLW55X120SL
130	TLW55X130SL
140	TLW55X140SL
150	TLW55X150SL
160	TLW55X160SL
170	TLW55X170SL
180	TLW55X180SL
190	TLW55X190SL
200	TLW55X200SL

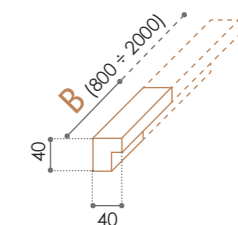

Bordo salva acqua Water save rail

Bordo salva acqua con finitura argento fornito su richiesta. Il bordo viene fornito già montato dietro disegno tecnico del cliente.
Water save rail with silver finish supplied upon request. In this case the rail will be supplied already assembled to the shower tray, behind customer technical drawing.

Sifone per piatti doccia a filo pavimento con foro scarico Ø90 mm.
Drain for shower tray with Ø 90 mm drain hole. Suitable for shower trays flush with the flooring.

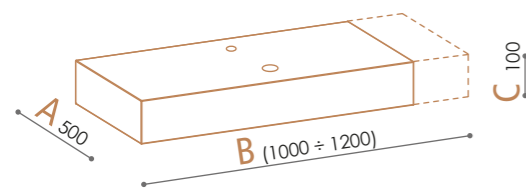
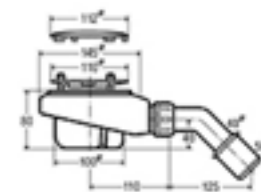

Top

B	B
1000 mm	1200 mm
cod.	cod.
TOPW100X50GD	TOPW120X50GD

Il top viene fornito con fori per lavabo e rubinetto come indicato sul disegno. Su richiesta sono realizzabili diametri e disposizioni diversi.

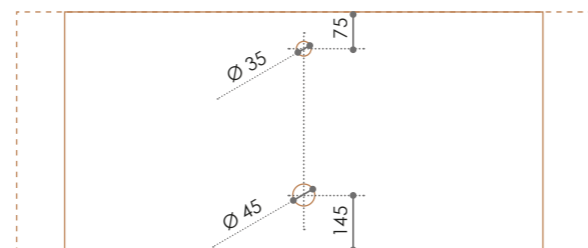

The top is supplied with pre-drilled holes as shown on the drawing. Upon request, holes can be supplied according to customer requirements.

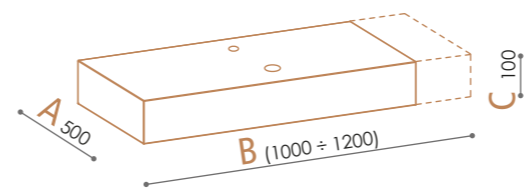

Top

B	B
1000 mm	1200 mm
cod.	cod.
TOPW100X50SL	TOPW120X50SL

Il top viene fornito con fori per lavabo e rubinetto come indicato sul disegno. Su richiesta sono realizzabili diametri e disposizioni diversi.

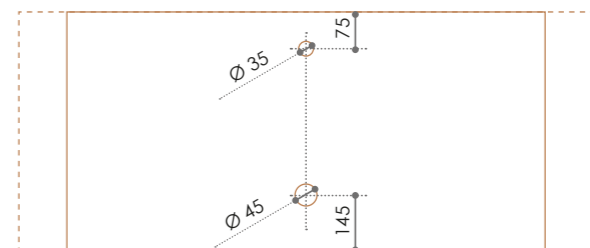

The top is supplied with pre-drilled holes as shown on the drawing. Upon request, holes can be supplied according to customer requirements.



I Top sono compatibili con tutta la gamma di lavabi Glass Design.
The tops are suitable with the full range of Glass Design washbasins.

Laguna



Ø foro / hole = 45 mm
peso / weight = 4,70 kg

Base anello cromata e piletta inclusi
Chrome plug and chrome ring basement included

code:



night
LAGUNAT33



smoke
LAGUNAT43



red
LAGUNAT16



blue
LAGUNAT42

Il fascino di una
TERRA
pregiata

The fascination of precious ground

La serie TERRA LUX comprende piatti doccia, top per lavabi e lastre di rivestimento per garantire la massima coordinabilità.

Realizzati in Teknoform®, il materiale delle texture a rilievo, vi doneranno la vera essenza della pietra.

Il composto di resine termoindurenti, cariche di minerali naturali, è impreziosito con smalti in oro o argento e trasformano il prodotto in un vero e proprio oggetto d'arredo.

The TERRA LUX collection includes shower trays, tops and wall-covering files, all designed to match the full product range.

TERRA LUX is finished in our Teknoform® texture relief material, lending the collection the true essence of stone. The special composition of resins mixed with mineral fillers is enriched with precious gold and silver enamels, creating a true furnishing object.

TERRA LUX

Doccia

Shower Tray

225 DA VINCI
TUSCANY



DA VINCI 224
TUSCANY

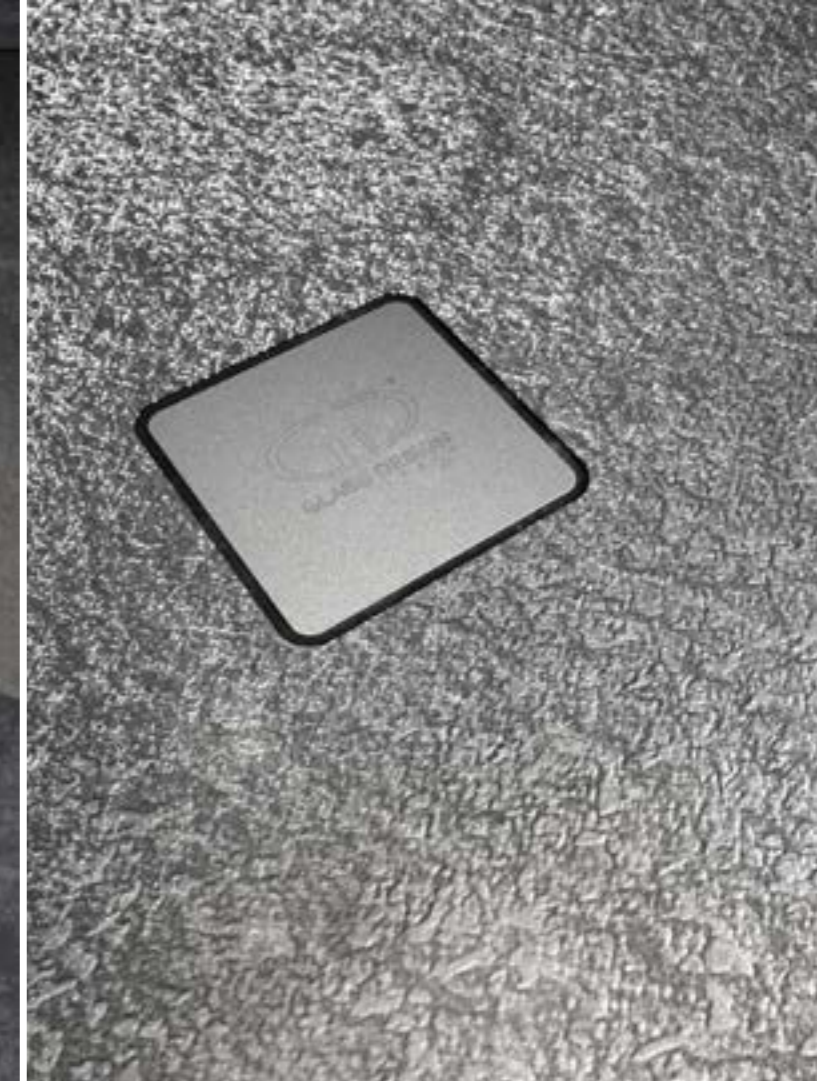
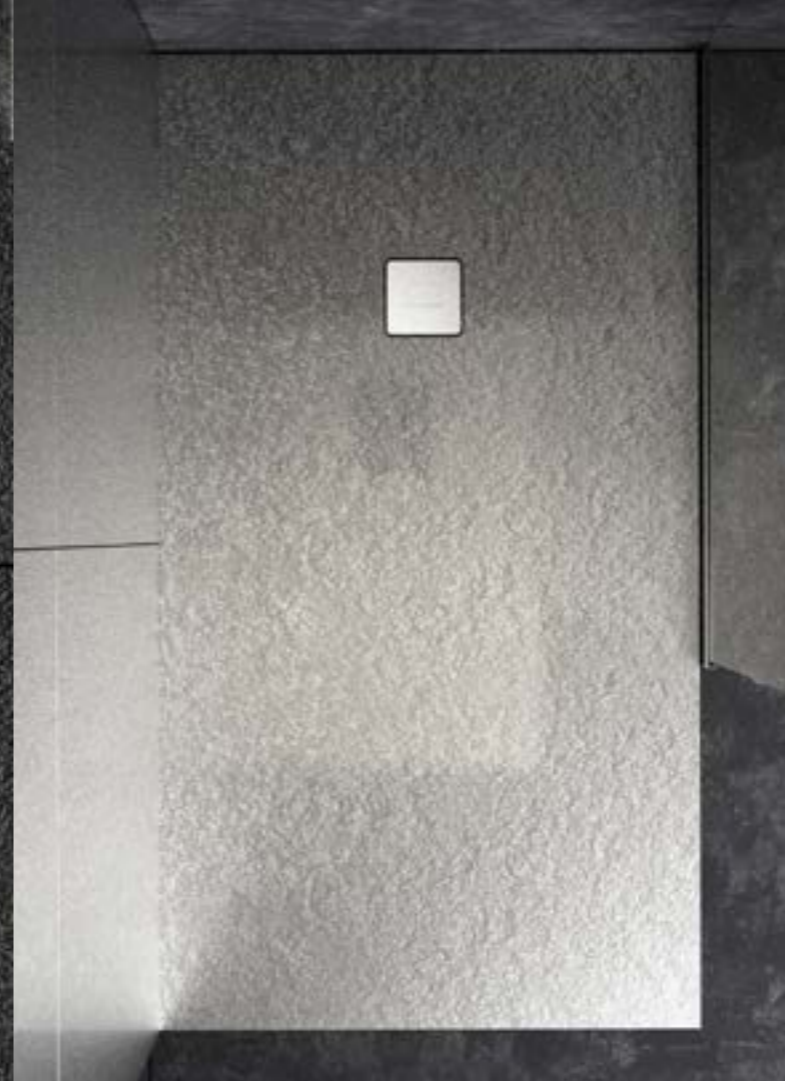

TERRA LUX SILVER

Texture pietra a rilievo
con smalto argento su avorio

- **PIATTI DOCCIA**
Oltre alla loro eleganza ed originalità stilistica, i piatti doccia si distinguono per la loro flessibilità di posa e l'ampio assortimento dimensionale che va da 80 cm fino ai 200 cm. Grazie allo spessore ridotto di soli 3 cm, il piatto doccia può essere installato filo pavimento o in appoggio. Ogni piatto doccia è provvisto di griglia in acciaio inox.

- **LASTRE DI RIVESTIMENTO**
Le lastre di rivestimento sono il complemento ideale per il piatto doccia. La loro lunghezza segue quella dei piatti doccia che va da 80 cm fino a 200 cm con un'altezza di 55cm.

Stone relief texture with silver enamel
on ivory colour base.

- **SHOWER TRAYS**
In addition to their elegance and originality of style, the shower trays are distinguished by their flexibility of installation and dimensions ranging from 80cm to 200cm. Thanks to the reduced thickness of only 3cm, the shower tray can be installed either on top or flush with the flooring. Each shower tray is supplied with a stainless steel drain.

- **WALL COVERING TILES**
Wall covering tiles are the perfect complement to the shower tray. Their sizes follow those of the shower trays with a length ranging from 80 cm to 200 cm and a height of 55 cm.

FLESSIBILITÀ DI POSA - GREATEST FLEXIBILITY ON INSTALLATION

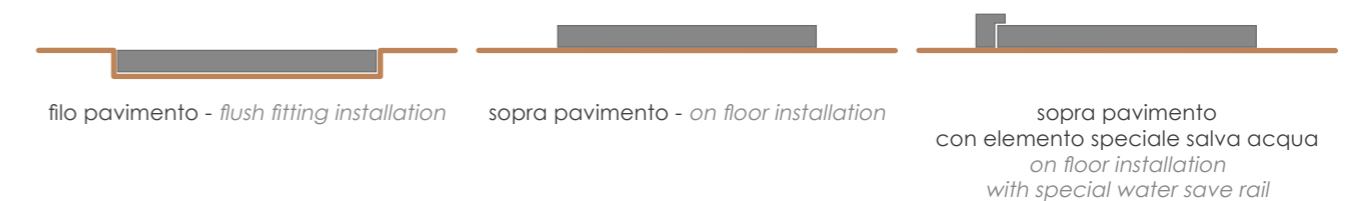

In foto/on photo
Lastre di rivestimento in Terra lux argento/avorio. Dim. 80x55 cm
Wall covering tiles Terra lux silver/ivory. Size 80x55 cm
code TLS55X80SL



TERRA LUX SILVER

Texture pietra a rilievo
con smalto argento su avorio

- TOP
Il piano lavabo è realizzato in Teknoform®, con texture pietra a rilievo. Disponibile in 2 misure: L 100/120 x 50 x H 10 cm.

- LAVABO LAGUNA
Lavabo da appoggio in vetro di Murano fornito con piletta e anello cromati.

Stone relief texture with silver enamel
on ivory colour base.

- TOP
The Top is produced in Teknoform® with stone relief texture. Available in 2 sizes: W100/120 x 50 x H 10 cm.

- LAGUNA WASHBASIN
Counter top washbasin in Murano glass supplied with chrome waste and base ring.

FLESSIBILITÀ DI INSTALLAZIONE - GREATEST FLEXIBILITY ON INSTALLATION



In foto/on photo
Top Terra Lux argento/avorio. Dim. 100x50x10 cm
Top Terra lux silver/ivory. Size 100x50x10 cm
code TOPS100X50SL

Lavabo Laguna Blue in Vetro di Murano Dim. Ø41cm h 17,5 cm
Washbasin Laguna Blue Murano Glass. Size. Ø41cm h 17,5 cm
code: LAGUNAT42

TERRA LUX GOLD

Texture pietra a rilievo con smalto oro su avorio.

- PIATTI DOCCIA

Oltre alla loro eleganza ed originalità stilistica, i piatti doccia si distinguono per la loro flessibilità di posa e l'ampio assortimento dimensionale che va da 80 cm fino ai 200 cm. Grazie allo spessore ridotto di soli 3 cm, il piatto doccia può essere installato filo pavimento o in appoggio. Ogni piatto doccia è provvisto di griglia in acciaio inox.

- LASTRE DI RIVESTIMENTO

Le lastre di rivestimento sono il complemento ideale per il piatto doccia. La loro lunghezza segue quella dei piatti doccia che va da 80 cm fino a 200 cm con un'altezza di 55cm.

- TOP

Il piano lavabo è realizzato in Teknoform®, con texture pietra a rilievo. Disponibile in 2 misure: L100/120 x 50 x H 10 cm.

- LAVABO LAGUNA

lavabo da appoggio in vetro di Murano fornito con piletta e anello cromati.

Stone relief texture with gold enamel on ivory colour base.

- SHOWER TRAYS

In addition to their elegance and originality of style, the shower trays are distinguished by their flexibility of installation and dimensions ranging from 80cm to 200cm. Thanks to the reduced thickness of only 3cm, the shower tray can be installed either on top or flush with the flooring. Each shower tray is supplied with a stainless steel drain.

- WALL COVERING TILES

Wall covering tiles are the perfect complement to the shower tray. Their sizes follow those of the shower trays with a length ranging from 80 cm to 200 cm and a height of 55 cm.

- TOP

The Top is produced in Teknoform®, with stone relief texture. Available in two sizes: W 100/120 x 50 x H 10 cm.

- LAGUNA WASHBASIN

Counter top washbasin in Murano glass supplied with chrome waste and base ring.

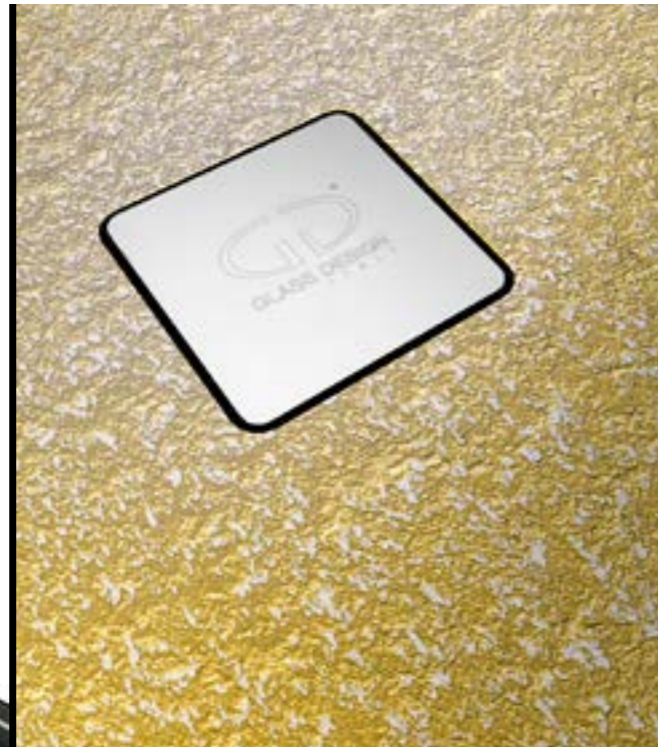

FLESSIBILITÀ DI POSA - GREATEST FLEXIBILITY ON INSTALLATION

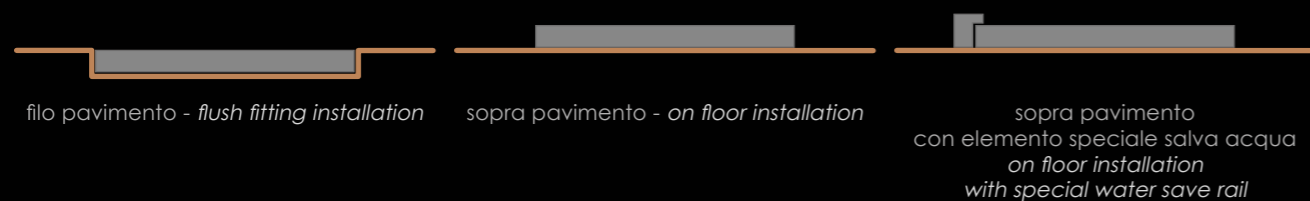

FLESSIBILITÀ DI INSTALLAZIONE - GREATEST FLEXIBILITY ON INSTALLATION



TERRA LUX



GOLD



SILVER

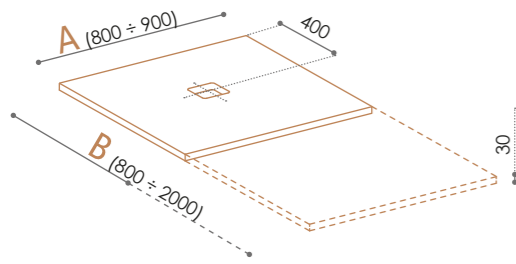

Piatti doccia Shower trays

B	A	A
	800 mm	900 mm
cm	cod.	cod.
80	SHS80X80GD	
90	SHS80X90GD	SHS90X90GD
100	SHS80X100GD	SHS90X100GD
110	SHS80X110GD	SHS90X110GD
120	SHS80X120GD	SHS90X120GD
130	SHS80X130GD	SHS90X130GD
140	SHS80X140GD	SHS90X140GD
150	SHS80X150GD	SHS90X150GD
160	SHS80X160GD	SHS90X160GD
170	SHS80X170GD	SHS90X170GD
180	SHS80X180GD	SHS90X180GD
190	SHS80X190GD	SHS90X190GD
200	SHS80X200GD	SHS90X200GD

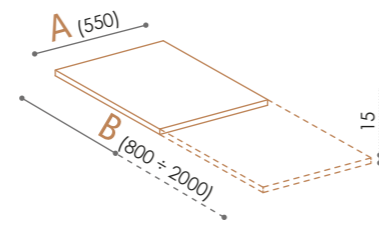

Rivestimenti Wall covering

B	A
	550 mm
cm	cod.
80	TLS55X80GD
90	TLS55X90GD
100	TLS55X100GD
110	TLS55X110GD
120	TLS55X120GD
130	TLS55X130GD
140	TLS55X140GD
150	TLS55X150GD
160	TLS55X160GD
170	TLS55X170GD
180	TLS55X180GD
190	TLS55X190GD
200	TLS55X200GD

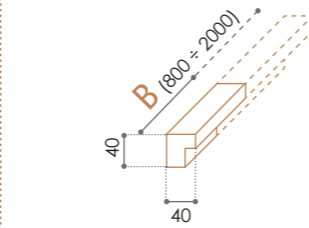

Bordo salva acqua Water save rail

Bordo salva acqua con finitura oro fornito su richiesta. Il bordo viene fornito già montato dietro disegno tecnico del cliente.
Water save rail with gold finish supplied upon request. In this case the rail will be supplied already assembled to the shower tray, behind customer technical drawing.

Sifone per piatti doccia a filo pavimento con foro scarico Ø90 mm.
Drain for shower tray with Ø 90 mm drain hole. Suitable for shower trays flush with the flooring.

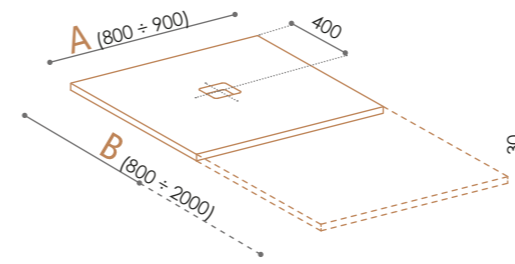
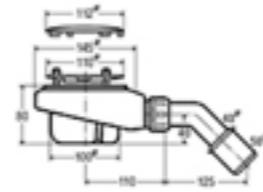

Piatti doccia Shower trays

B	A	A
	800 mm	900 mm
cm	cod.	cod.
80	SHS80X80SL	
90	SHS80X90SL	SHS90X90SL
100	SHS80X100SL	SHS90X100SL
110	SHS80X110SL	SHS90X110SL
120	SHS80X120SL	SHS90X120SL
130	SHS80X130SL	SHS90X130SL
140	SHS80X140SL	SHS90X140SL
150	SHS80X150SL	SHS90X150SL
160	SHS80X160SL	SHS90X160SL
170	SHS80X170SL	SHS90X170SL
180	SHS80X180SL	SHS90X180SL
190	SHS80X190SL	SHS90X190SL
200	SHS80X200SL	SHS90X200SL

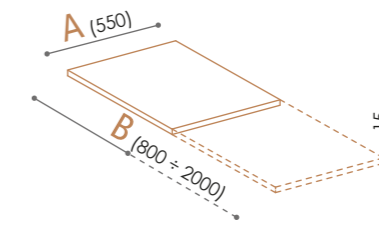

Rivestimenti Wall covering

B	A
	550 mm
cm	cod.
80	TLS55X80SL
90	TLS55X90SL
100	TLS55X100SL
110	TLS55X110SL
120	TLS55X120SL
130	TLS55X130SL
140	TLS55X140SL
150	TLS55X150SL
160	TLS55X160SL
170	TLS55X170SL
180	TLS55X180SL
190	TLS55X190SL
200	TLS55X200SL

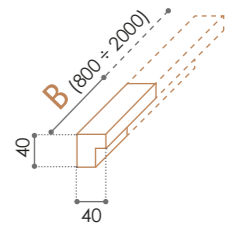

Bordo salva acqua Water save rail

Bordo salva acqua con finitura argento fornito su richiesta. Il bordo viene fornito già montato dietro disegno tecnico del cliente.
Water save rail with silver finish supplied upon request. In this case the rail will be supplied already assembled to the shower tray, behind customer technical drawing.

Sifone per piatti doccia a filo pavimento con foro scarico Ø90 mm.
Drain for shower tray with Ø 90 mm drain hole. Suitable for shower trays flush with the flooring.

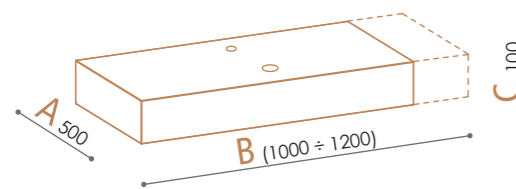
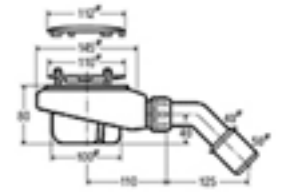

Top

B	B
1000 mm	1200 mm
cod.	cod.
TOPS100X50GD	TOPS120X50GD

Il top viene fornito con fori per lavabo e rubinetto come indicato sul disegno. Su richiesta sono realizzabili diametri e disposizioni diversi.

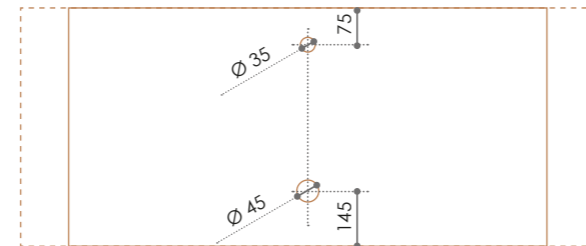

The top is supplied with pre-drilled holes as shown on the drawing. Upon request, holes can be supplied according to customer requirements.

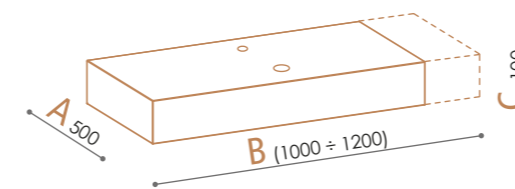

Top

B	B
1000 mm	1200 mm
cod.	cod.
TOPS100X50SL	TOPS120X50SL

Il top viene fornito con fori per lavabo e rubinetto come indicato sul disegno. Su richiesta sono realizzabili diametri e disposizioni diversi.

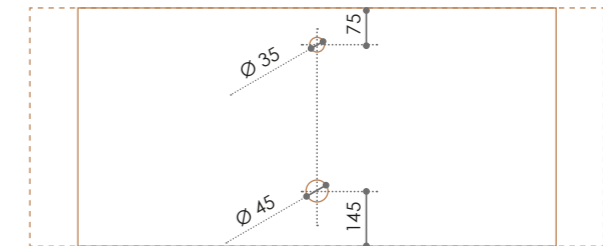

The top is supplied with pre-drilled holes as shown on the drawing. Upon request, holes can be supplied according to customer requirements.



I Top sono compatibili con tutta la gamma di lavabi Glass Design.
The tops are suitable with the full range of Glass Design washbasins.

Laguna



Ø foro / hole = 45 mm
peso / weight = 4,70 kg

Base anello cromata e piletta inclusi
Chrome plug and chrome ring basement included

code:



night
LAGUNAT33



smoke
LAGUNAT43



red
LAGUNAT16



blue
LAGUNAT42

The background of the entire image is a dark, rich brown wood grain. The grain pattern is wavy and organic, with various knots and swirls visible. The lighting is subtle, highlighting the texture of the wood.

L'essenza
NATURALE
del legno

The natural essence of wood



La serie Natura comprende piatti doccia, top per lavabi e lastre di rivestimento per garantire la massima coordinabilità. Realizzati in Teknoform®, il materiale delle texture a rilievo, vi doneranno la vera essenza del legno. Il composto di resine termoindurenti, cariche di minerali naturali, trasformano il prodotto in un vero e proprio oggetto d'arredo.

The NATURA collection includes shower trays, tops and wall-covering tiles, all designed to match the full product range. NATURA is finished in our Teknoform® texture relief material, lending the collection the true essence of wood. The special composition of resins mixed with mineral fillers lets the product become a true furnishing object.

NATURA

Doccia

Shower Tray



In foto/on photo
 Piatto doccia Natura wengé . Dim. 180x90x3 cm
 Shower tray Natura wengé . Size 180x90x3 cm
 code SHW90X180WG



NATURA WENGÉ

Texture legno a rilievo
 finitura wengé.

- **PIATTI DOCCIA**
 Oltre alla loro eleganza ed originalità stilistica, i piatti doccia si distinguono per la loro flessibilità di posa e l'ampio assortimento dimensionale che va da 80 cm fino ai 200 cm. Grazie allo spessore ridotto di soli 3 cm, il piatto doccia può essere installato filo pavimento o in appoggio. Ogni piatto doccia è provvisto di griglia in acciaio inox.

- **LASTRE DI RIVESTIMENTO**
 Le lastre di rivestimento sono il complemento ideale per il piatto doccia. La loro lunghezza segue quella dei piatti doccia che va da 80 cm fino a 200 cm con un'altezza di 55 cm.

Wood relief texture wengé finish

- **SHOWER TRAYS**
 In addition to their elegance and originality of style, the shower trays are distinguished by their flexibility of installation and dimensions ranging from 80cm to 200cm. Thanks to the reduced thickness of only 3cm, the shower tray can be installed either on top or flush with the flooring. Each shower tray is supplied with a stainless steel drain.

- **WALL COVERING TILES**
 Wall covering tiles are the perfect complement to the shower tray. Their sizes follow those of the shower trays with a length ranging from 80 cm to 200 cm and a height of 55 cm.

FLESSIBILITÀ DI POSA - GREATEST FLEXIBILITY ON INSTALLATION

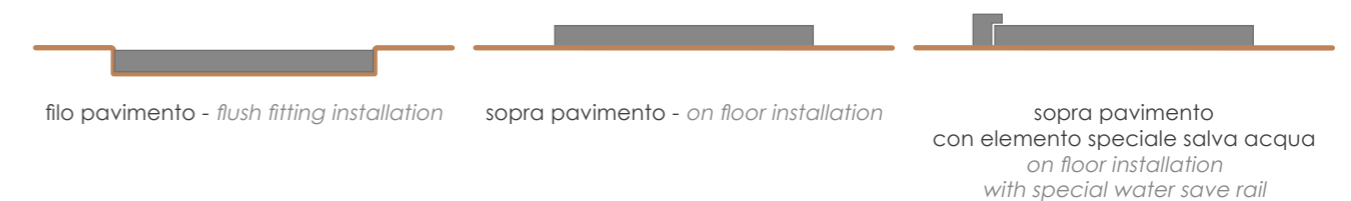



In foto/on photo
Top Natura wengé. Dim. 120x50x10 cm
Top Natura wengé. Size 120x50x10 cm
code: TOPW120X50WG

Lavabo Laguna Smoke in Vetro di Murano' Dim. Ø41cm h 17,5 cm
Washbasin Laguna Smoke Murano Glass. Size. Ø41cm h 17,5 cm
code: LAGUNAT43



NATURA WENGÉ

Texture legno a rilievo
finitura wengé.

- TOP
Il piano lavabo è realizzato in Teknoform®,
con texture legno a rilievo.
Disponibile in 2 misure: L 100/120 x 50 x H 10 cm.

- LAVABO LAGUNA
Lavabo da appoggio in vetro di Murano fornito con piletta e
anello cromati.

Wood relief texture wengé finish

- TOP
The Top is produced in Teknoform® with wood relief texture.
Available in 2 sizes: W 100/120 x 50 x H 10 cm.

- LAGUNA WASHBASIN
Counter top washbasin in Murano glass supplied with chrome
waste and base ring.

FLESSIBILITÀ DI INSTALLAZIONE - GREATEST FLEXIBILITY ON INSTALLATION



NATURA ROVERE

Texture legno a rilievo finitura rovere.

- PIATTI DOCCIA

Oltre alla loro eleganza ed originalità stilistica, i piatti doccia si distinguono per la loro flessibilità di posa e l'ampio assortimento dimensionale che va da 80 cm fino ai 200 cm. Grazie allo spessore ridotto di soli 3 cm, il piatto doccia può essere installato filo pavimento o in appoggio. Ogni piatto doccia è provvisto di griglia in acciaio inox.

- LASTRE DI RIVESTIMENTO

Le lastre di rivestimento sono il complemento ideale per il piatto doccia. La loro lunghezza segue quella dei piatti doccia che va da 80 cm fino a 200 cm con un'altezza di 55cm.

- TOP

Il piano lavabo è realizzato in Teknoform®, con texture legno a rilievo. Disponibile in 2 misure: L 100/120 x 50 x H 10 cm.

- LAVABO LAGUNA

lavabo da appoggio in vetro di Murano fornito con piletta e anello cromati.

Wood relief texture oak finish

- SHOWER TRAYS

In addition to their elegance and originality of style, the shower trays are distinguished by their flexibility of installation and dimensions ranging from 80cm to 200cm. Thanks to the reduced thickness of only 3cm, the shower tray can be installed either on top or flush with the flooring. Each shower tray is supplied with a stainless steel drain.

- WALL COVERING TILES

Wall covering tiles are the perfect complement to the shower tray. Their sizes follow those of the shower trays with a length ranging from 80 cm to 200 cm and a height of 55 cm.

- TOP

The Top is produced in Teknoform®, with wood relief texture. Available in two sizes: W 100/120 x 50 x H 10 cm.

- LAGUNA WASHBASIN

Counter top washbasin in Murano glass supplied with chrome waste and base ring.



FLESSIBILITÀ DI POSA - GREATEST FLEXIBILITY ON INSTALLATION

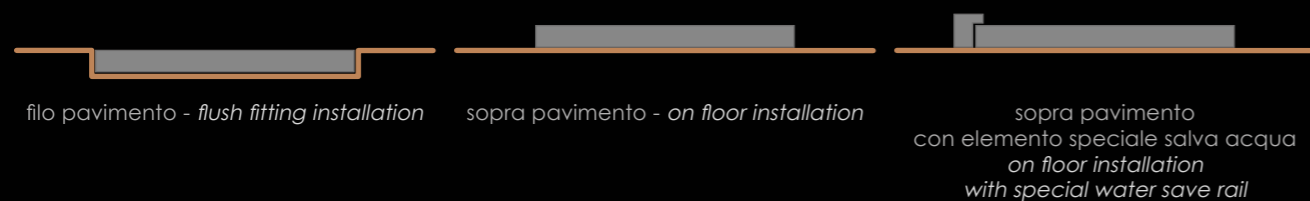

FLESSIBILITÀ DI INSTALLAZIONE - GREATEST FLEXIBILITY ON INSTALLATION



NATURA



WENGÉ



ROVERE

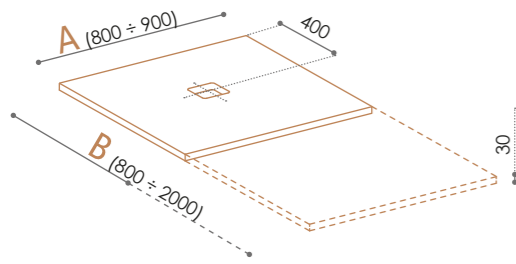

Piatti doccia
Shower trays

B	A	A
	800 mm	900 mm
cm	cod.	cod.
80	SHW80X80WG	
90	SHW80X90WG	SHW90X90WG
100	SHW80X100WG	SHW90X100WG
110	SHW80X110WG	SHW90X110WG
120	SHW80X120WG	SHW90X120WG
130	SHW80X130WG	SHW90X130WG
140	SHW80X140WG	SHW90X140WG
150	SHW80X150WG	SHW90X150WG
160	SHW80X160WG	SHW90X160WG
170	SHW80X170WG	SHW90X170WG
180	SHW80X180WG	SHW90X180WG
190	SHW80X190WG	SHW90X190WG
200	SHW80X200WG	SHW90X200WG

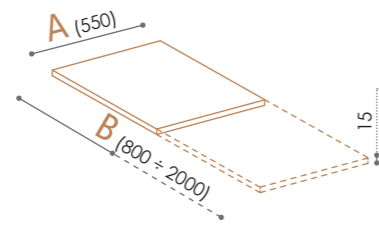

Rivestimenti
Wall covering

B	A
	550 mm
cm	cod.
80	TLW55X80WG
90	TLW55X90WG
100	TLW55X100WG
110	TLW55X110WG
120	TLW55X120WG
130	TLW55X130WG
140	TLW55X140WG
150	TLW55X150WG
160	TLW55X160WG
170	TLW55X170WG
180	TLW55X180WG
190	TLW55X190WG
200	TLW55X200WG

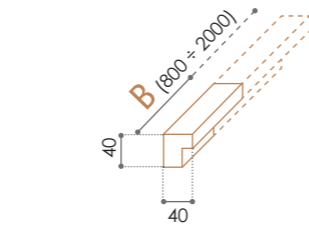

Bordo salva acqua
Water save rail

Bordo salva acqua con finitura wengé fornito su richiesta. Il bordo viene fornito già montato dietro disegno tecnico del cliente.
Water save rail with wengé finish supplied upon request. In this case the rail will be supplied already assembled to the shower tray, behind customer technical drawing.

Sifone per piatti doccia a filo pavimento con foro scarico Ø90 mm.
Drain for shower tray with Ø 90 mm drain hole. Suitable for shower trays flush with the flooring.

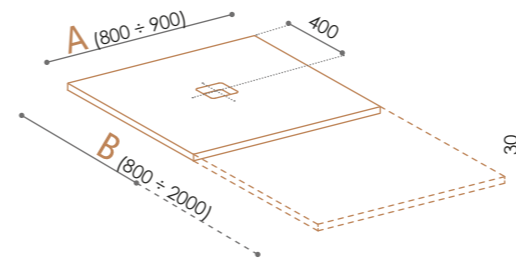
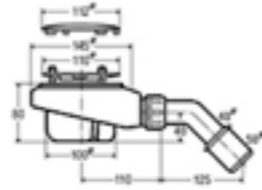

Piatti doccia
Shower trays

B	A	A
	800 mm	900 mm
cm	cod.	cod.
80	SHW80X80RV	
90	SHW80X90RV	SHW90X90RV
100	SHW80X100RV	SHW90X100RV
110	SHW80X110RV	SHW90X110RV
120	SHW80X120RV	SHW90X120RV
130	SHW80X130RV	SHW90X130RV
140	SHW80X140RV	SHW90X140RV
150	SHW80X150RV	SHW90X150RV
160	SHW80X160RV	SHW90X160RV
170	SHW80X170RV	SHW90X170RV
180	SHW80X180RV	SHW90X180RV
190	SHW80X190RV	SHW90X190RV
200	SHW80X200RV	SHW90X200RV

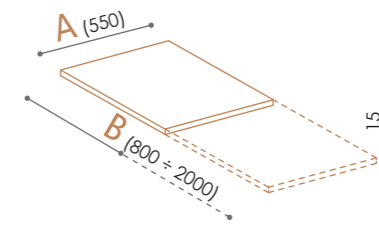

Rivestimenti
Wall covering

B	A
	550 mm
cm	cod.
80	TLW55X80RV
90	TLW55X90RV
100	TLW55X100RV
110	TLW55X110RV
120	TLW55X120RV
130	TLW55X130RV
140	TLW55X140RV
150	TLW55X150RV
160	TLW55X160RV
170	TLW55X170RV
180	TLW55X180RV
190	TLW55X190RV
200	TLW55X200RV

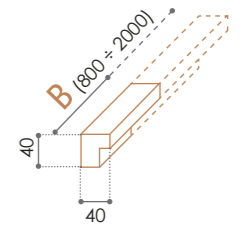

Bordo salva acqua
Water save rail

Bordo salva acqua con finitura rovere fornito su richiesta. Il bordo viene fornito già montato dietro disegno tecnico del cliente.
Water save rail with oak finish supplied upon request. In this case the rail will be supplied already assembled to the shower tray, behind customer technical drawing.

Sifone per piatti doccia a filo pavimento con foro scarico Ø90 mm.
Drain for shower tray with Ø 90 mm drain hole. Suitable for shower trays flush with the flooring.

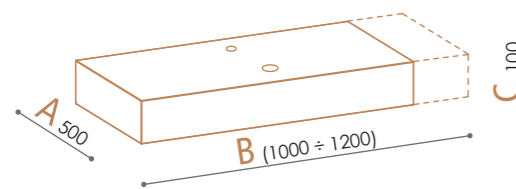
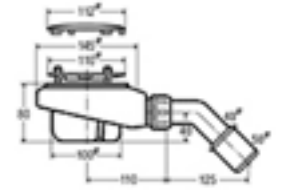

Top

B	B
1000 mm	1200 mm
cod.	cod.
TOPW100X50WG	TOPW120X50WG

Il top viene fornito con fori per lavabo e rubinetto come indicato sul disegno. Su richiesta sono realizzabili diametri e disposizioni diversi.

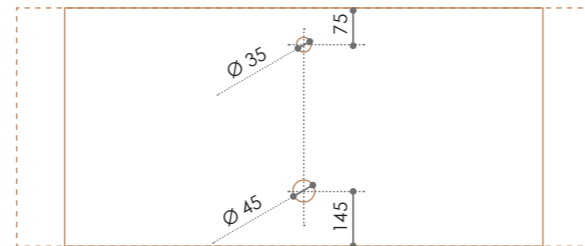

The top is supplied with pre-drilled holes as shown on the drawing. Upon request, holes can be supplied according to customer requirements.

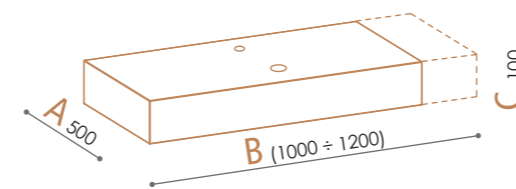

Top

B	B
1000 mm	1200 mm
cod.	cod.
TOPW100X50RV	TOPW120X50RV

Il top viene fornito con fori per lavabo e rubinetto come indicato sul disegno. Su richiesta sono realizzabili diametri e disposizioni diversi.

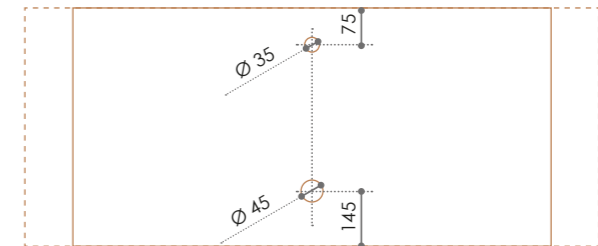

The top is supplied with pre-drilled holes as shown on the drawing. Upon request, holes can be supplied according to customer requirements.



I Top sono compatibili con tutta la gamma di lavabi Glass Design.
The tops are suitable with the full range of Glass Design washbasins.

Laguna



Ø foro / hole = 45 mm
peso / weight = 4,70 kg

Base anello cromata e piletta inclusi
Chrome plug and chrome ring basement included

code:



night
LAGUNAT33



smoke
LAGUNAT43



red
LAGUNAT16



blue
LAGUNAT42

La piacevole
sensazione della
TERRA

Sensational feelings with the ground



La serie Terra comprende piatti doccia, top per lavabi e lastre di rivestimento per garantire la massima coordinabilità. Realizzati in Teknoform®, il materiale delle texture a rilievo, vi doneranno la vera essenza della pietra.

Il composto di resine termoindurenti, cariche di minerali naturali, trasformano il prodotto in un vero e proprio oggetto d'arredo.

The TERRA collection includes shower trays, tops and wall-covering tiles, all designed to match the full product range.

TERRA is finished in our Teknoform® texture relief material, lending the collection the true essence of stone. The special composition of resins mixed with mineral fillers lets the product become a true furnishing object.



TERRA



TERRA BIANCO

Texture pietra a rilievo finitura bianco.

Stone relief texture white finish.

- **PIATTI DOCCIA**
Oltre alla loro eleganza ed originalità stilistica, i piatti doccia si distinguono per la loro flessibilità di posa e l'ampio assortimento dimensionale che va da 80 cm fino ai 200 cm. Grazie allo spessore ridotto di soli 3 cm, il piatto doccia può essere installato filo pavimento o in appoggio. Ogni piatto doccia è provvisto di griglia in acciaio inox.

- **SHOWER TRAYS**
In addition to their elegance and originality of style, the shower trays are distinguished by their flexibility of installation and dimensions ranging from 80cm to 200cm. Thanks to the reduced thickness of only 3cm, the shower tray can be installed either on top or flush with the flooring. Each shower tray is supplied with a stainless steel drain.

- **LASTRE DI RIVESTIMENTO**
Le lastre di rivestimento sono il complemento ideale per il piatto doccia. La loro lunghezza segue quella dei piatti doccia che va da 80 cm fino a 200 cm con un'altezza di 55 cm.

- **WALL COVERING TILES**
Wall covering tiles are the perfect complement to the shower tray. Their sizes follow those of the shower trays with a length ranging from 80 cm to 200 cm and a height of 55 cm.

FLESSIBILITÀ DI POSA - GREATEST FLEXIBILITY ON INSTALLATION

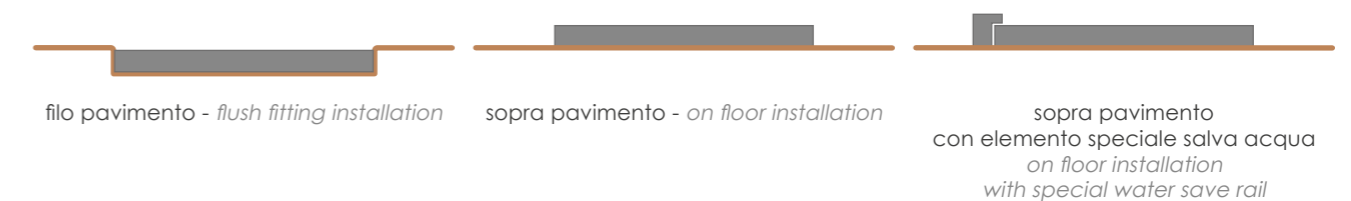

In foto/on photo
Piatto doccia Terra bianco. Dim. 200x90x3 cm Shower tray Terra white. Size 200x90x3 cm. code: SHS90X200PO01
Lastre di rivestimento Terra bianco 90x55 cm Wall covering tiles Terra white 90x55 cm. code: TLS55X90PO01



In foto/on photo
 Top Terra bianco. Dim. 120x50x10 cm
 Top Terra white. Size 120x50x10 cm
 Code TOPS120X50P001

Lavabo Laguna Night in Vetro di Murano. Dim. Ø41cm h 17,5 cm
 Washbasin Laguna Night Murano Glass. Size. Ø41cm h 17,5 cm
 code: LAGUNAT33

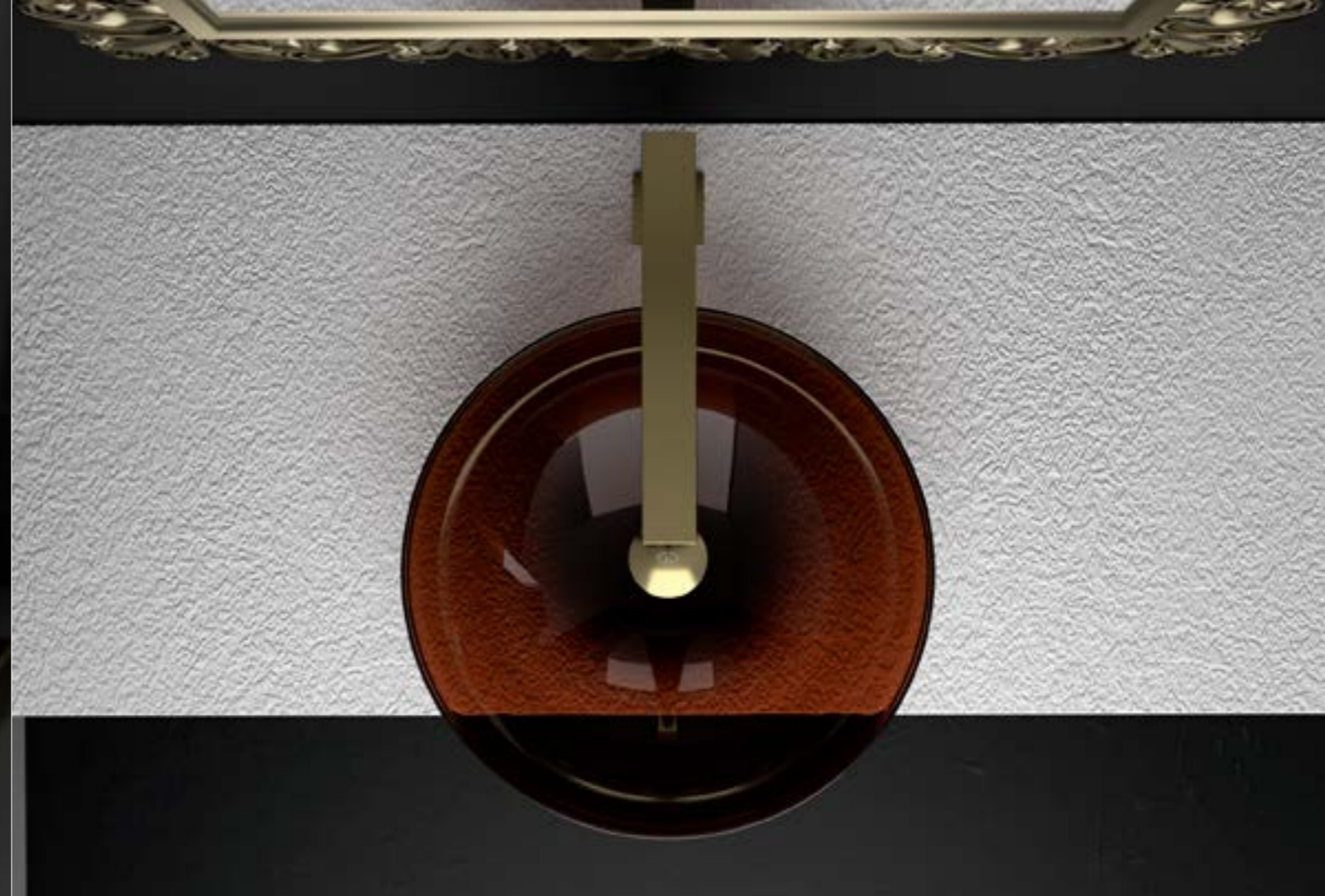

TERRA BIANCO

Texture pietra a rilievo finitura bianco.

- TOP
 Il piano lavabo è realizzato in Teknoform®, con texture pietra a rilievo.
 Disponibile in 2 misure: L 100/120 x 50 x H 10 cm.

- LAVABO LAGUNA
 Lavabo da appoggio in vetro di Murano fornito con piletta e anello cromati.

Stone relief texture white finish.

- TOP
 The Top is produced in Teknoform® with stone relief texture.
 Available in 2 sizes: W 100/120 x 50 x H 10 cm.

- LAGUNA WASHBASIN
 Counter top washbasin in Murano glass supplied with chrome waste and base ring.

FLESSIBILITÀ DI INSTALLAZIONE - GREATEST FLEXIBILITY ON INSTALLATION



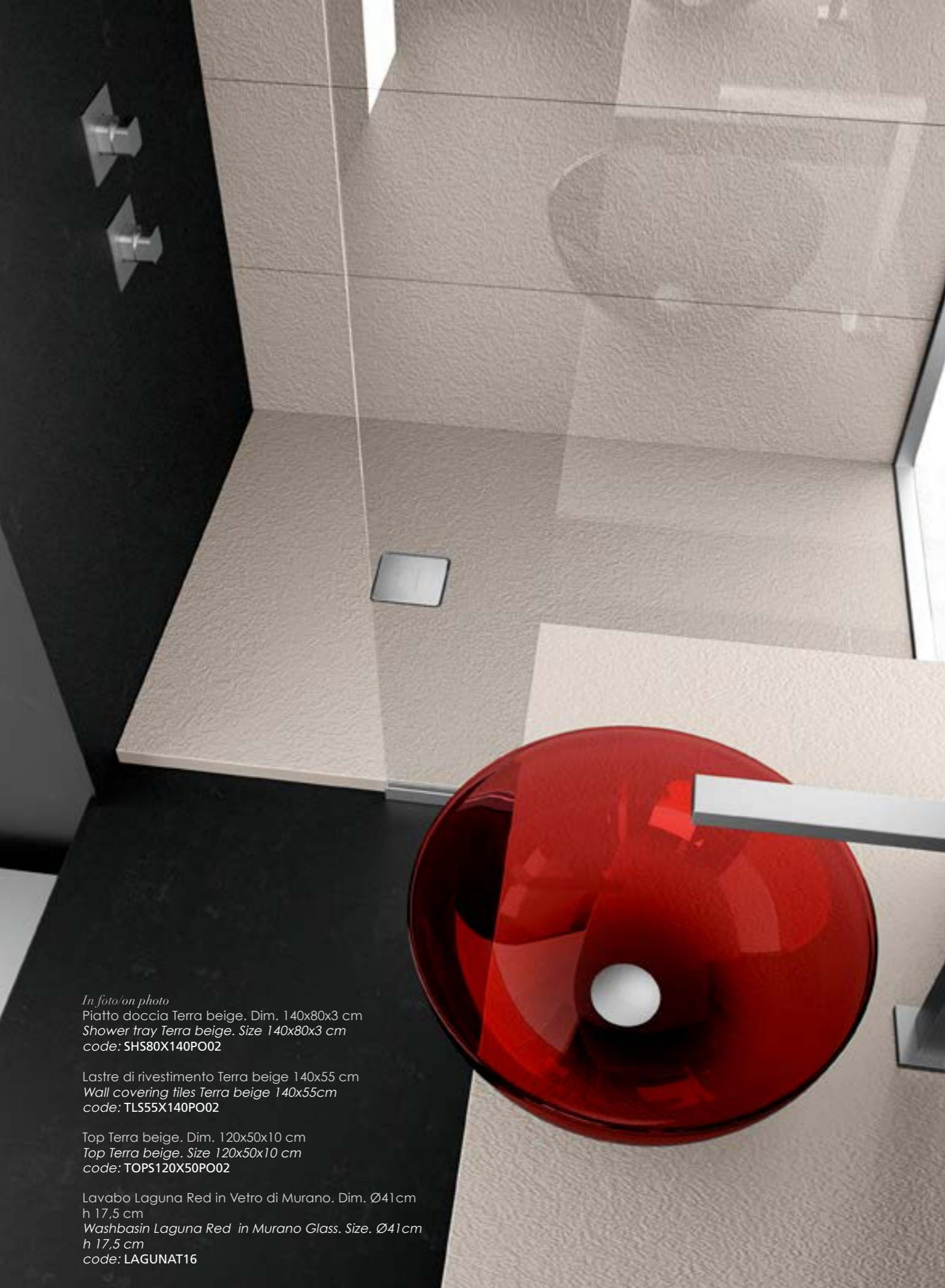

In foto/on photo

Piatto doccia Terra beige. Dim. 140x80x3 cm
Shower tray Terra beige. Size 140x80x3 cm
code: SHS80X140PO02

Lastre di rivestimento Terra beige 140x55 cm
Wall covering tiles Terra beige 140x55cm
code: TLS55X140PO02

Top Terra beige. Dim. 120x50x10 cm
Top Terra beige. Size 120x50x10 cm
code: TOPS120X50PO02

Lavabo Laguna Red in Vetro di Murano. Dim. Ø41cm
h 17,5 cm
Washbasin Laguna Red in Murano Glass. Size. Ø41cm
h 17,5 cm
code: LAGUNAT16



TERRA BEIGE

Texture pietra a rilievo finitura beige.

- **PIATTI DOCCIA**
Oltre alla loro eleganza ed originalità stilistica, i piatti doccia si distinguono per la loro flessibilità di posa e l'ampio assortimento dimensionale che va da 80 cm fino ai 200 cm. Grazie allo spessore ridotto di soli 3 cm, il piatto doccia può essere installato filo pavimento o in appoggio. Ogni piatto doccia è provvisto di griglia in acciaio inox.

- **LASTRE DI RIVESTIMENTO**
Le lastre di rivestimento sono il complemento ideale per il piatto doccia. La loro lunghezza segue quella dei piatti doccia che va da 80 cm fino a 200 cm con un'altezza di 55cm.

- **TOP**
Il piano lavabo è realizzato in Teknoform®, con texture pietra a rilievo. Disponibile in 2 misure: L 100/120 x 50 x H 10 cm.

- **LAVABO LAGUNA**
Lavabo da appoggio in vetro di Murano fornito con piletta e anello cromati.

Stone relief texture beige finish.

- **SHOWER TRAYS**
In addition to their elegance and originality of style, the shower trays are distinguished by their flexibility of installation and dimensions ranging from 80cm to 200cm. Thanks to the reduced thickness of only 3cm, the shower tray can be installed either on top or flush with the flooring. Each shower tray is supplied with a stainless steel drain.

- **WALL COVERING TILES**
Wall covering tiles are the perfect complement to the shower tray. Their sizes follow those of the shower trays with a length ranging from 80 cm to 200 cm and a height of 55 cm.

- **TOP**
The Top is produced in Teknoform® with stone relief texture. Available in 2 sizes: W 100/120 x 50 x H 10 cm.

- **LAGUNA WASHBASIN**
Counter top washbasin in Murano glass supplied with chrome waste and base ring.

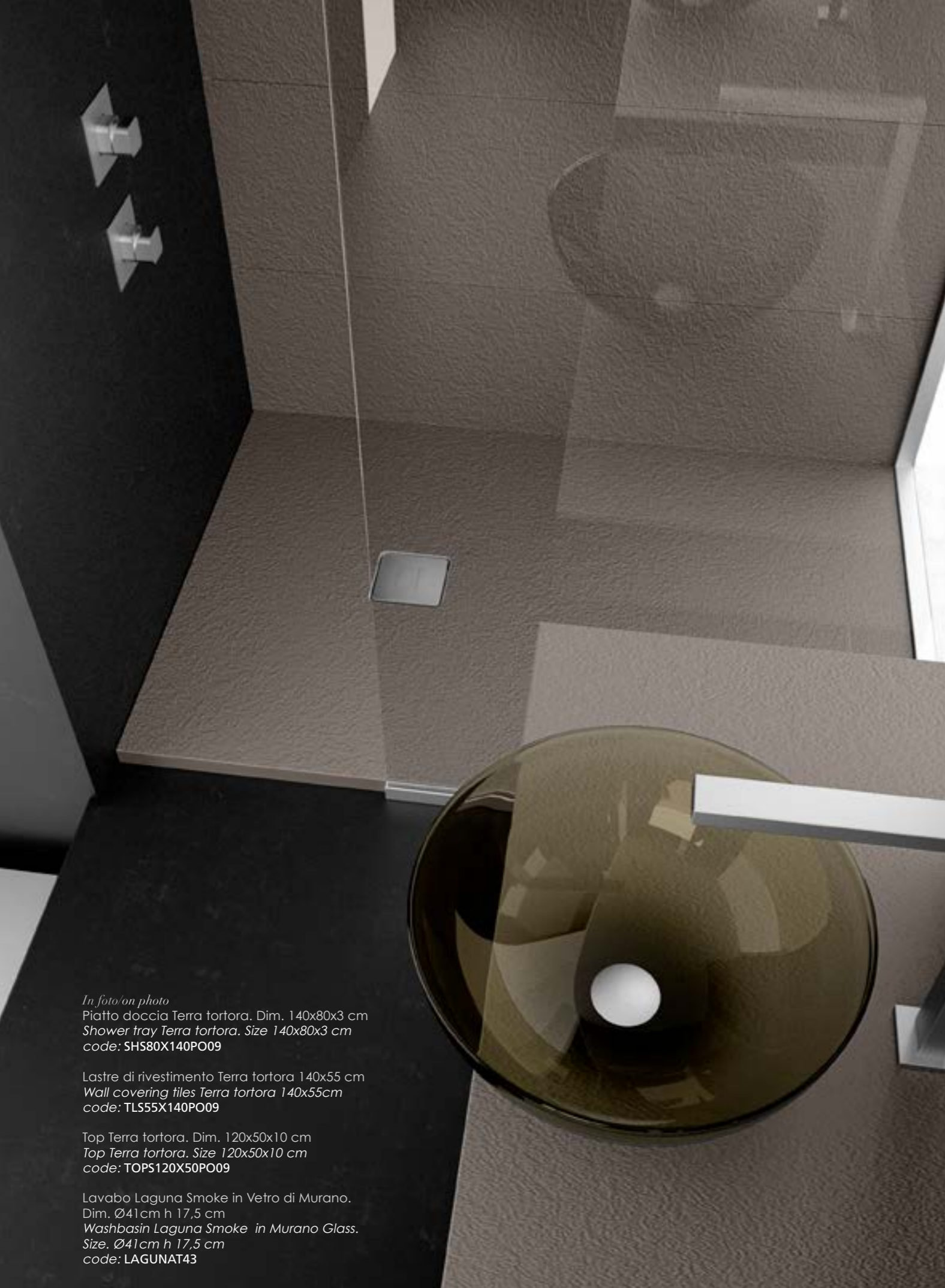

In foto/on photo

Piatto doccia Terra tortora. Dim. 140x80x3 cm
Shower tray Terra tortora. Size 140x80x3 cm
code: SHS80X140PO09

Lastre di rivestimento Terra tortora 140x55 cm
Wall covering tiles Terra tortora 140x55cm
code: TLS55X140PO09

Top Terra tortora. Dim. 120x50x10 cm
Top Terra tortora. Size 120x50x10 cm
code: TOPS120X50PO09

Lavabo Laguna Smoke in Vetro di Murano.
Dim. Ø41cm h 17,5 cm
Washbasin Laguna Smoke in Murano Glass.
Size. Ø41cm h 17,5 cm
code: LAGUNAT43



TERRA TORTORA

Texture pietra a rilievo finitura tortora.

- **PIATTI DOCCIA**
Oltre alla loro eleganza ed originalità stilistica, i piatti doccia si distinguono per la loro flessibilità di posa e l'ampio assortimento dimensionale che va da 80 cm fino ai 200 cm. Grazie allo spessore ridotto di soli 3 cm, il piatto doccia può essere installato filo pavimento o in appoggio. Ogni piatto doccia è provvisto di griglia in acciaio inox.

- **LASTRE DI RIVESTIMENTO**
Le lastre di rivestimento sono il complemento ideale per il piatto doccia. La loro lunghezza segue quella dei piatti doccia che va da 80 cm fino a 200 cm con un'altezza di 55cm.

- **TOP**
Il piano lavabo è realizzato in Teknoform®, con texture pietra a rilievo. Disponibile in 2 misure: L 100/120 x 50 x H 10 cm.

- **LAVABO LAGUNA**
Lavabo da appoggio in vetro di Murano fornito con piletta e anello cromati.

Stone relief texture tortora finish.

- **SHOWER TRAYS**
In addition to their elegance and originality of style, the shower trays are distinguished by their flexibility of installation and dimensions ranging from 80cm to 200cm. Thanks to the reduced thickness of only 3cm, the shower tray can be installed either on top or flush with the flooring. Each shower tray is supplied with a stainless steel drain.

- **WALL COVERING TILES**
Wall covering tiles are the perfect complement to the shower tray. Their sizes follow those of the shower trays with a length ranging from 80 cm to 200 cm and a height of 55 cm.

- **TOP**
The Top is produced in Teknoform® with stone relief texture. Available in 2 sizes: W 100/120 x 50 x H 10 cm.

- **LAGUNA WASHBASIN**
Counter top washbasin in Murano glass supplied with chrome waste and base ring.

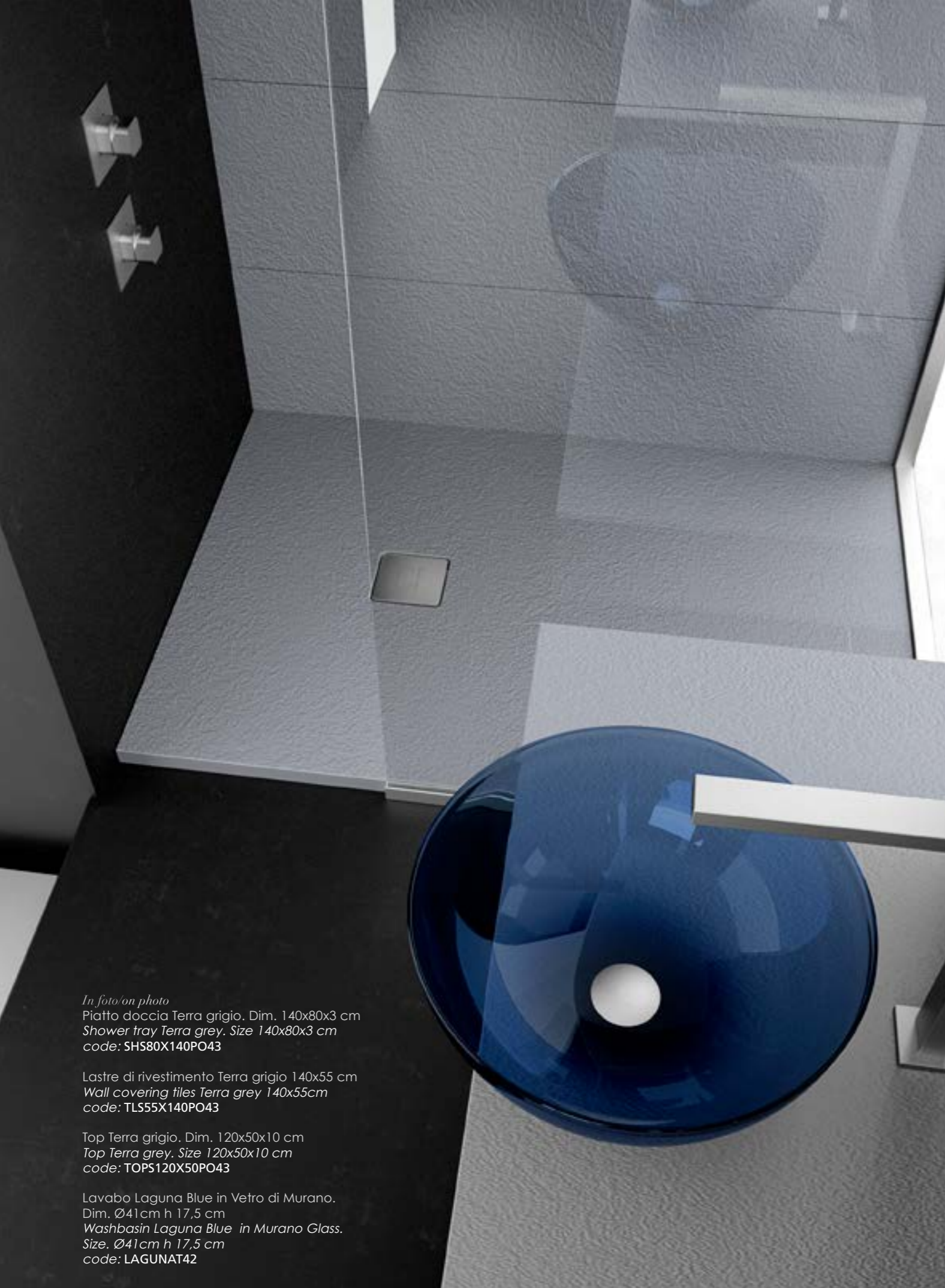

In foto/on photo

Piatto doccia Terra grigio. Dim. 140x80x3 cm
Shower tray Terra grey. Size 140x80x3 cm
code: SHS80X140PO43

Lastre di rivestimento Terra grigio 140x55 cm
Wall covering tiles Terra grey 140x55cm
code: TLS55X140PO43

Top Terra grigio. Dim. 120x50x10 cm
Top Terra grey. Size 120x50x10 cm
code: TOPS120X50PO43

Lavabo Laguna Blue in Vetro di Murano.
Dim. Ø41cm h 17,5 cm
Washbasin Laguna Blue in Murano Glass.
Size. Ø41cm h 17,5 cm
code: LAGUNAT42



TERRA GRIGIO

Texture pietra a rilievo finitura grigio. *Stone relief texture grey finish.*

• PIATTI DOCCIA

Oltre alla loro eleganza ed originalità stilistica, i piatti doccia si distinguono per la loro flessibilità di posa e l'ampio assortimento dimensionale che va da 80 cm fino ai 200 cm. Grazie allo spessore ridotto di soli 3 cm, il piatto doccia può essere installato filo pavimento o in appoggio. Ogni piatto doccia è provvisto di griglia in acciaio inox.

• LASTRE DI RIVESTIMENTO

Le lastre di rivestimento sono il complemento ideale per il piatto doccia. La loro lunghezza segue quella dei piatti doccia che va da 80 cm fino a 200 cm con un'altezza di 55cm.

• TOP

Il piano lavabo è realizzato in Teknoform®, con texture pietra a rilievo. Disponibile in 2 misure: L 100/120 x 50 x H 10 cm.

• LAVABO LAGUNA

Lavabo da appoggio in vetro di Murano fornito con piletta e anello cromati.

• SHOWER TRAYS

In addition to their elegance and originality of style, the shower trays are distinguished by their flexibility of installation and dimensions ranging from 80cm to 200cm. Thanks to the reduced thickness of only 3cm, the shower tray can be installed either on top or flush with the flooring. Each shower tray is supplied with a stainless steel drain.

• WALL COVERING TILES

Wall covering tiles are the perfect complement to the shower tray. Their sizes follow those of the shower trays with a length ranging from 80 cm to 200 cm and a height of 55 cm.

• TOP

The Top is produced in Teknoform® with stone relief texture. Available in 2 sizes: W 100/120 x 50 x H 10 cm.

• LAGUNA WASHBASIN

Counter top washbasin in Murano glass supplied with chrome waste and base ring.

TERRA



BIANCO



BEIGE

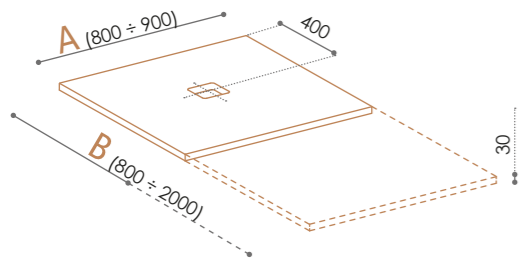

Piatti doccia
Shower trays

B	A	A
	800 mm	900 mm
cm	cod.	cod.
80	SHS80X80PO01	
90	SHS80X90PO01	SHS90X90PO01
100	SHS80X100PO01	SHS90X100PO01
110	SHS80X110PO01	SHS90X110PO01
120	SHS80X120PO01	SHS90X120PO01
130	SHS80X130PO01	SHS90X130PO01
140	SHS80X140PO01	SHS90X140PO01
150	SHS80X150PO01	SHS90X150PO01
160	SHS80X160PO01	SHS90X160PO01
170	SHS80X170PO01	SHS90X170PO01
180	SHS80X180PO01	SHS90X180PO01
190	SHS80X190PO01	SHS90X190PO01
200	SHS80X200PO01	SHS90X200PO01

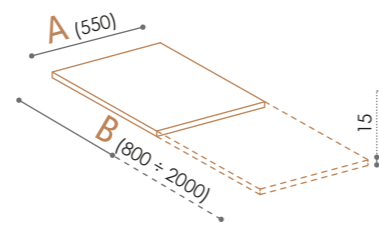

Rivestimenti
Wall covering

B	A
	550 mm
cm	cod.
80	TLS55X80PO01
90	TLS55X90PO01
100	TLS55X100PO01
110	TLS55X110PO01
120	TLS55X120PO01
130	TLS55X130PO01
140	TLS55X140PO01
150	TLS55X150PO01
160	TLS55X160PO01
170	TLS55X170PO01
180	TLS55X180PO01
190	TLS55X190PO01
200	TLS55X200PO01

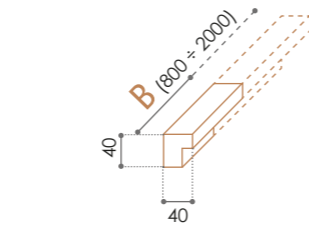

Bordo salva acqua
Water save rail

Bordo salva acqua colore bianco fornito su richiesta. Il bordo viene fornito già montato dietro disegno tecnico del cliente.
Water save rail white colour supplied upon request. In this case the rail will be supplied already assembled to the shower tray, behind customer technical drawing.

Sifone per piatti doccia a filo pavimento con foro scarico Ø90 mm.
Drain for shower tray with Ø 90 mm drain hole. Suitable for shower trays flush with the flooring.

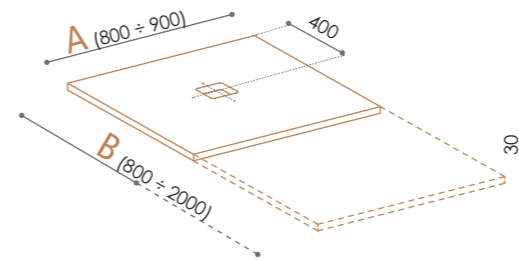
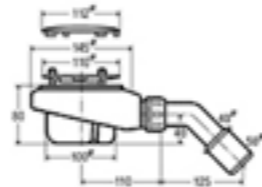

Piatti doccia
Shower trays

B	A	A
	800 mm	900 mm
cm	cod.	cod.
80	SHS80X80PO02	
90	SHS80X90PO02	SHS90X90PO02
100	SHS80X100PO02	SHS90X100PO02
110	SHS80X110PO02	SHS90X110PO02
120	SHS80X120PO02	SHS90X120PO02
130	SHS80X130PO02	SHS90X130PO02
140	SHS80X140PO02	SHS90X140PO02
150	SHS80X150PO02	SHS90X150PO02
160	SHS80X160PO02	SHS90X160PO02
170	SHS80X170PO02	SHS90X170PO02
180	SHS80X180PO02	SHS90X180PO02
190	SHS80X190PO02	SHS90X190PO02
200	SHS80X200PO02	SHS90X200PO02

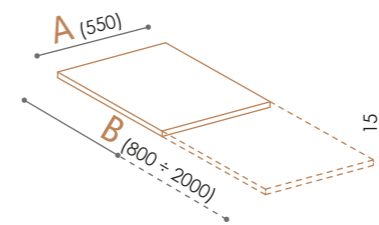

Rivestimenti
Wall covering

B	A
	550 mm
cm	cod.
80	TLS55X80PO02
90	TLS55X90PO02
100	TLS55X100PO02
110	TLS55X110PO02
120	TLS55X120PO02
130	TLS55X130PO02
140	TLS55X140PO02
150	TLS55X150PO02
160	TLS55X160PO02
170	TLS55X170PO02
180	TLS55X180PO02
190	TLS55X190PO02
200	TLS55X200PO02

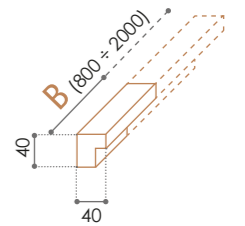

Bordo salva acqua
Water save rail

Bordo salva acqua colore beige fornito su richiesta. Il bordo viene fornito già montato dietro disegno tecnico del cliente.
Water save rail beige colour supplied upon request. In this case the rail will be supplied already assembled to the shower tray, behind customer technical drawing.

Sifone per piatti doccia a filo pavimento con foro scarico Ø90 mm.
Drain for shower tray with Ø 90 mm drain hole. Suitable for shower trays flush with the flooring.

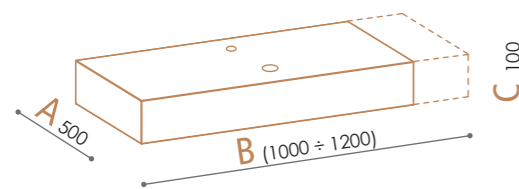
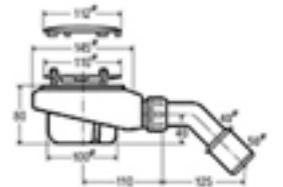

Top

B	B
1000 mm	1200 mm
cod.	cod.
TOPS100X50PO01	TOPS120X50PO01

Il top viene fornito con fori per lavabo e rubinetto come indicato sul disegno. Su richiesta sono realizzabili diametri e disposizioni diversi.

The top is supplied with pre-drilled holes as shown on the drawing. Upon request, holes can be supplied according to customer requirements.

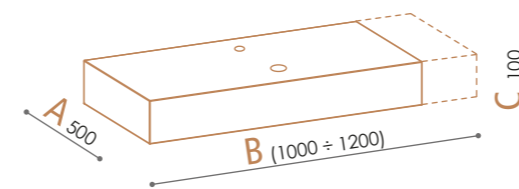
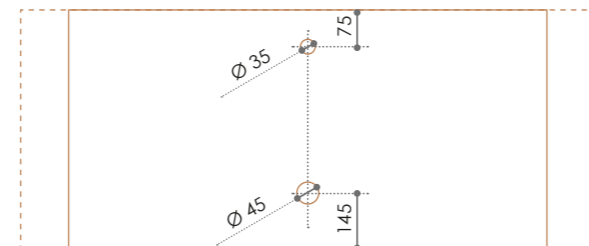

Top

B	B
1000 mm	1200 mm
cod.	cod.
TOPS100X50PO02	TOPS120X50PO02

Il top viene fornito con fori per lavabo e rubinetto come indicato sul disegno. Su richiesta sono realizzabili diametri e disposizioni diversi.

The top is supplied with pre-drilled holes as shown on the drawing. Upon request, holes can be supplied according to customer requirements.

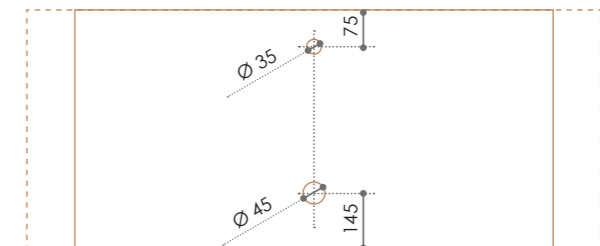

I Top sono compatibili con tutta la gamma di lavabi Glass Design.
The tops are suitable with the full range of Glass Design washbasins.

Laguna



Ø foro / hole = 45 mm
peso / weight = 4,70 kg

Base anello cromata e piletta inclusi
Chrome plug and chrome ring basement included

code:



night
LAGUNAT33



smoke
LAGUNAT43



red
LAGUNAT16



blue
LAGUNAT42

TERRA



TORTORA



GRIGIO

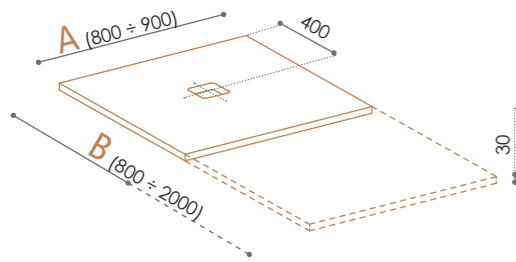

Piatti doccia Shower trays

B	A	A
	800 mm	900 mm
cm	cod.	cod.
80	SHS80X80PO09	
90	SHS80X90PO09	SHS90X90PO09
100	SHS80X100PO09	SHS90X100PO09
110	SHS80X110PO09	SHS90X110PO09
120	SHS80X120PO09	SHS90X120PO09
130	SHS80X130PO09	SHS90X130PO09
140	SHS80X140PO09	SHS90X140PO09
150	SHS80X150PO09	SHS90X150PO09
160	SHS80X160PO09	SHS90X160PO09
170	SHS80X170PO09	SHS90X170PO09
180	SHS80X180PO09	SHS90X180PO09
190	SHS80X190PO09	SHS90X190PO09
200	SHS80X200PO09	SHS90X200PO09

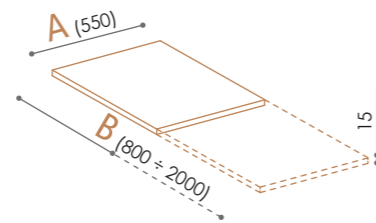

Rivestimenti Wall covering

B	A
	550 mm
cm	cod.
80	TLS55X80PO09
90	TLS55X90PO09
100	TLS55X100PO09
110	TLS55X110PO09
120	TLS55X120PO09
130	TLS55X130PO09
140	TLS55X140PO09
150	TLS55X150PO09
160	TLS55X160PO09
170	TLS55X170PO09
180	TLS55X180PO09
190	TLS55X190PO09
200	TLS55X200PO09

Bordo salva acqua Water save rail

Bordo salva acqua colore tortora fornito su richiesta. Il bordo viene fornito già montato dietro disegno tecnico del cliente.
Water save rail in tortora colour supplied upon request. In this case the rail will be supplied already assembled to the shower tray, behind customer technical drawing.

Sifone per piatti doccia a filo pavimento con foro scarico Ø90 mm.
Drain for shower tray with Ø 90 mm drain hole. Suitable for shower trays flush with the flooring.

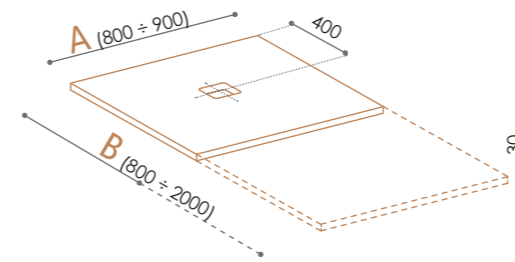
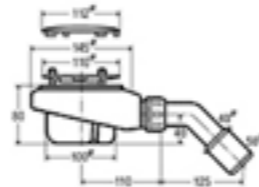

Piatti doccia Shower trays

B	A	A
	800 mm	900 mm
cm	cod.	cod.
80	SHS80X80PO43	
90	SHS80X90PO43	SHS90X90PO43
100	SHS80X100PO43	SHS90X100PO43
110	SHS80X110PO43	SHS90X110PO43
120	SHS80X120PO43	SHS90X120PO43
130	SHS80X130PO43	SHS90X130PO43
140	SHS80X140PO43	SHS90X140PO43
150	SHS80X150PO43	SHS90X150PO43
160	SHS80X160PO43	SHS90X160PO43
170	SHS80X170PO43	SHS90X170PO43
180	SHS80X180PO43	SHS90X180PO43
190	SHS80X190PO43	SHS90X190PO43
200	SHS80X200PO43	SHS90X200PO43

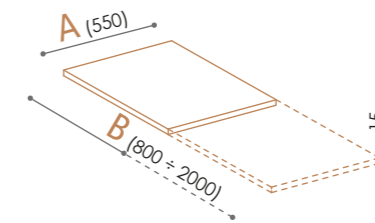

Rivestimenti Wall covering

B	A
	550 mm
cm	cod.
80	TLS55X80PO43
90	TLS55X90PO43
100	TLS55X100PO43
110	TLS55X110PO43
120	TLS55X120PO43
130	TLS55X130PO43
140	TLS55X140PO43
150	TLS55X150PO43
160	TLS55X160PO43
170	TLS55X170PO43
180	TLS55X180PO43
190	TLS55X190PO43
200	TLS55X200PO43

Bordo salva acqua Water save rail

Bordo salva acqua colore grigio fornito su richiesta. Il bordo viene fornito già montato dietro disegno tecnico del cliente.
Water save rail in grey colour supplied upon request. In this case the rail will be supplied already assembled to the shower tray, behind customer technical drawing.

Sifone per piatti doccia a filo pavimento con foro scarico Ø90 mm.
Drain for shower tray with Ø 90 mm drain hole. Suitable for shower trays flush with the flooring.

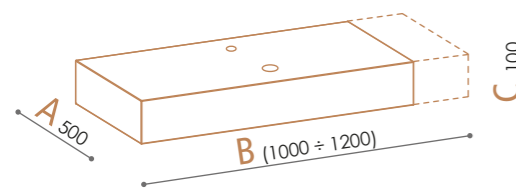
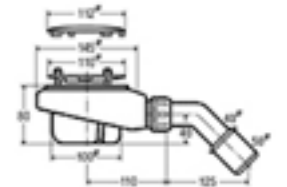

Top

B	B
1000 mm	1200 mm
cod.	cod.
TOPS100X50PO09	TOPS120X50PO09

Il top viene fornito con fori per lavabo e rubinetto come indicato sul disegno. Su richiesta sono realizzabili diametri e disposizioni diversi.

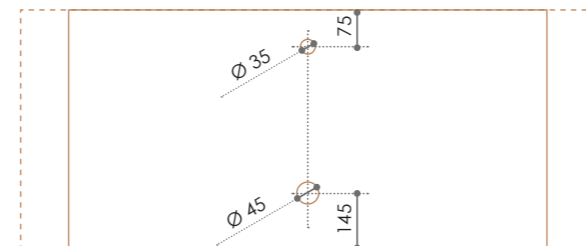

The top is supplied with pre-drilled holes as shown on the drawing. Upon request, holes can be supplied according to customer requirements.

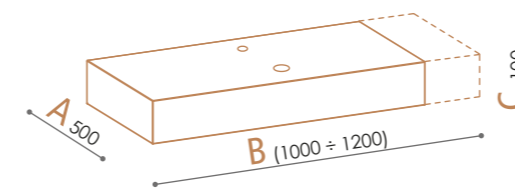

Top

B	B
1000 mm	1200 mm
cod.	cod.
TOPS100X50PO43	TOPS120X50PO43

Il top viene fornito con fori per lavabo e rubinetto come indicato sul disegno. Su richiesta sono realizzabili diametri e disposizioni diversi.

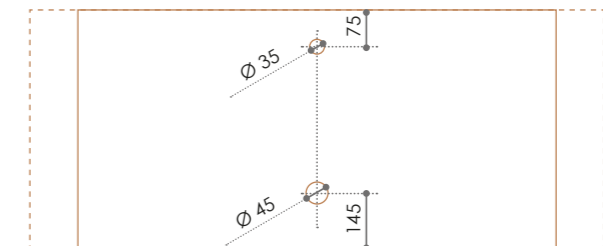

The top is supplied with pre-drilled holes as shown on the drawing. Upon request, holes can be supplied according to customer requirements.



I Top sono compatibili con tutta la gamma di lavabi Glass Design.
The tops are suitable with the full range of Glass Design washbasins.

Laguna



Ø foro / hole = 45 mm
peso / weight = 4,70 kg

Base anello cromata e piletta inclusi
Chrome plug and chrome ring basement included

code:



night
LAGUNAT33



smoke
LAGUNAT43



red
LAGUNAT16



blue
LAGUNAT42

Note Tecniche

Tutti i prodotti delle serie NATURA Lux, NATURA, TERRA Lux e TERRA sono realizzati in TeknoForm®, una resina termoindurente e cariche di minerali naturali, con esclusiva texture in legno e pietra.

Tutti gli elementi sono prodotti con pigmenti colorati, integrati nel materiale e rivestiti da un film protettivo ad elevata durezza. Il film esterno garantisce, inoltre, un'alta resistenza alle macchie e agli acidi, agevolandone la pulizia.

Entrambe le texture hanno un effetto a rilievo che rende i piatti doccia antiscivolo.

Per la pulizia quotidiana è sufficiente usare una spugna non abrasiva, acqua ed un detergente neutro (per essere sicuri che il detergente sia veramente neutro deve essere specificato sul flacone).
Non usare detergenti acidi, basi forti e solventi.

SOLO PER SERIE TERRA: nel caso in cui le superfici siano state danneggiate o graffiate, si può ripristinare mediante l'apposito kit ritocco ordinabile a catalogo.
Il kit comprende: una carta abrasiva per stendere eventuali parti taglienti dovute al danneggiamento, una resina bicomponente liquida colorata, da usare successivamente per ripristinare il film protettivo.

I piatti doccia si posano su massetto rasato impermeabilizzato, utilizzando collanti specifici quali MAPEI GRANIRAPID, KERAKOOL H40 o simili. Il collante deve essere di colore bianco.

Prima della posa, verificare che il piatto doccia sia perfettamente planare. Nel caso presenti incurvamenti dovuti all'elasticità del materiale, disporre il piatto su un piano e mantenerlo in questa posizione per circa 4 ore. Dopodiché, assicurarsi che sia tornato planare e procedere alla posa, facendo attenzione a posizionarlo in bolla, verificandolo con la livella sui 4 lati.

I piatti doccia rispettano la normativa CSA B45.5-11/IAPMO Z124 2011 riguardante la pendenza minima dell'1% che garantisce un corretto deflusso dell'acqua. A causa del fenomeno fisico denominato "tensione superficiale", correlato alla rugosità del materiale, è possibile che sulla superficie restino alcune gocce d'acqua. Questo fenomeno è accentuato nei casi in cui la durezza dell'acqua risulti essere maggiore.

Technical Remarks

All products of NATURA Lux, NATURA, TERRA Lux and TERRA are realised in TeknoForm®, a thermosetting resin with natural mineral charges, with exclusive wood and stone texture.

All the products are produced with coloured pigments, contained in the material, and covered by a protective film, with high hardness. The external film guarantees high spots and acids resistance.

Both the textures have relief effect that makes the shower tray extremely anti-slip.

*For ordinary cleaning it is enough to use a non-abrasive sponge and neutral detergent (as identified on the bottle).
Do not use acid detergents, strong bases or solvents and do not use an abrasive sponge for the cleaning of the surface.*

*ONLY FOR TERRA SERIE: in case the surfaces are damaged or scratched, it is possible to restore it with the proper maintenance kit that can be ordered from the catalogue.
The kit includes abrasive paper, which is used to round possible sharp parts caused by the damage. The bi-component liquid and coloured resin is used to restore the protective film.*

The shower bases are laid on smooth and waterproofed subfloor, using specific adhesives such MAPEI GRANIRAPID, KERAKOLL H40 or similar. The glue should be white in colour.

*Before laying, verify that the shower base is perfectly plane. In case of slight warpage, caused by the elasticity of the material, lay the shower base on a flat surface and keep it on this position for about 4 hours.
After that verify its planarity and proceed with the installation by laying the tray flat, paying attention to fit-it level and verifying it on all 4 sides*

*The shower bases are in compliance with CSA B45.5-11/IAPMO Z124 2011, regarding the minimum slope of 1% that grants a correct flow of water.
Because of the physical phenomenon called "superficial tension", in connection with the roughness of the material, it is possible that there can be some water drops on the surface.
This phenomenon can become more marked in hard water areas.*

Caratteristiche fisiche

	NORMA RIFERIMENTO	RISULTATO TEST
Durezza superficie	SCALA MOHS	3.0
Dilatazione termica lineare	UNI EN 103	27.0
Scivolosità	DIN 51097	18.4° - A + B
Resistenza a flessione	ASTM C99	N/mm ² 13.3
Resistenza a compressione	ASTM C170	369 da N/cm ²
Resistenza colori alla luce	DIN 51094	colori inalterati
Resistenza al fuoco		CL A1 - autoestingente

Resistenze chimiche secondo UNI 10944

LIQUIDO	TEMPO	VALUTAZIONE
Alcool 95°	8 ore	5
Acetone	60''	5
Caffè	8 ore	5
Olio di oliva	8 ore	5
Mercuro cromo	60''	4
Detergente < 5%	8 ore	5
Vino rosso	8 ore	5
Coca cola	8 ore	4
Rossetto	8 ore	5
Inchiostro	8 ore	5
Detergente concentrato	8 ore	5
Alcool 95%	8 ore	5
Tintura per capelli	60''	3
Anticalcare	8 ore	5
Candeggina	1 ora	5

5. nessuna variazione
 4. variazione visibile parzialmente e solo orientando opportunamente il provino
 3. variazione parziale visibile indipendentemente dall'orientamento del provino
 2. evidente variazione del provino
 1. grave danneggiamento della superficie con rottura/screpolatura del film di vernice

Physical Characteristics

	REF. LAW TEST RESULT	TEST RESULT
Surface Hardness	SCALA MOHS	3.0
Linear thermal dilatation	UNI EN 103	27.0
Slipperiness	DIN 51097	18.4° - A + B
Bending strength	ASTM C99	N/mm ² 13.3
Resistance to compression	ASTM C170	369 da N/cm ²
Colours's resistance to light	DIN 51094	unchanged colors
Fire resistance		CL A1 - self-extinguishing

Chemical Resistances according to UNI 10944

LIQUID	TIME	VALUTATION
Alcool 95°	8 H	5
Acetone	60''	5
Coffee	8 H	5
Olive Oil	8 H	5
Mercuro chromium	60''	4
Detergent	8 H	5
Red wine	8 H	5
Coke	8 H	4
Lipstick	8 H	5
Ink.	8 H	5
Conc. Detergent	8 H	5
Alcool 95%	8 H	5
Hair Dye	60''	3
Anti-limescale	8 H	5
Bleach	1 H	5

- 5- no variation
 4- variation partially visible from certain angles to the test material
 3- variation partially visible apart from any angle to the test material
 2- noticeable variation in the test material
 1- Serious damage of the surface with breaking and/or scratching of the paint film

“Accessori & Complementi”

Accessories & Complements

Dettagli di “valore”



Specchio Tondo
round mirror

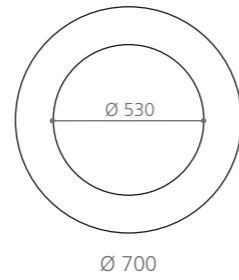

white gloss
FLOMIRROBL



white mat
FLOMIRROBO



black gloss
FLOMIRRONL



black mat
FLOMIRRONO



Ferrari red
FLOMIRROPL34



gold leaf
FLOMIRROFO



silver leaf
FLOMIRROFA



gold mat
FLOMIRROGD



dark inox mat
FLOMIRRODI



Specchio Ovale
oval mirror

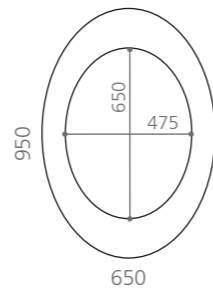

white gloss
FLOMIROVBL



white mat
FLOMIROVBO



black gloss
FLOMIROVNL

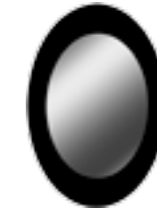

black mat
FLOMIROVNO



Ferrari red
FLOMIROVPL34



gold leaf
FLOMIROVFO



silver leaf
FLOMIROVFA



gold mat
FLOMIROVGD

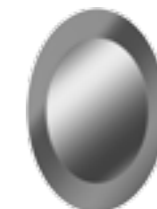

dark inox mat
FLOMIROVDI



Specchio Rettangolare
rectangular mirror

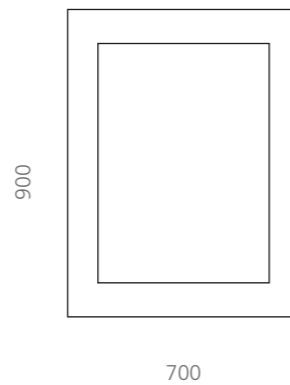

white gloss
MIRRETL



white mat
MIRRETO



black gloss
MIRRETNL



black mat
MIRRETO



Ferrari red
MIRRETPL34



gold leaf
MIRRETFO



silver leaf
MIRRETFA

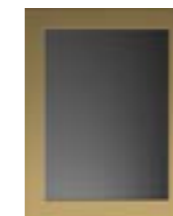

gold mat
MIRRETDG



dark inox mat
MIRRETDI



Specchio bj

bj mirror

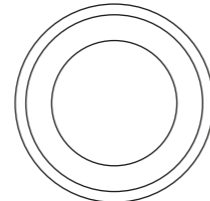

Ø 660



white / silver
ALUBJMIRA05



black / silver
ALUBJMIRA02



gold leaf 3d
ALUBJMIRFO



silver leaf 3d
ALUBJMIRFA



copper leaf 3d
ALUBJMIRFR



Specchio Misura

misura mirror

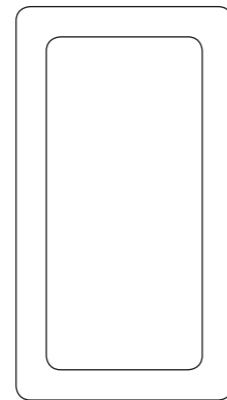

1200

670



white mat
MSMIR120X67B



black mat
MSMIR120X67N



platinum mat
MSMIR120X67PL

Piletta scarico libero

Piletta a scarico libero con logo GD
Waste with free flow plug with GD logo
(Ø 70 - H 90 mm)

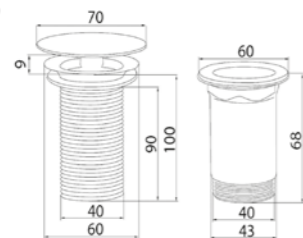

Cromo
chrome
SCCR



Ottone nero opaco
brass black mat finish
SCBL



Ottone oro
brass gold finish
SCGD

Piletta ABS scarico libero

Piletta ABS a scarico libero con logo GD
ABS waste with free flow plug with GD logo
(Ø 72 - H 90 mm)

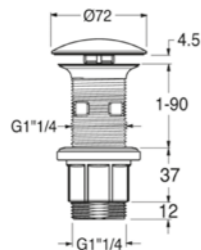

ABS cromo
ABS chrome
SCCR 100

Piletta klik-clak

Piletta klik clak con logo GD (senza troppo pieno)
Up & Down waste with GD logo (without overflow)
(Ø 63,5 - H 100 mm)

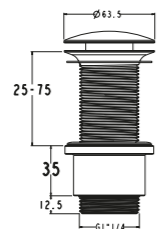

Cromo
chrome
SCCRP



Ottone nero opaco
brass black mat finish
SCBLP



Ottone oro
brass gold finish
SCGDP

Piletta ABS klik-clak

Piletta ABS klik clak con logo GD utilizzabile per lavabi senza e con troppo pieno
Up & Down ABS waste with GD logo suitable for washbasins with and without overflow
(Ø 72 - H 90 mm)



ABS cromo
ABS chrome
SCCRP 100

Piletta klik-clak

Piletta klik clak con logo GD (con troppo pieno)
Up & Down waste with GD logo (with overflow)
(Ø 63,5 - H 100 mm)

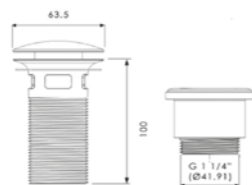

Cromo
chrome
SCCRTP



Ottone nero opaco
brass black mat finish
SCBLTP



Ottone oro
brass gold finish
SCGDTP

Piletta scarico libero tappo XL

Piletta a scarico libero con logo GD
Waste with free flow plug with GD logo
(Ø 105 - H 100 mm)

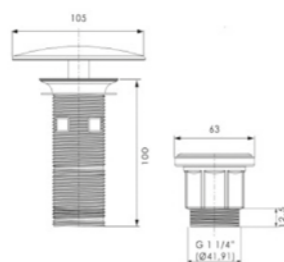

ABS cromo
ABS chrome
SCCR XL

Base anello

Base ring

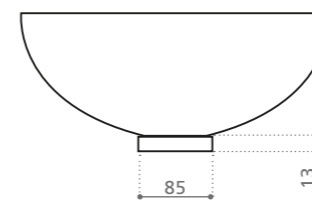

oro / gold
ANF3



Cromo / chrome
ANF4



nero opaco / black mat
ANBL

Troppo pieno

Troppo pieno completo per scarico lavabo 1" 1/4
Overflow joint for basin waste 1" 1/4

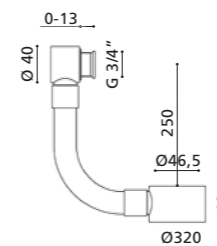

Cromo / chrome
TP



oro / gold
TPG

Troppo pieno ABS

Troppo pieno per lavabi sottopiano ABS bianco (con anello cromato)
White ABS basin overflow (with chromed ring) for under mounted wash basins

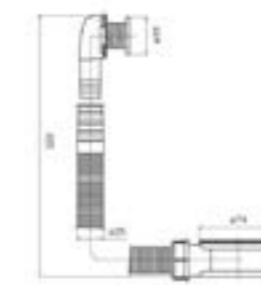

Cromo / chrome
TPA

Tondo

Sifone tondo
Round siphon

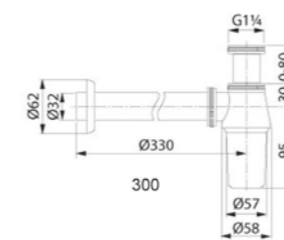

Cromo / chrome
SIFHF4



oro / gold
SIFHF3

Quadro

Sifone quadrato
Square siphon

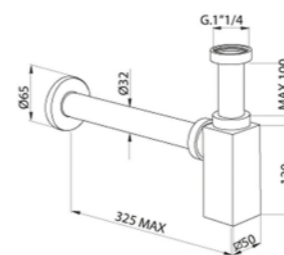

Cromo / chrome
SIFQF4



oro / gold
SIFQF3

Design senza confini Design without borders

Vetro Freddo®

Il Vetro Freddo® è un materiale innovativo, composto da pigmenti vetrosi e resine. La sua caratteristica principale è la sua versatilità nell'adattarsi a qualsiasi tipo di forma. E' l'esaltazione della materia che si esprime attraverso l'anima del suo colore. La natura della sua materia, composta da pigmenti vetrosi e pertanto trasparenti, permette al Vetro Freddo® di avere uno dei suoi principali punti di forza, e cioè la possibilità di esprimersi in colori trasparenti, traslucidi od opachi. Nessun limite quindi a livello cromatico e, oltre alla gamma di colori già esistente, è possibile scegliere in base alle proprie esigenze, uno dei numerosi colori presenti nella mazzetta "RAL". Il Vetro Freddo® ha una resistenza termica di circa 100°C e può essere lavorato con gli stessi utensili del marmo o del vetro. Tutti gli oggetti in Vetro Freddo® si possono lavare con qualsiasi tipo di sapone o detergente neutro non granulare, usando panni o spugne non abrasive. In caso di graffi superficiali, si può ripristinare l'oggetto intervenendo con un panno imbevuto di olio d'oliva o una semplice crema per le mani. In caso di graffi più profondi, è possibile ripristinare con una speciale carta vetro suggerita dal produttore in base al colore o al tipo di oggetto.

Vetro Freddo® is an innovative material composed of glass pigments and resin. Highly versatile, its aesthetic characteristics are unique in that it can present as transparent, semi-transparent or opaque due to the composition of glass pigments. Vetro Freddo is likewise heat resistant up to temperatures of 100c, and can be crafted in a fashion similar to marble or glass. With regards to colour, the possibilities are endless. Any colour from the "RAL" colour scheme can be chosen and easily adapted. Vetro Freddo can be cleaned with any type of non-granular soap, using soft sponges or tissues.

In the event of superficial damage (scratches), the damaged area should be gently rubbed with a sheet soaked in olive oil.

In the case of deeper scratches or damage, a special replacement glass paper is available from the manufacturer for the white colour.



Pert®

polimero tecnologico

Il Pert® è un polimero tecnologico dalle qualità eccezionali, che unisce un basso peso specifico ad un'elevata resistenza meccanica. Particolarmente adatto in quei settori dove l'esigenza della leggerezza del peso è fondamentale (nautico, aereo, camper...). E' un materiale che permette la realizzazione di prodotti di elevato design, eseguiti a regola d'arte, rispettando angoli, raggi, bassorilievi e planarità con la possibilità di scelta tra una vasta gamma di colori, personalizzabili a richiesta.

Pert® is a technological polymer of extraordinary quality, combining a low density with high mechanical resistance. It is particularly suited to fields where low density materials are essential (e.g. in nautical, aeronautical, camping, ...). This material likewise enables the creation of perfectly crafted angles and smooth surfaces. Products made from Pert are also available in a wide selection of colours.

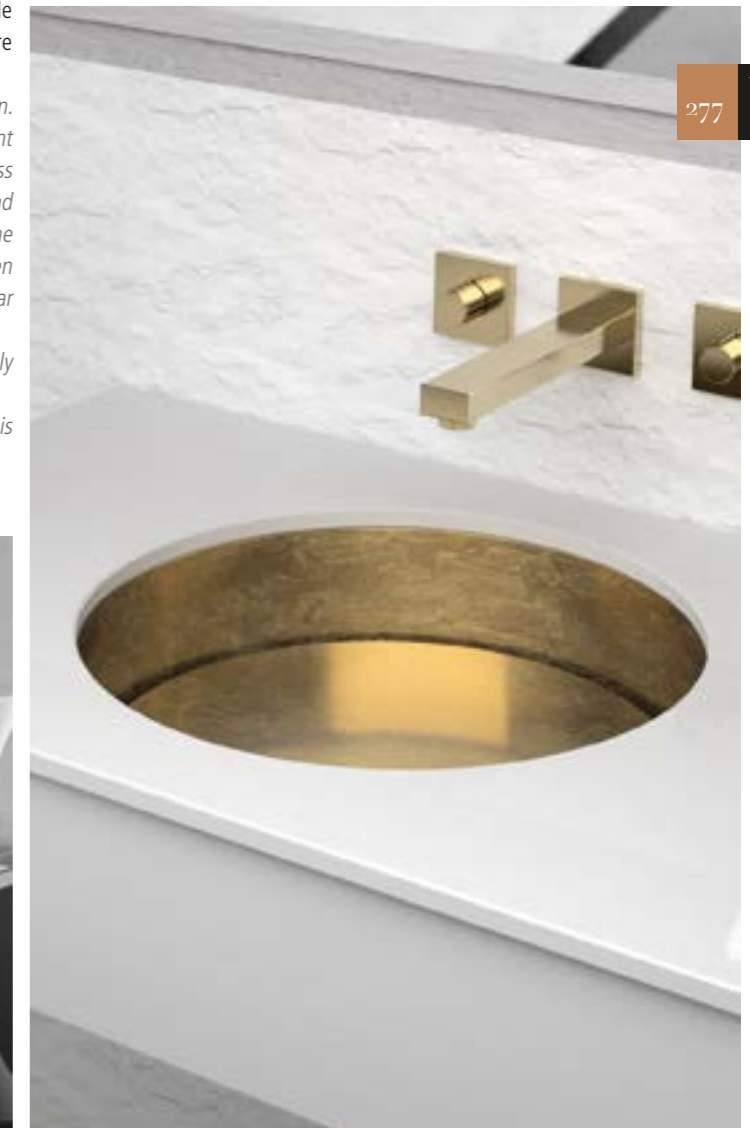

“Materiali & Certificazioni”

Materials & Certifications

Il vetro di Murano è da sempre sinonimo di raffinatezza, leggerezza ed eleganza.

I maestri vetrai hanno saputo sviluppare tecniche di lavorazioni privilegiate, nel rispetto della millenaria tradizione che rende il vetro di Murano un prodotto unico, prestigioso e inimitabile.

Murano glass is a synonym for elegance and timelessness.

By combining innovative techniques with traditional artisan workmanship, unique, prestigious and inimitable objects are created.

TeknoForm[®] è il materiale delle "texture", costituito da polimeri di varia natura, si esprime dando vita a prodotti monoscocca, esaltando le sue superfici. Dai mosaici alle pietre, dai marmi ai legni, tante soluzioni che danno vita a prodotti unici.

TeknoForm[®] is a polymer-based material, capable of mimicking a variety of textures from mosaics to stone, marble to wood, from which an incredible variety of options can be realised through the use of this material.

Prodotto hi-tech, elegante e contemporaneo che nasce da una fusione di lega di alluminio. La decorazione è realizzata a pennello, con la tecnica del graffiato, per ottenere un effetto bicromatico. Il bordo è spazzolato e lucidato a mano, per valorizzare l'anima ed il colore tipico di questo materiale.

A high-tech product, both elegant and contemporary, born from a merger of aluminum alloys. The decorations are brush-painted, employing a special brush technique in order to obtain a bi-chromatic effect. The board is brushed and polished by hand to enhance the soul and color, which are typical for this material.

Il Bi-Mat nasce dalla fusione di fibra di vetro (80%) con VetroFreddo Light, integrati tra loro per produrre un materiale innovativo, ultraleggero e resistente. La sua particolare composizione rende il prodotto estremamente versatile, conferendo leggerezza ad oggetti di grossi volumi, come nel caso delle vasche, facilitandone l'utilizzo e la collocazione. La superficie esterna si presenta bianca semilucida frutto della spazzolatura a mano ed è particolarmente idonea ad essere trattata nelle svariate tonalità cromatiche, permettendo di creare prodotti unici.

Bi-Mat is born in the merger of fiberglass (80%) and Cool Glass Light, creating an innovative material that is both lightweight and durable. Its particular composition makes the product extreme versatile, allowing objects of large volume, for example a bathtub, to be lightweight for easy use and placement. The outer surface is white gloss and brushed by hand and particularly suitable for processing in a variety of colours and allowing the creation of unique products.



INOX ZERO[®]

Nuova tecnologia applicata per dar vita ad un prodotto inox (18/8) tridimensionale.

Peso specifico ridottissimo nonostante i volumi.

Varie sono le espressioni cromatiche dal colore tipico dell'inox lucido, spazzolato fino all'ultima generazione di colori high-tech.

The products of the INOX ZERO Collection are made out of stainless steel (18/8), utilising advanced production processes enabling the combination of expressive design with of low weight. A wide range of colours can be achieved, from timeless metallic shades to prestigious brushed and avant-garde colours.

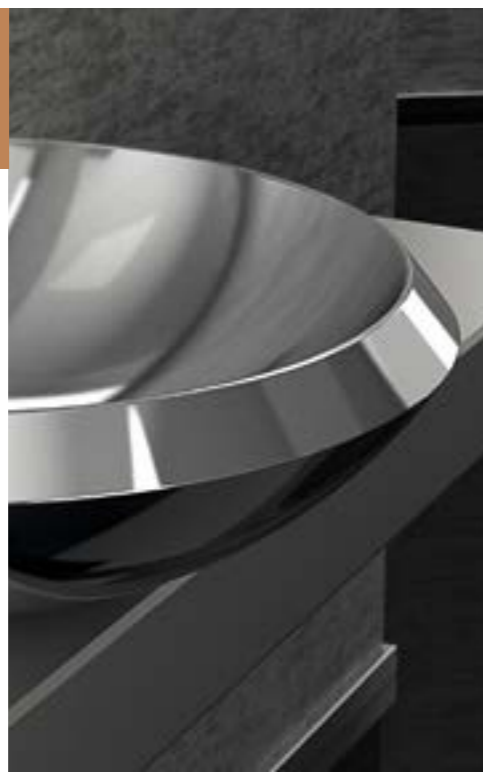

Cristallo DE' MEDICI[®]
Pb 24%

Collezioni esclusive, realizzate in cristallo purissimo al 24% pb.

Si tratta di prodotti raffinatissimi, soffiati a bocca e molati a pietra con abilità, dai nostri maestri secondo le più antiche e nobili arti vetrarie. Nessuna macchina, nessuna tecnologia, ma solo prodotti d'arte, classici, contemporanei ... futuristici.

Exclusive collections created from pure crystal with 24% lead content.

These utmost refined products are mouth-blown and bevelled in stone by our master artists according to the most ancient and noble glass arts. Neither machines nor technology are employed in the process, resulting in classical, contemporary or futuristic art products.

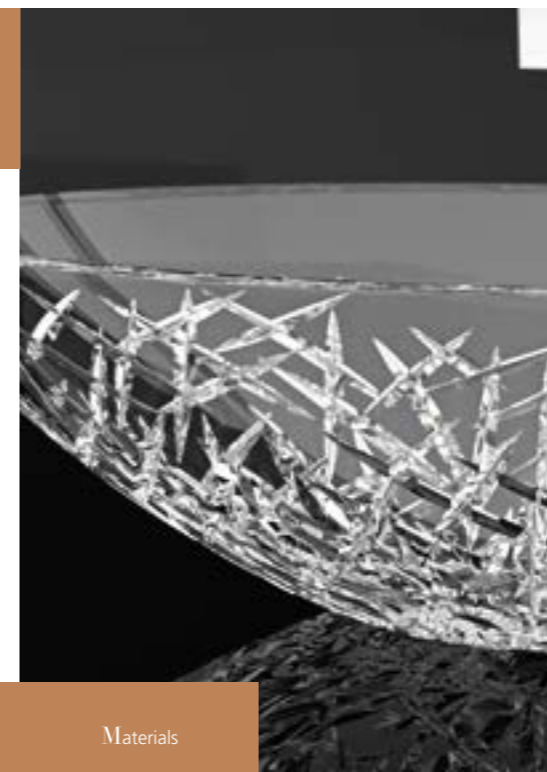

Florence Glass ATELIER[®]

Il progetto Atelier nasce dalla ricerca stilistica che una nostra equipe interna realizza rivolgendo lo sguardo al mondo della moda. I colori e le texture che vengono rappresentati nel programma sono la sintesi delle nuove tendenze.

The "Florence Glass Atelier" project aims to incorporate fashion philosophy into product research through enhancing crystal material with colours and textures of fashion trends.



Riflessi perfetti e inalterabili.

Una nuova materia dalle caratteristiche uniche.

Ottenuto attraverso un procedimento di scioglimento e cristallizzazione di ceramiche e particelle di silicio, un processo molto simile alle condizioni naturali di formazione del granito. Il suo aspetto esteriore invece è molto simile al marmo, ma con caratteristiche di durezza, lucentezza, inassorbenza e resistenza nettamente superiori. Assolutamente omogeneo, inattaccabile da qualsiasi tipo di sostanza acida o alcalina.

La tecnologia e la duttilità di questo materiale consentono di progettare l'ambiente bagno realizzando qualsiasi tipo di misura per assecondare e soddisfare le richieste più esigenti.

1 Materiale ecologico per eccellenza, ricavato da elementi naturali, non presenta né resine né solventi.

2 Riciclabile al 100%.

3 Inattaccabile dal calcare.

4 Colore inalterabile, resistente anche ad esposizioni prolungate ai raggi UV.

5 Resistente a qualsiasi prodotto usato per la pulizia del bagno.

6 Facile da pulire.

Perfect and unalterable reflections.

A new material with unique features.

It is obtained through a process of dissolution and crystallization of ceramics and silicon parts. The process is very similar to the natural characteristics of granite formation.

Its feature is very similar to marble, but with advantages in terms of hardness, brightness and resistance.

It is homogeneous, durable, acid and alkaline proof.

The technology and ductility of this material allow to design your bathroom in any customised dimensions in order to meet individual requirements.

1 Environmentally friendly; obtained from natural elements, free from resins and solvents.

2 100% recyclable.

3 Unaffected by limestone.

4 Excellent colour durability; resistant to prolonged UV rays exposure.

5 Resistant to all bathroom cleaning products.

6 Easy to clean.

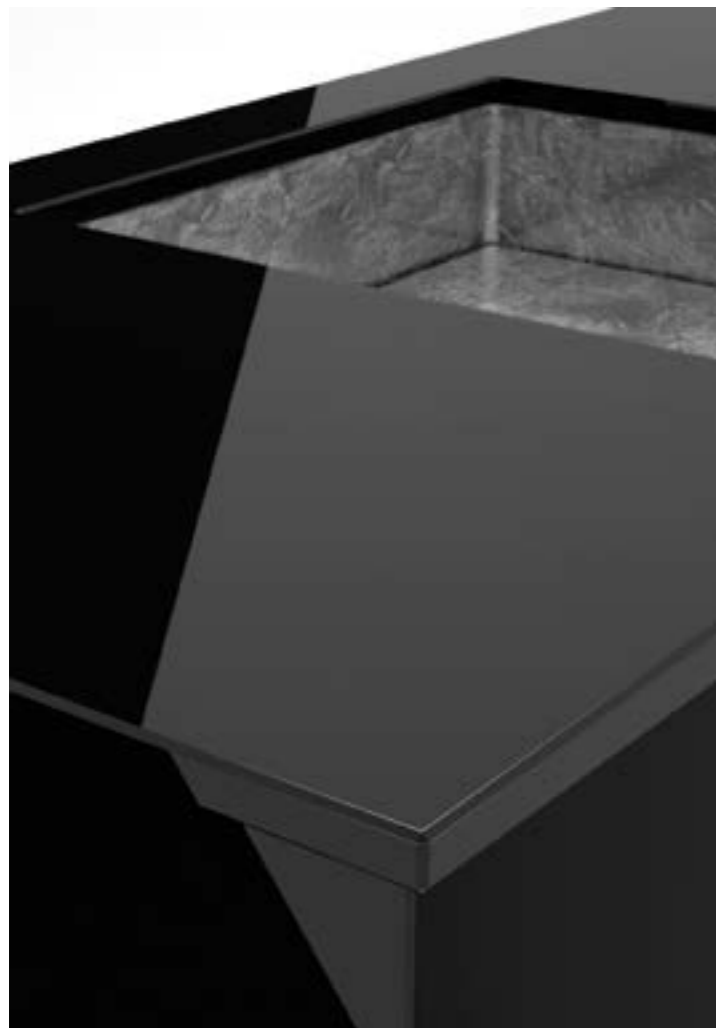

Certificazioni Full Colour Glass / Full Colour Glass certifications

RISULTATI DEI TEST CONDOTTI IN LABORATORIO UNI EN 15388:2008 / LABORATORY TESTS PERFORMANCES UNI EN 15388:2008		
UNI EN 13501-1	Reazione al fuoco <i>Fire resistance</i>	Classe A1
UNI EN 13755 UNI EN 1936	Densità apparente e assorbimento acqua <i>Apparent density and water absorption</i>	wa=0.0% - mv=2430 kg/m³
UNI EN 14617-6	Resistenza agli shock termici <i>Thermo shock resistance</i>	Nessuna variazione <i>No alterations</i>
UNI EN 14617-9	Resistenza all'urto <i>Shock resistance</i>	30 mm=4J - 18 mm=1J - 12 mm=1J
UNI EN 14617-10	Resistenza chimica <i>Chemical resistance</i>	Nessuna macchia/corrosione <i>No stain or corrosion</i>
UNI EN 12372	Resistenza a flessione <i>Flexion resistance</i>	R _{tf} =37.5 MPa
UNI EN 14617-11	Coefficiente di espansione termica lineare <i>Linear factor of thermo expansion</i>	Massima idoneità <i>maximum fitness</i>
UNI EN 14617-13	Resistenza elettrica <i>Electric resistance</i>	Massima idoneità <i>maximum fitness</i>

Certificazioni lavabi / washbasins certifications:

RISULTATI DEI TEST CONDOTTI IN LABORATORIO UNI EN 14688:2007 / LABORATORY TESTS PERFORMANCES UNI EN 14688:2007		
UNI EN 14688-par 4.2	Svuotamento dell'acqua <i>Water emptying</i>	il campione è conforme <i>The product is in conformity with the par.4.2. / UNI EN 14688:2007</i>
UNI EN 14688-par 4.4	Resistenza alle sostanze chimiche e agli agenti macchianti. <i>Resistance to chemical substances and soiling agents</i>	Non si verificano segni di deterioramento superficiali permanenti. <i>There are no signs of permanent surface deterioration.</i>
UNI EN 14688-par 4.6	Pulibilità <i>Cleanness</i>	I lavabi risultano avere superfici funzionali e conformi <i>The basins result to have surfaces which are functional and in conformity.</i>

DA VINCI
TUSCANY

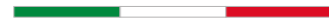

Made in Italy

CERTIFICAZIONI
CERTIFICATIONS



Tutti i prodotti della collezione Da Vinci Tuscany sono coperti da brevetti.
All products of Da Vinci Tuscany collection are patented.



è un marchio registrato da is a trademark registered by



GLASS DESIGN S.R.L.
Via Limitese, 122/124 - 50053 Vinci (Firenze) ITALY
Tel. +39 0571 902311 / +39 0571 902501
Fax +39 0571 902312
glassdesign@glassdesign.it | www.glassdesign.it

Graphic and visual design:
info@giacomomasoni.com

Copyright © Glass Design srl. Tutti i diritti riservati - All rights reserved.

stampato su carta certificata FSC®



Il marchio FSC identifica i prodotti derivanti dal legno, provenienti da foreste gestite in maniera responsabile secondo rigorosi standard ambientali, sociali ed economici.



www.glassdesign.it