

BETWEEN TRADITIONAL ELEGANCE AND CONTEMPORARY LIFE



Dornbracht VAIA

Create a new
balance



EDITORIAL
p.03

ARCHITECTURE
p.05

de Cárdenas
- p. RDC-01

Neri & Hu
- p. NH-01

BALANCE
p.40

DORN BRACHT VAIA
p.44

FORMATION
p.54

Culturing Life

EN Transitional Style, a healthy balance between tried-and-tested features and new characteristics that is thought through, inviting and quickly makes you feel at home.

IT Transitional Style, un sano equilibrio tra convenzionale e nuovo, ponderato, accogliente e che fa subito sentire a casa propria.

ES Transitional Style, un equilibrado balance entre lo nuevo y lo conocido, meditado, acogedor y que proporciona la sensación de estar en casa.

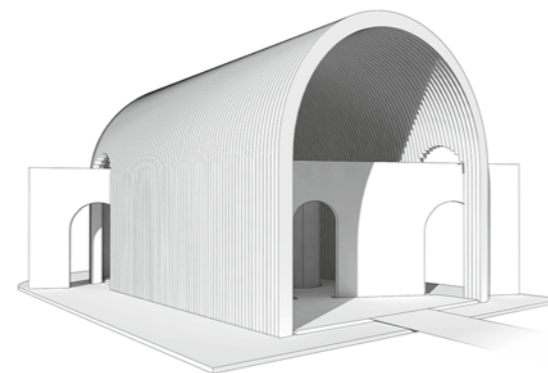

3D model:
Rafael de Cárdenas

BETWEEN TRADITIONAL ELEGANCE AND CONTEMPORARY COOL



ARCHITECTURE
Rafael de Cárdenas
p. 04



ARCHITECTURE
Neri & Hu
p. 22

DORNBACHT VAIA
DARK PLATINUM MATT
p. 52



CREATE A NEW BALANCE
p. 40

DORNBACHT VAIA
p. 44

PRODUCT INFORMATION
p. 54

EDITORIAL
p. 03

ARCHITECTURE
p. 05

Rafael de Cárdenas
– p. RDC-01

Neri & Hu
– p. NH-01

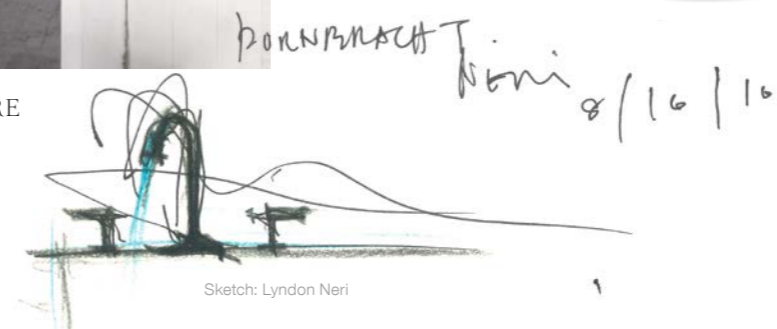

Sketch: Lyndon Neri

EDITORIAL

DEAR READER,

EN The analysis of current design trends has always been an important source of inspiration for Dornbracht. VAIA is another result of this engagement with current culture. Inspired by the interior design trend Transitional Style, VAIA harmoniously integrates into bathroom architectures, combining traditional elegance with contemporary clarity. Just how versatile and innovative this combination can look is demonstrated by the concepts created by Rafael de Cárdenas and Neri & Hu. The New York interior designer and the architectural office established in Shanghai have each designed an impressive vision for us, showing their personal interpretation of the term "transitional".

ES El análisis de las corrientes de diseño actuales ha sido desde siempre una importante fuente de inspiración para Dornbracht. VAIA también es el resultado de esta dedicación con la cultura actual. Inspirada en la tendencia interior Transitional Style VAIA se integra con armonía en las arquitecturas del cuarto de baño que unen la elegancia tradicional con la claridad contemporánea. Las ideas de Rafael de Cárdenas y Neri & Hu nos muestran lo polifacética e innovadora que puede lucir esta unión. El diseñador de interiores neoyorquino y el despacho de arquitectos establecido en Shanghai han proyectado para nosotros dos visiones impresionantes de lo que cada uno entiende por "Transitional".

Andreas Dornbracht

IT La contrapposizione tra correnti creative attuali per Dornbracht è da sempre un'importante fonte d'ispirazione. Anche VAIA è il risultato di questo rapporto con la cultura odierna. Ispirata al trend d'interior design Transitional Style VAIA s'inserisce armoniosamente nell'architettura del bagno, conciliando l'eleganza tradizionale con la linearità contemporanea. La varietà e l'innovazione di questo collegamento è dimostrata dalle idee di Rafael de Cárdenas e Neri & Hu. Il designer d'interni newyorchese e lo studio d'architettura con sede a Shanghai hanno progettato per noi una visione entusiasmante di ciò che intendono con il termine "transitional".

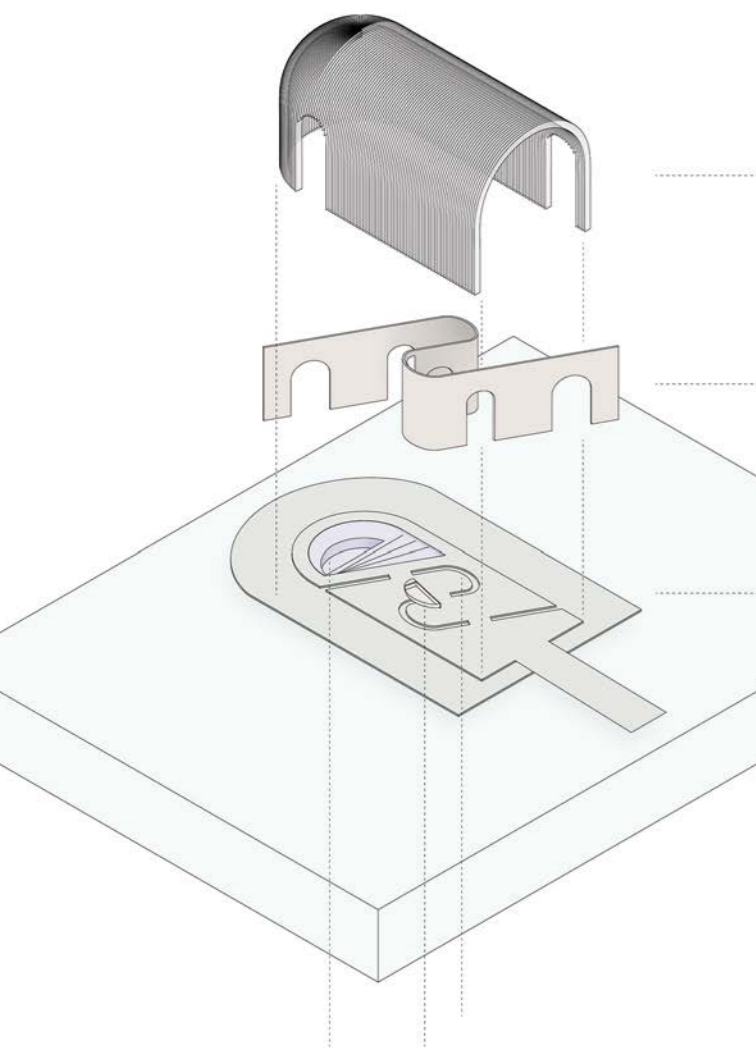

"We favour the strategic over the thematic, the cosmopolitan over the typological and the atmospheric over the static. Ever focused on the contemporary, we take diligent note of the past while day-dreaming the future."

Rafael de Cárdenas



"In Asia, water to us is not just something that is for drinking, it's not just something for cleansing, for us, water means a lot of emotional healing and physical healing."

Lyndon Neri

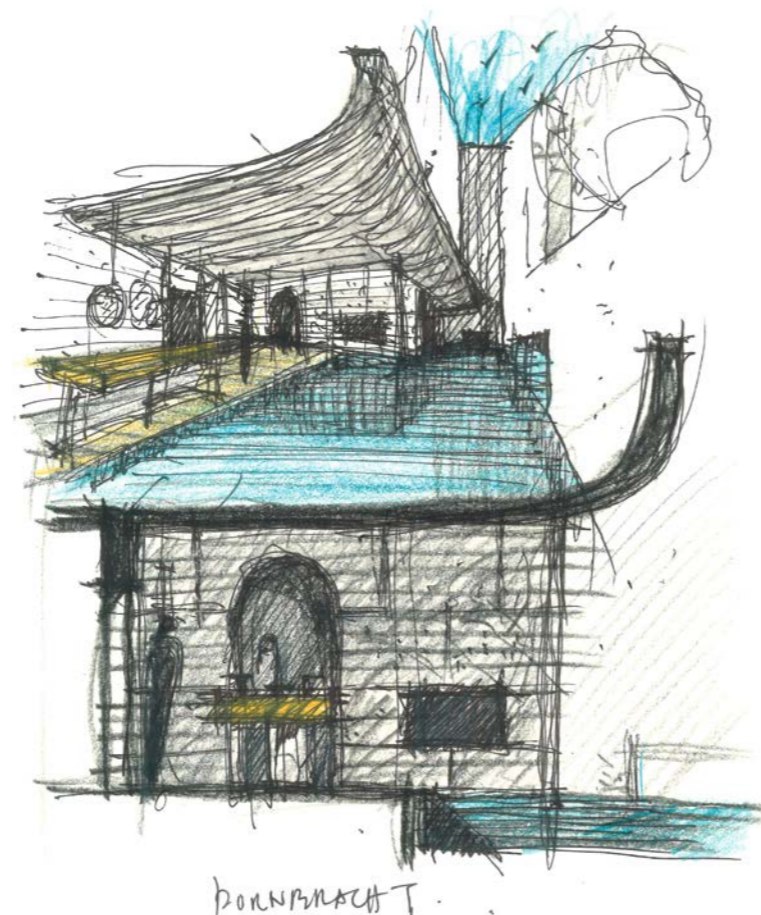

FROM PAST TO PRESENT

p. RDC-01

Inspired by the ideas of Rafael de Cárdenas.

EN Brick and Corian, smoked glass and moss, bog oak, marble and DARK PLATINUM MATT, cognac-coloured leather and purple carpeted floors: here traces of wear meet new gloss, curved arches meet monoliths rich in edges, nature meets architecture. The bathroom as a progressive area of tension between tradition and modernity. Thus the fluid boundaries of Transitional Style are impressively in motion.

IT Mattoni e Corian, vetro brunito e muschio, legno nero, marmo e DARK PLATINUM MATT, pelle colore cognac e moquette viola: tracce d'usura s'incontrano qui con una nuova brillantezza, archi accentuati con monoliti spigolosi, natura con architettura. Il bagno come un'area di raffronto tra tradizione e modernità. I limiti fluidi del Transitional Style così risultano in un continuo ed inaspettato movimento.

ES Ladrillo y Corian, vidrio ahumado y musgo, roble fósil, mármol y DARK PLATINUM MATT, cuero color coñac y moqueta violeta. Las marcas del uso se encuentran con un nuevo brillo, los arcos ondeantes con monolitos angulados y la naturaleza con la arquitectura. El baño como expresión progresiva del conflicto entre la tradición y lo moderno. Los difusos límites del Transitional Style se ponen en movimiento de forma impresionante.

INDEX

- 01 Bog oak Legno nero Roble fósil
- 02 Smoked glass Vetro brunito Cristal ahumado
- 03 Moss Muschio Musgo
- 04 Corian Corian Corian
- 05 Travertine Travertino Travertino
- 06 Brick Mattoni Ladrillo
- 07 Leather Pelle Cuero
- 08 Ceramic Cerámica Cerámica
- 09 Marble Marmo Mármol
- 10 Dark Platinum matt
- 11 Tufted shag Tappeto shag Alfombra de nudos





8

A raw brickwork lattice curved into a niche and inside: a monolithic washstand made from cubes of various materials.

Un abbinamento rustico con mattoni che formano una nicchia concava che all'interno ospita un lavabo monolitico realizzato con cubi di materiali diversi.

Una unión de ladrillo bruto ondeante sobre un nido para formar un hueco y, dentro: un lavabo monolítico de cubos de diferentes materiales.







Elegant and mysterious: VAIA in DARK PLATINUM MATT
with a dark under-mounted basin, tone-on-tone with the washstand.

Prezioso e segreto: VAIA in DARK PLATINUM MATT
con lavabo sottopiano, tono su tono con il piano del lavabo.

Noble y misterioso: VAIA en DARK PLATINUM MATT,
con una encimera oscura del mismo tono que el lavabo.



Contrast of the textures: smooth, precisely worked materials meet rough, original surfaces.

Contrasto tra le strutture: materiali lisci e lavorati con precisione incontrano superfici grezze e primordiali.

Contraste de las texturas: los materiales lisos, trabajados con precisión, se encuentran con superficies crudas y naturales.





Natural, organic shapes and functional, clear-cut lines: the round bathtub and the free-standing bath mixer in DARK PLATINUM MATT fit perfectly into the architecture.

Forme naturali ed organiche e linee chiare e funzionali: la vasca da bagno rotonda e la sua rubinetteria freestanding in DARK PLATINUM MATT s'inseriscono perfettamente nell'architettura.

Formas orgánicas naturales y líneas claras y funcionales: la bañera redonda y la batería para bañera montada de forma independiente en DARK PLATINUM MATT se integran perfectamente en la arquitectura.



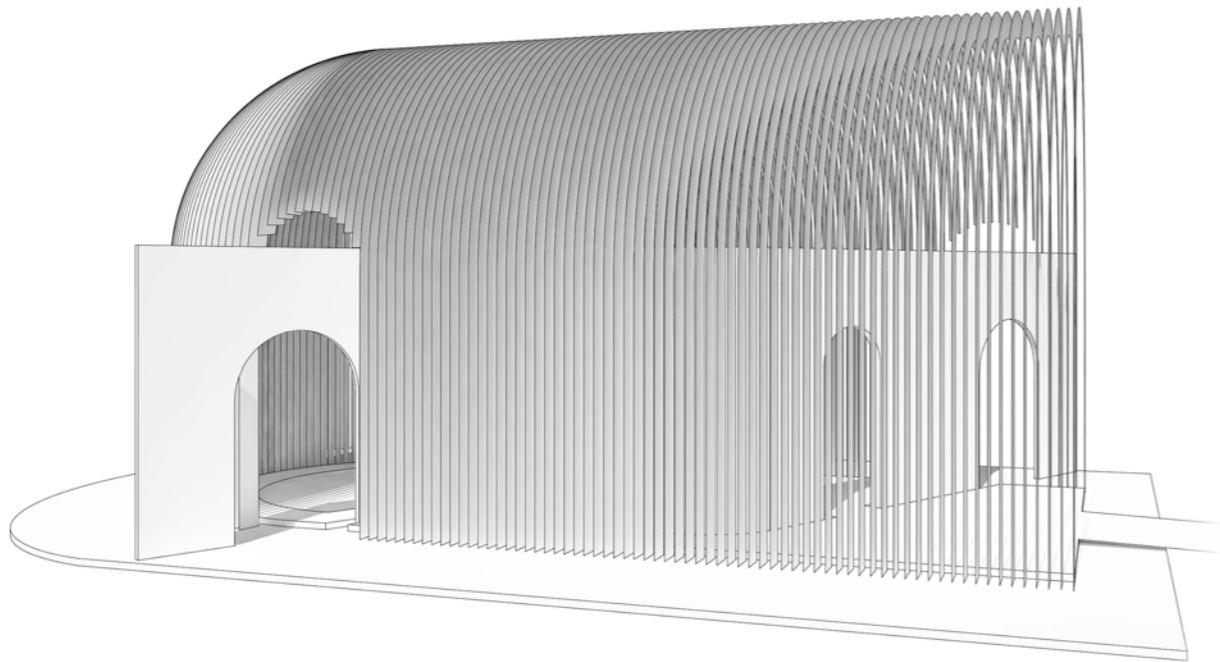
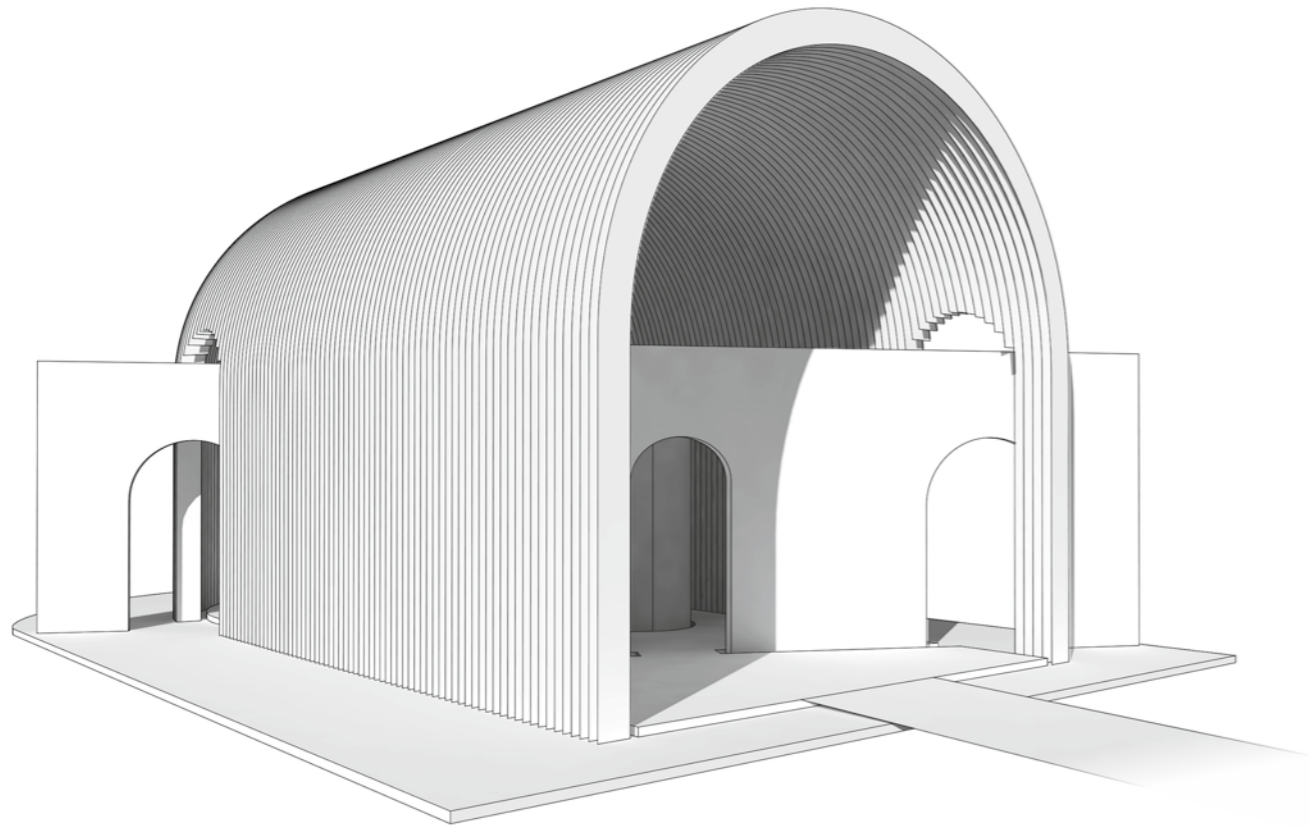

TRANSITIONAL STYLE
A draft by Rafael de Cárdenas

A video on the creation of the
VAIA architecture can be found at:

dornbracht.com/vaia

Il filmato sulla nascita dell'architettura
VAIA può essere visto all'indirizzo:

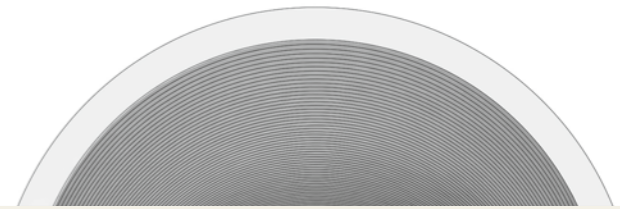

by
RAFAEL DE CÁRDENAS

ARCHITECTURE AT LARGE
New York

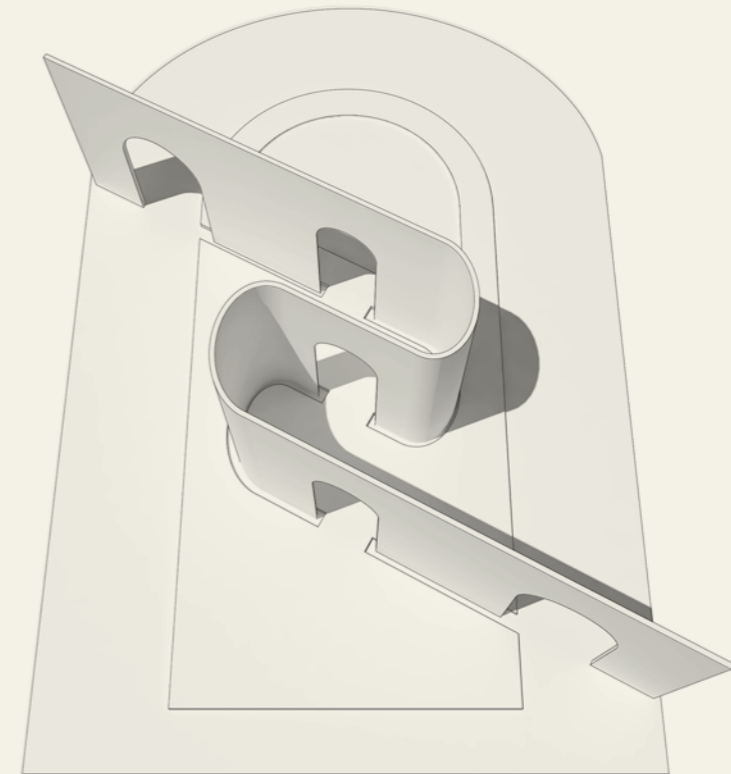

EN

“We favour the STRATEGIC over
the THEMATIC, the COSMOPOLITAN
over the TYPOLOGICAL and
the ATMOSPHERIC over the STATIC.

Ever focused on the CONTEMPORARY,
we take diligent note of
the PAST while DAY-DREAMING
the FUTURE.”

RDC-01

TRANSITIONAL STYLE
A draft by Rafael de Cárdenas

A video on the creation of the
VAIA architecture can be found at:

dornbracht.com/vaia

Il filmato sulla nascita dell'architettura
VAIA può essere visto all'indirizzo:

Rafael de Cárdenas
ARCHITECTURE AT LARGE, NEW YORK

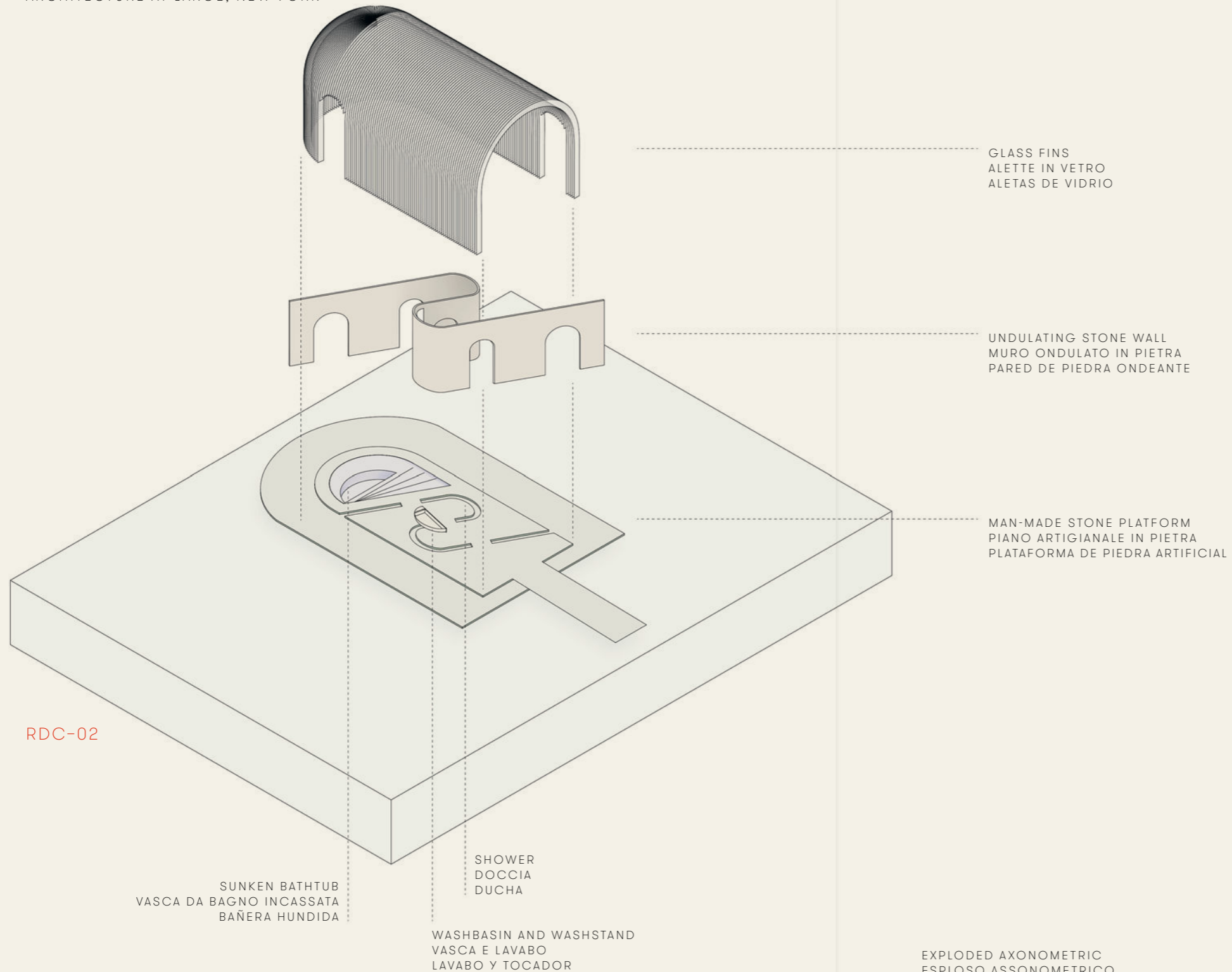

EN

RAFAEL DE CÁRDENAS' interpretation of Transitional Style is distinguished, in particular, through the unusual shape of the room. Chapel-like niches with an almost sacred momentum are created from the gentle, curved S-shape of the floor plan. The arches connecting the different zones strongly express this theme. The transparent dome which admits natural light, literally keeps the architecture open to the recurring rhythm of day and night. Traditional elegance and new ideas are combined here in an extravagant manner.

IT

L'interpretazione dello Transitional Style di RAFAEL DE CÁRDENAS affascina soprattutto per i suoi volumi insoliti. Così dalla morbida forma sinuosa ad S si sviluppano nicchie a cappella con un'allure quasi sacrale. Gli archi delle porte che collegano le diverse zone replicano con continuità questo tema. E la cupola trasparente da cui filtra la luce naturale mantiene l'architettura letteralmente aperta al ciclo alternarsi di giorno e notte. Eleganza tradizionale e nuove idee si fondono qui con originalità.

ES

La interpretación de RAFAEL DE CÁRDENAS del Transitional Style impresiona sobre todo por la inusual forma del espacio. Así, de la suave y ondeante forma en S del plano surgen unos nidos que, como un oratorio, crean un momento casi sagrado. Los arcos de las puertas que unen las diferentes zonas continúan con este motivo principal consecuentemente. Y la cúpula transparente que deja pasar la luz natural mantiene la arquitectura literalmente abierta al repetitivo ritmo del día y de la noche. La elegancia tradicional y las nuevas ideas se mezclan aquí con extravagancia.

EXPLODED AXONOMETRIC
ESPLOSO ASSONOMETRICO
AXONOMETRÍA EXPLOTADA

TRANSITIONAL STYLE
A draft by Rafael de Cárdenas

A video on the creation of the
VAIA architecture can be found at:

dornbracht.com/vaia

Il filmato sulla nascita dell'architettura
VAIA può essere visto all'indirizzo:

IT

“Preferiamo la STRATEGIA alla
TEMATICA, il COSMOPOLITISMO
alla TIPOLOGIA e L'ATMOSFERA
alla STATICA.

Sempre attenti alla
CONTEMPORANEITÀ abbiamo un
occhio di riguardo verso il PASSATO
per IMMAGINARE il FUTURO.”

RDC-04

ES

“Damos prioridad a la ESTRATEGIA sobre
la TEMÁTICA, a lo COSMOPOLITA sobre lo
TIPOLÓGICO y a lo ATMOSFÉRICO sobre
lo ESTÁTICO.

Siempre centrados en lo CONTEMPORÁNEO,
tomamos buena nota del PASADO mientras
SOÑAMOS con el FUTURO.”

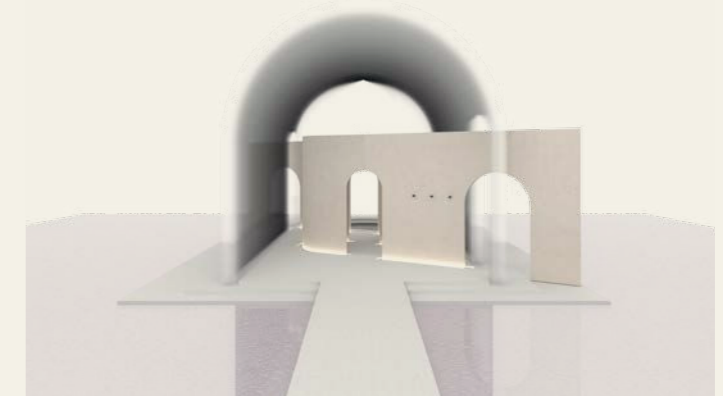

VIEW FROM THE ENTRANCE
VISTA DALL'ENTRATA
VISTA DESDE LA ENTRADA

RDC-05

TRANSITIONAL STYLE
A draft by Rafael de Cárdenas

A video on the creation of the
VAIA architecture can be found at:

dornbracht.com/vaia

Il filmato sulla nascita dell'architettura
VAIA può essere visto all'indirizzo:



VIEW FROM WASHSTAND
VISTA DELLA DOCCIA
VISTA DESDE LA DUCHA

VIEW OF WASHSTAND
VISTA DELLA ZONA LAVABO
VISTA DEL ÁREA DEL TOCADOR

TRANSITIONAL STYLE
A draft by Rafael de Cárdenas

A video on the creation of the
VAIA architecture can be found at:

dornbracht.com/vaia

Il filmato sulla nascita dell'architettura
VAIA può essere visto all'indirizzo:



VIEW OF BATH AREA
VISTA DELLA ZONA BAGNO
VISTA DEL ÁREA DE LA BAÑERA

RDC-08

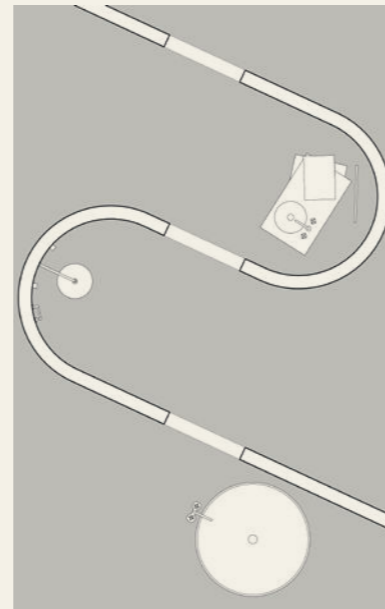

FLOOR PLAN
PLANIMETRIA
PLANO DEL SUELO

EN

A B O U T

R a f a e l d e C á r d e n a s

RAFAEL DE CÁRDENAS / ARCHITECTURE AT LARGE is a seasoned resource for design vision and execution with wide-ranging projects in architecture, residential and commercial interiors, temporary spaces, furniture and integrated objects. The practice was founded by Rafael de Cárdenas in 2006 as a small office in Chinatown, NYC, and has now expanded to two continents with offices in New York and London.

RAFAEL DE CÁRDENAS / ARCHITECTURE AT LARGE maintains a small, dedicated staff of professional designers with diverse backgrounds that range from fashion design to dance to research science. Working with an international team of collaborators including artists, fabricators and artisans, the studio is currently developing projects in North America, Eastern and Western Europe, and Asia.



PHOTO CREDIT:
GUILLAUME GAUDET

RDC-09

IT

ABOUT

Rafael de Cárdenas

RAFAEL DE CÁRDENAS / ARCHITECTURE AT LARGE è una risorsa competente di soluzioni e realizzazione di design con progetti di vasta portata in architettura, interni residenziali e commerciali, spazi temporanei, arredamento ed oggetti integrati. Lo studio è stato fondato da Rafael de Cárdenas nel 2006 in un piccolo ufficio di Chinatown, New York City, ed oggi è diffuso su due continenti con sedi a New York e Londra.

RAFAEL DE CÁRDENAS / ARCHITECTURE AT LARGE mantiene una piccola squadra dedicata di designer professionisti con background diversi che spaziano dal design della moda alla danza alla scienza della ricerca. Lavorando con una squadra di collaboratori internazionali compresi artisti, fabbricanti ed artigiani lo studio attualmente realizza progetti in Nordamerica, Europa Orientale ed Occidentale ed Asia.

RDC-10

ES

ABOUT

Rafael de Cárdenas

RAFAEL DE CÁRDENAS / ARCHITECTURE AT LARGE es un experto en la visión y la ejecución del diseño con un amplio espectro de proyectos en arquitectura, interiores residenciales y comerciales, espacios temporales, mobiliario y objetos integrados. El despacho fue fundado por Rafael Cárdenas en 2006 como una pequeña oficina en el Chinatown de Nueva York y ahora se ha extendido a dos continentes con oficinas en Nueva York y Londres.

RAFAEL DE CÁRDENAS / ARCHITECTURE AT LARGE mantiene un personal reducido y dedicado de diseñadores profesionales con diferentes orígenes que van desde el diseño de moda hasta la investigación científica, pasando por el baile. Con un equipo internacional de colaboradores que incluye artistas, productores y artesanos, el estudio se encuentra en pleno desarrollo de proyectos en Norteamérica, Europa oriental y occidental, y Asia.

TRANSITIONAL STYLE
A draft by Rafael de Cárdenas

A video on the creation of the
VAIA architecture can be found at:

dornbracht.com/vaia

Il filmato sulla nascita dell'architettura
VAIA può essere visto all'indirizzo:



RAFAEL DE CÁRDENAS



MATERIAL MOODBOARD / FIRST DRAFTS
MOODBOARD MATERIALI / PRIME BOZZE
MOODBOARD DE MATERIALES / PRIMEROS BOCETOS

RDC-11

RAFAEL DE CÁRDENAS
architectureatlarge.com

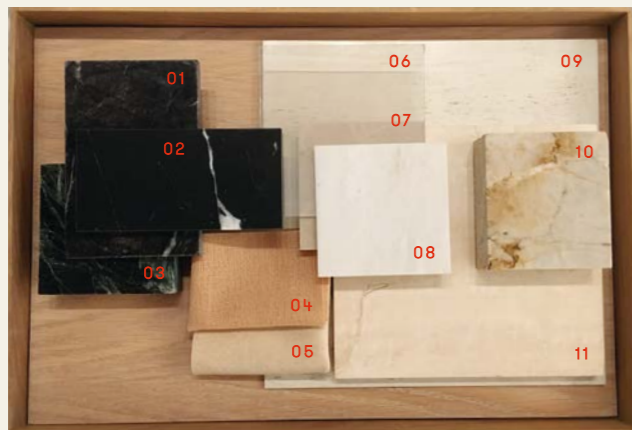

MATERIAL SELECTION PROCESS
PROCESSO SCELTA MATERIALI
PROCESO DE SELECCIÓN DE MATERIALES

FLOORING OPTIONS
OPZIONI PAVIMENTI
OPCIONES PARA EL SUELO

- 01 Polished Noir Saint Laurent marble
Marmo nero Saint Laurent lucidato
Mármol Noir Saint Laurent pulido
- 02 Honed Noir Saint Laurent marble
Marmo nero Saint Laurent levigato
Mármol Noir Saint Laurent bruñido
- 03 Honed Verde Saint Denis marble
Marmo verde Saint Denis levigato
Mármol Verde Saint Denis bruñido

UPHOLSTERY
TAPPEZZERIA
TAPICERÍA

- 04 Speckled nude and beige wool fabrics
Tessuti nude e beige maculati in lana
Tejidos desnudos y beige de lana moteada

GLASS FINIS
ALETTE IN VETRO
ALETAS DE VIDRIO

- 05 Bendheim: transparent one-way
mirror-effect glass
Bendheim: vetro trasparente effetto
specchio unilaterale
Bendheim: vidrio transparente con
efecto espejo unidireccional

CURVED WALL OPTIONS
OPZIONI MURO RICURVO
OPCIONES PARA LAS PAREDES CURVAS

- 06 Honed Botticino marble
Marmo Botticino levigato
Mármol Botticino bruñido
- 07 Honed white quartzite
Quarzite bianca levigata
Cuarcita blanca bruñida
- 08 Special paint finish, faux marble effect
Finitura in pittura speciale, effetto
finto marmo
Acabado con pintura especial, efecto
de falso mármol
- 09 Honed Crema marble
Marmo crema levigato
Mármol Crema bruñido
- 10 Honed travertine
Travertino levigato
Travertino bruñido

Photo credit for all images:
Rafael de Cárdenas / Architecture at Large

TRANSITIONAL STYLE
A draft by Rafael de Cárdenas

A video on the creation of the
VAIA architecture can be found at:

dornbracht.com/vaia

Il filmato sulla nascita dell'architettura
VAIA può essere visto all'indirizzo:

dornbracht.com/vaia

Encontrará el vídeo sobre el origen
de la arquitectura VAIA en:

dornbracht.com/vaia

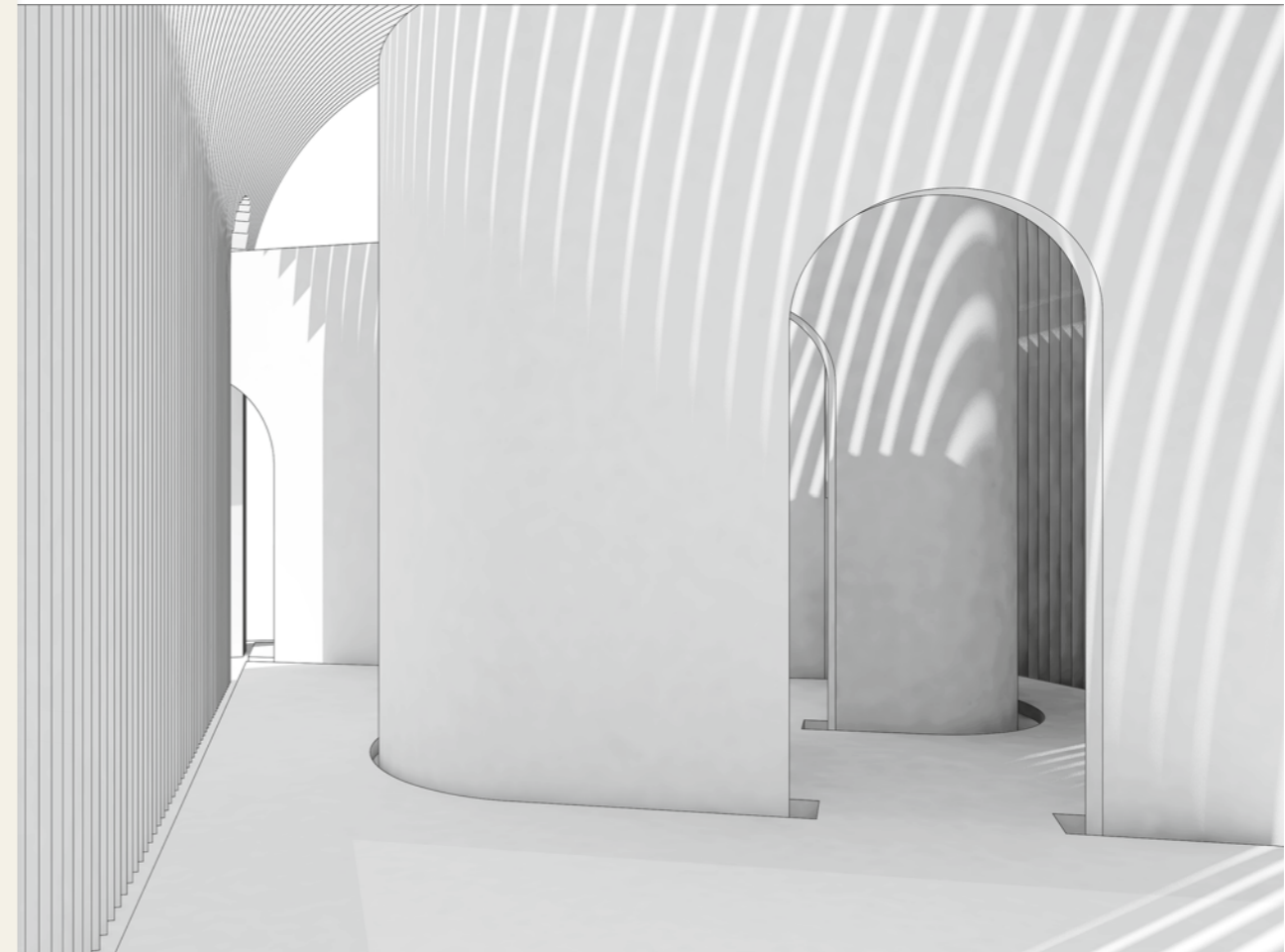
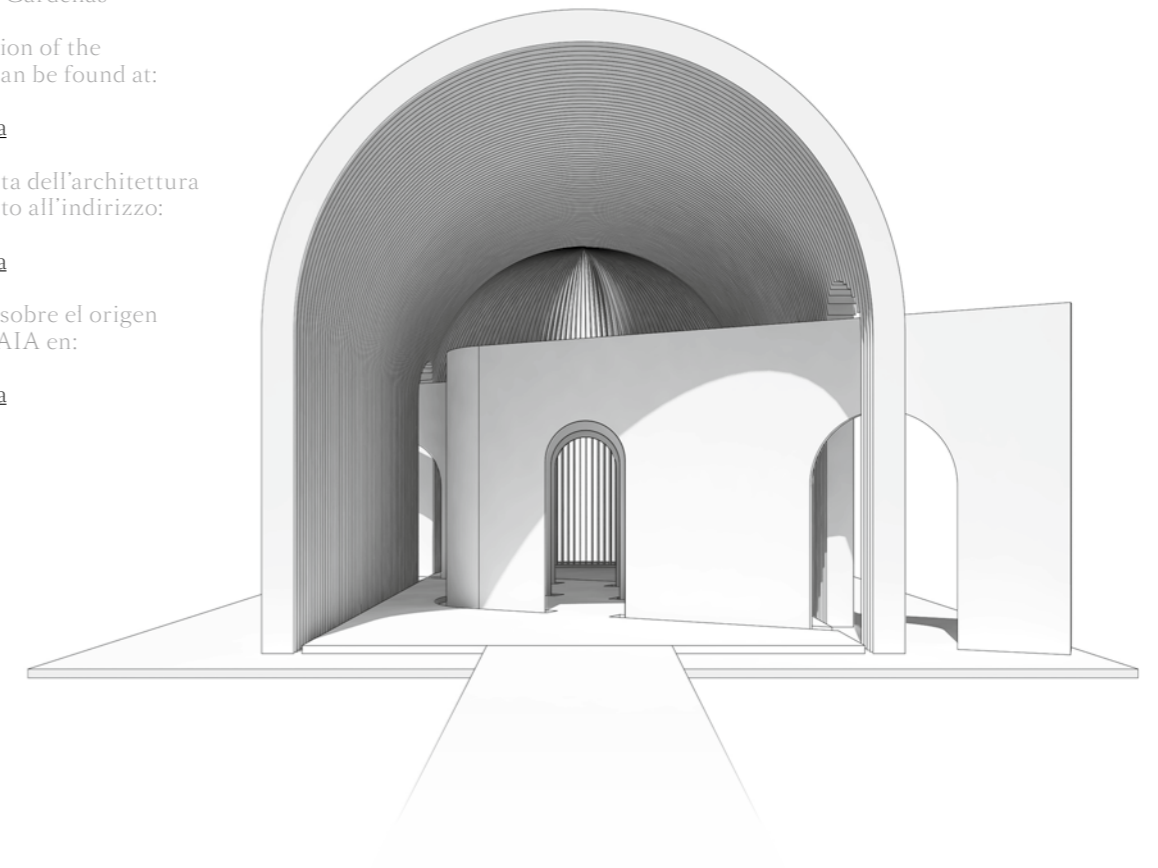

HEALING EFFECTS

p. NH-01

Inspired by the ideas of Neri & Hu.

EN Marble and concrete, brass and wood, natural light and platinum matt. The traditional Asian influences are as apparent here as the drive to create something new. A progressive and yet healing balance. The idea of Transitional Style leads to a meditation on space, texture and (bathroom) culture in the 21st century.

IT Marmo e cemento, ottone e legno, luce naturale e platino opaco. I tradizionali influssi asiatici son percepibili qui come un impulso verso la creazione di qualcosa di nuovo. Un equilibrio progressivo ma dall'effetto risanatore. L'idea Transitional Style diventa meditazione sullo spazio, la struttura e la cultura (del bagno) nel XXI^o secolo.

ES Mármol y hormigón, latón y madera, luz natural y platino mate. La influencia asiática tradicional es tan perceptible como el impulso de crear algo novedoso. Un equilibrio progresivo y terapéutico al mismo tiempo. La idea del Transitional Style se convierte en una meditación sobre el espacio, la textura y la cultura (del baño) en el siglo XXI.



INDEX

- 01 Oak Rovere Roble
- 02 Marble Marmo Mármol
- 03 Brass Ottone Latón
- 04 Concrete Cemento Hormigón
- 05 Screed Massetto Solado
- 06 Platinum matt Platino opaco Platino mate
- 07 New wool Lana vergine Lana de vellón
- 08 Ceramic Ceramica Cerámica





26

Marble, brass and platinum matt in front of a wall of raw concrete: the choice of materials shows how the existing can be progressively enhanced by combination with the new.

Il marmo, l'ottone e il platino opaco davanti ad una parete in cemento grezzo: la scelta dei materiali indica la progressiva valorizzazione dell'esistente mediante la combinazione con il nuovo.

Mármol, latón y platino mate frente a una pared de hormigón en bruto: la selección de materiales muestra cómo se puede revalorizar lo existente progresivamente mediante la combinación con lo nuevo.





normal persons
only please

evo

OSHO





32

The raw structure of the concrete highlights the natural grain of the wood and the finely polished platinum matt of the deck-mounted bath fitting.

La struttura grezza del cemento evidenzia la venatura del legno rispetto alla finitura del platino opaco levigato della rubinetteria al bordo vasca.

La estructura en bruto del hormigón resalta el veteado natural de la madera y el platino mate, rectificado finamente, de la grifería al borde de la bañera.



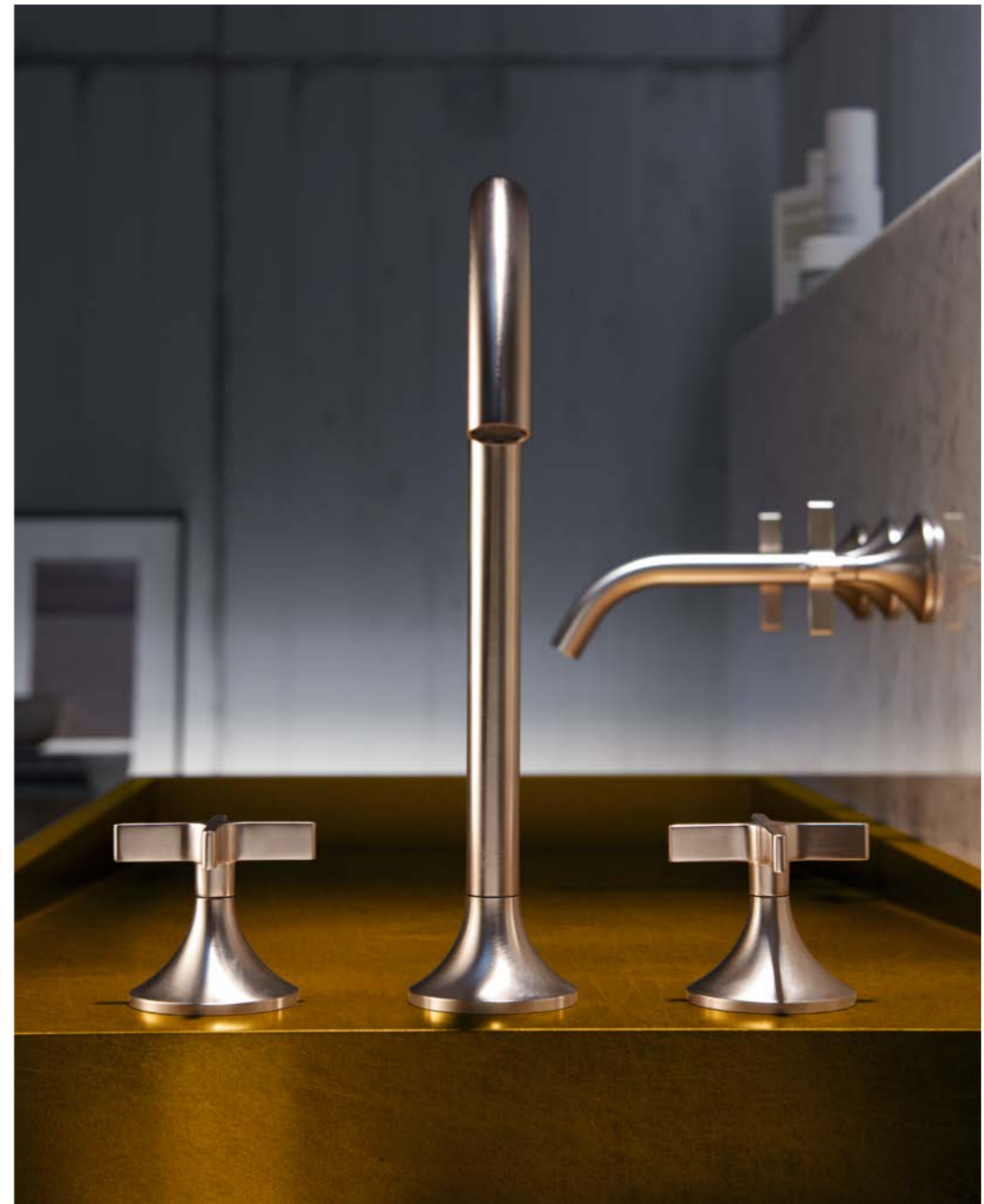

Between mind and matter: depending on the respective mood lighting, the different materials radiate a contemplative, almost mystical warmth.

Tra spirito e materia: a seconda della tonalità di luce i vari materiali riflettono un calore contemplativo e quasi mistico.

Entre lo espiritual y lo material: en función del ambiente luminoso, los diferentes materiales desprenden una calidez contemplativa, casi mística.



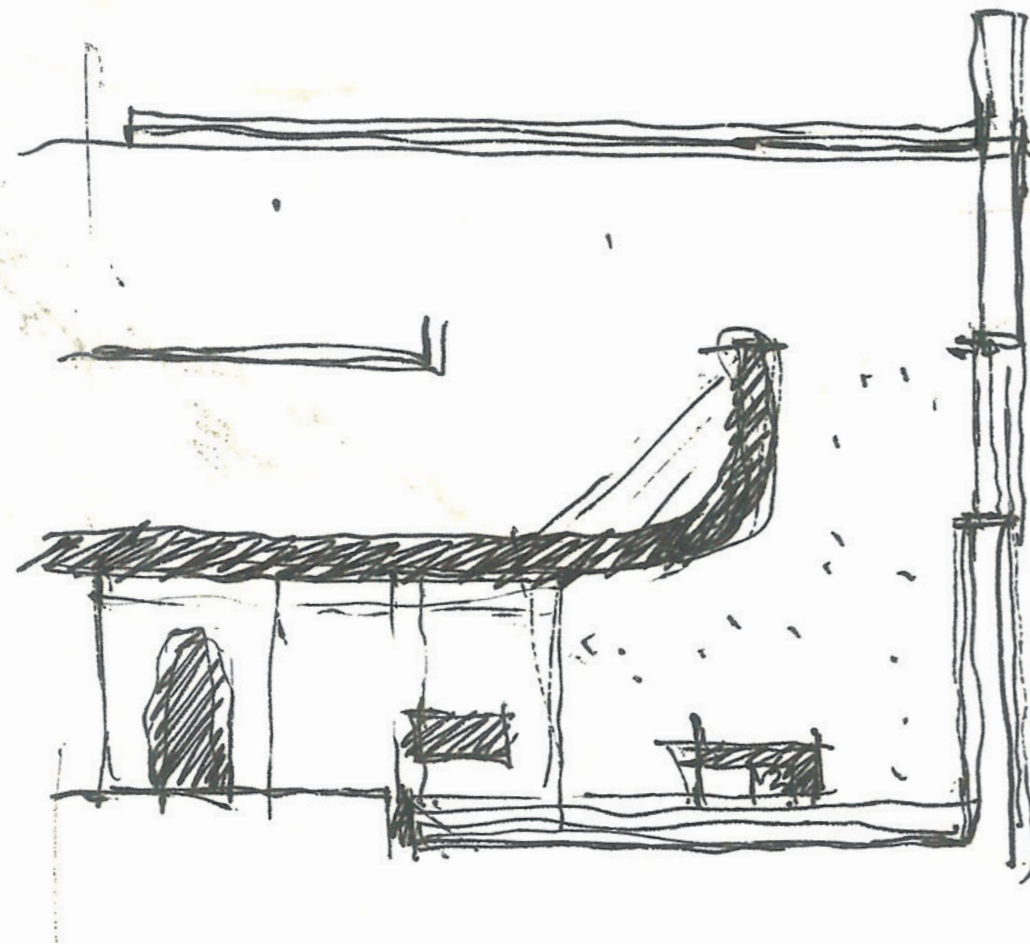

EN First and foremost, NERI & HU understand the idea of Transitional Style in terms of architecture: the bathroom as a room in which to linger a while, a room for regeneration, a source of energy and a place of transition. The washstand as a central, communicative meeting place. This gives rise to some important resonances for bathroom architecture.

IT NERI & HU intendono il concetto di Transitional Style soprattutto in senso architettonico: il bagno come luogo di pausa, di rigenerazione, fonte di energia, spazio di transizione. Il lavabo è un punto centrale, luogo per incontrarsi e di comunicazione. Ne derivano importanti citazioni per l'architettura del bagno.

ES NERI & HU entienden el concepto del Transitional Style sobre todo desde la arquitectura: el baño como un espacio en el que detenerse, en el que regenerarse, una fuente de energía, un lugar de transición. El lavabo como lugar central y comunicativo de encuentro. De aquí se pueden desprender referencias importantes para la arquitectura de baños.

TRANSITIONAL STYLE A draft by Neri & Hu

A video on the creation of the
VAIA architecture can be found at:

dornbracht.com/vaia

Il filmato sulla nascita dell'architettura
VAIA può essere visto all'indirizzo:

by
NERI & HU
DESIGN AND RESEARCH OFFICE
Shanghai

NERI & HU

“FOR US, WATER MEANS EMOTIONAL HEALING.”
Lyndon Neri

The Water
The COURTYARD
The Window
The LIGHT | THE SHADOW
The Tactile
The MATERIALITY



Lyndon Neri & Rossana Hu
NERI & HU, SHANGHAI

TRANSITIONAL STYLE
A draft by Neri & Hu

A video on the creation of the
VAIA architecture can be found at:

dornbracht.com/vaia

Il filmato sulla nascita dell'architettura
VAIA può essere visto all'indirizzo:

EN

"The 'COURTYARD HOUSE' is very much an introverted house, where you don't have an outside, you don't have a window, and all the LIGHT only comes in from the centre."

IT

"La casa 'COURTYARD HOUSE' (casa con atrio) è un luogo particolarmente rivolto all'interiorità, in cui non esiste l'esterno, mancano le finestre e la LUCE proviene solo dal centro."

ES

"La 'CASA PATIO' es prácticamente una casa introvertida en la que no existe un exterior; no tienes ventanas y toda la LUZ entra solo desde el centro."



TRANSITIONAL STYLE
A draft by Neri & Hu

A video on the creation of the
VAIA architecture can be found at:

dornbracht.com/vaia

Il filmato sulla nascita dell'architettura
VAIA può essere visto all'indirizzo:

The Courtyard
NERI & HU, SHANGHAI

EN

"The COURTYARD is the space that joins all the spaces together.
In Chinese we call it the 四合院 'Siheyuan', which is the 'COURTYARD HOUSE'."

IT

"L'ATRIO è lo spazio in cui confluiscono tutti gli ambienti.
In cinese lo chiamiamo 四合院 'Siheyuan', che significa 'CASA CON ATRIO'
o 'COURTYARD HOUSE'."

ES

"El PATIO es el espacio que une todos los demás espacios.
En chino lo llamamos el 四合院 'Siheyuan', que significa 'CASA PATIO'."



TRANSITIONAL STYLE
A draft by Neri & Hu

A video on the creation of the
VAIA architecture can be found at:

dornbracht.com/vaia

Il filmato sulla nascita dell'architettura
VAIA può essere visto all'indirizzo:



EN
“In Asia, water to us is not just something that is for drinking, it’s not just something for cleansing, for us, WATER means a lot of emotional healing and physical healing.”

IT
“Per noi asiatici l’acqua non è semplicemente ciò che beviamo o con cui ci laviamo, l’ACQUA ha una forte valenza emotiva perché apporta una guarigione emotiva e fisica.”

ES
“En Asia, el agua no es simplemente algo que beber, no es algo para limpiar; para nosotros, el AGUA tiene un significado de curación emocional y física.”

The Water
NERI & HU, SHANGHAI



EN

THE NOTION OF THE "TRANSITIONAL"

In this collaboration with DORNBRACHT we were challenged to consider the notion of the "TRANSITIONAL", not only STYLISTICALLY, but also CULTURALLY, SPATIALLY and MATERIALLY.

From the start, we knew we wanted to create an environment that embodies all of these aspects, so we envisioned a fictitious space, a house inhabited by two unique characters, the introvert and the extrovert.

The MUNDANE RITUALS of living are celebrated and elevated to A CEREMONIAL STATUS.

Bathing and cleansing become an emotional journey, a deep connection to both the INNER SELF and the OUTER WORLD.

Sleeping and studying, the most intimate moments of our day, the psychology of those acts manifests within the walls, openings, materials and details.

WITH THE CHOICE OF MATERIALS, THE NARRATIVE OF THE TRANSITIONAL UNFOLDS EVEN FURTHER.

There is an intentional juxtaposition of RAW VERSUS REFINED, COLD VERSUS WARM.

The feeling is as if inhabiting an existing rough shell of a structure, adding precious elements to enrich the experience.

But even more crucial is the INTERACTION OF THESE MATERIALS WITH THE ENVIRONMENT. The concrete, stone and metals – even water, which we consider a "building" material – are constantly changing with the light and the seasons.



LYNDON NERI & SENIOR ASSOCIATE LAURENT TEK

NH-08

TRANSITIONAL STYLE

A draft by Neri & Hu

A video on the creation of the VAIA architecture can be found at:

dornbracht.com/vaia

Il filmato sulla nascita dell'architettura VAIA può essere visto all'indirizzo:

IT

LA NOZIONE DI 'TRANSITIONAL'

In questa collaborazione con DORNBRACHT ci siamo cimentati in una riflessione sul concetto di 'TRANSIZIONALE', non solo sotto il profilo STILISTICO, ma anche CULTURALE, SPAZIALE e MATERIALE.

Sapevamo dall'inizio che volevamo creare un ambiente in cui concentrare tutti questi aspetti così abbiamo immaginato uno spazio fittizio, una casa abitata da due personalità uniche, l'introversa e l'estroversa.

I RITUALI MONDANI dell'abitare vengono celebrati ed elevati a STATO CERIMONIALE.

Il bagno e la purificazione diventano un viaggio emotivo, un legame profondo sia con L'INTERIORITÀ che con il MONDO ESTERNO.

Il sonno e lo studio, i momenti più intimi della giornata, la psicologia di quelle azioni si esprime tra le pareti, le aperture, i materiali e i particolari.

CON LA SCELTA DEI MATERIALI, IL RACCONTO DEL TRANSIZIONALE SI SVILUPPA ANCORA OLTRE.

C'è un'intenzionale contrapposizione tra GREZZO E RIFINITO, FREDDO E CALDO.

La sensazione che ne deriva è quella quasi di abitare nel guscio grezzo esistente di una struttura impreziosito da elementi di valore in grado di arricchire l'esperienza. Ma ancora più determinante è l'INTERAZIONE TRA QUESTI MATERIALI E L'AMBIENTE.

Il cemento, la pietra ed i metalli – anche l'acqua, da noi considerata un materiale "da costruzione" – sono continuamente trasformati dalla luce e dalle stagioni.



FIRST DRAFTS
PRIME BOZZE
PRIMEROS BOCETOS



LYNDON NERI

NH-09

ES

LA NOCIÓN DE LO 'TRANSITIONAL'

En esta colaboración con DORNBRACHT se nos desafió a considerar la noción de lo 'TRANSITIONAL', no solo en cuanto a ESTILO, sino también en cuanto a CULTURA, ESPACIO y MATERIALES.

Desde el principio supimos que queríamos crear un entorno que encarnara todos estos aspectos, así que concebimos un espacio ficticio, una casa habitada por dos personajes singulares: el introvertido y el extrovertido.

Los RITUALES MUNDANOS de la vida se celebran y se elevan a una POSICIÓN CEREMONIAL.

El baño y la limpieza se convierten en un viaje emocional, una conexión profunda tanto con el YO INTERIOR como con el MUNDO EXTERIOR. El sueño y el estudio, los momentos más íntimos de nuestro día; la psicología de estos actos se manifiesta en las paredes, las aperturas, los materiales y los detalles.

CON LA SELECCIÓN DE MATERIALES, LA NARRATIVA TRANSITORIA SE DESPLIEGA AÚN MÁS.

Existe una yuxtaposición intencionada de LO BRUTO CON LO REFINADO, LO FRÍO CON LO CÁLIDO.

La sensación es la de habitar dentro del cascarón áspero de una estructura a la que se le han añadido valiosos elementos para enriquecer la experiencia. Pero aún más crucial es la INTERACCIÓN DE ESTOS MATERIALES CON EL ENTORNO.

El hormigón, la piedra y los metales (incluso el agua, que consideramos un material de "construcción") cambian constantemente con la luz y las estaciones.



ROSSANA HU & LYNDON NERI

NH-10

TRANSITIONAL STYLE

A draft by Neri & Hu

A video on the creation of the VAIA architecture can be found at:

dornbracht.com/vaia

Il filmato sulla nascita dell'architettura VAIA può essere visto all'indirizzo:

EN

A B O U T

Neri & Hu

Founded in 2004 by partners Lyndon Neri and Rossana Hu, NERI & HU DESIGN AND RESEARCH OFFICE is an interdisciplinary architectural design practice based in Shanghai, China, with an additional office in London, UK. NERI & HU works internationally providing architecture, interior, master planning, graphic and product design services.

NERI & HU believes strongly in research as a design tool, as each project bears its unique set of contextual issues. A critical probing into the specificities of programme, site, function and history is essential to the creation of rigorous design work. Based on research, NERI & HU desires to anchor its work in the dynamic interaction of experience, detail, material, form and light, rather than conforming to a formulaic style. The ultimate significance behind each project comes from how the built forms create meaning through their physical representations.

IT

A B O U T

Neri & Hu

Creato nel 2004 dai soci Lyndon Neri e Rossana Hu, NERI & HU DESIGN AND RESEARCH OFFICE è uno studio interdisciplinare d'architettura con sede a Shanghai, Cina, ed una succursale a Londra, Regno Unito. Lo studio NERI & HU lavora a livello internazionale a progetti d'architettura, interni, pianificazione generale, grafica e servizi di design di prodotti.

NERI & HU crede fermamente nella ricerca come strumento al servizio del design in cui ciascun progetto è caratterizzato da una serie unica di elementi contestuali. La verifica critica nella

specificità di programmi, del luogo, della funzione e della storia è fondamentale per la creazione di un lavoro rigoroso di design. Partendo dalla ricerca NERI & HU si propone di agganciare il proprio lavoro all'interazione dinamica tra esperienza, dettagli, materiali, forma e luce invece di adattarsi a formule apprese. Il significato finale dentro ad ogni progetto è la creazione di significati partendo da forme costruite mediante le loro rappresentazioni fisiche.

ES

A B O U T

Neri & Hu

Fundada en 2004 por los socios Lyndon Neri y Rossana Hu, NERI & HU DESIGN AND RESEARCH OFFICE es un despacho de diseño arquitectónico multidisciplinar con sede en Shanghái, China, con una oficina adicional en Londres, Reino Unido. NERI & HU trabaja a nivel internacional para proporcionar servicios de arquitectura, interiorismo, planificación maestra, gráficos y diseño de productos.

NERI & HU cree con vehemencia en la investigación como herramienta de diseño, en tanto que cada proyecto implica su propia y singular escena contextual. Una exploración crítica de las especificaciones del programa, la ubicación, la función y la historia es esencial para crear un trabajo de diseño riguroso. Con la investigación como fundamento, NERI & HU desea anclar su trabajo en la interacción dinámica de la experiencia, los detalles, los materiales, la forma y la luz en lugar de conformarse con un estilo predispuesto. El significado definitivo de cada proyecto resulta de cómo las formas construidas crean un sentido a través de sus representaciones físicas.

NERI & HU
DESIGN AND RESEARCH OFFICE
SHANGHAI

neriandhu.com

EN

“So this whole, seemingly transitional space might be irrelevant in many cultures, but in Asia, we perceive water, the courtyard and in the end, the notion of life, in a very different way.”

IT

“Questo spazio apparentemente transizionale nella sua globalità può sembrare irrilevante in molte culture ma per noi sia l’acqua che l’atrio ed, in ultima analisi, l’idea della vita appaiono in una prospettiva molto diversa in Asia.”

ES

“Así pues, todo este espacio aparentemente transitorio puede resultar irrelevante en muchas culturas; pero nosotros, en Asia, el agua, el patio y al final la noción de la vida los vemos de forma completamente diferente.”

Lyndon Neri



TRANSITIONAL STYLE

A draft by Neri & Hu

A video on the creation of the VAIA architecture can be found at:

dornbracht.com/vaia

Il filmato sulla nascita dell'architettura VAIA può essere visto all'indirizzo:

dornbracht.com/vaia

Encontrará el vídeo sobre el origen de la arquitectura VAIA en:

dornbracht.com/vaia

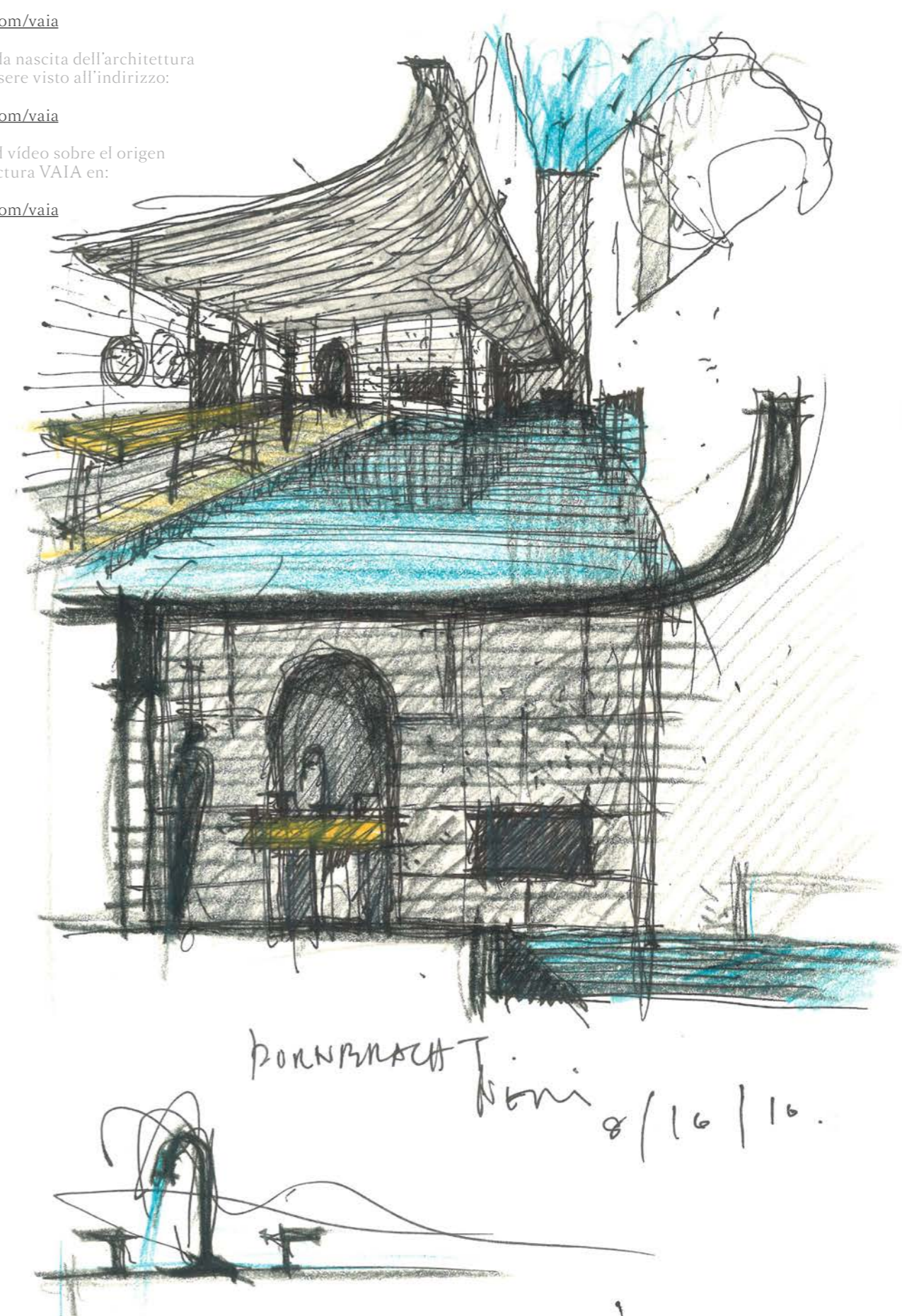



Dornbracht VAIA
Create a new balance

EN How do you design an interior worthy of the designation "transitional"? Using which materials, colours and shapes? And how can the balancing act between traditional and contemporary resonances be combined with new, individual ideas? Rafael de Cárdenas and Lyndon Neri have found highly impressive, innovative answers to these questions. The material collages on this and the following pages are two additional examples. They underline once more the versatile and progressive elegance with which VAIA fits into very different furnishing styles. However, they just provide inspiration: the way in which you interpret Transitional Style, how and where you use VAIA, in which variant and in conjunction with which materials and colours remains, of course, completely dependent on your creativity and your intuition.

#createanewbalance

TON SUR TON

EN The "Ton sur Ton" collage describes an elegant, neutral world with a subtle colour palette and finely combined material textures. Marble, with its brownish tint and large grain, reflects classic elements, while concrete and DARK PLATINUM MATT bridge the gap to modernity.

IT Il collage "Ton sur Ton" descrive un mondo elegante e neutrale con una raffinata palette di colori e strutture di materiali abbinata con raffinatezza. Il marmo con le sue tonalità marroni e le grandi venature cita elementi classici mentre il cemento e il DARK PLATINUM MATT conferiscono toni di modernità.

ES El collage "Ton sur Ton" describe un mundo elegante y neutro con una paleta de colores sutil y con texturas de materiales delicadamente combinadas. El mármol, con su tono parduzco y gran veteado, invoca los elementos clásicos, mientras que el hormigón y el DARK PLATINUM MATT crean un puente hacia la modernidad.

CREATE A NEW BALANCE

IT Come si progetta un interno che può essere definito come "transitional"? Con quali materiali, colori e forme? Come si concilia l'equilibrio tra citazioni tradizionali e contemporanee con idee nuove e personali? Rafael de Cárdenas e Lyndon Neri hanno risposto a queste domande in modo sorprendente ed innovativo. I collage di materiali di questa e della seguente pagina ne sono due ulteriori esempi. Ancora una volta sottolineano la variegata e progressiva eleganza con cui VAIA s'inserisce in stili di arredamento molto diversi.

INDEX

- 01 Fabric Tessuto Tejidos
- 02 Marble Marmo Mármol
- 03 Smoked glass Vetro brunito Cristal ahumado
- 04 Copper Rame Cobre
- 05 Concrete Cemento Hormigón
- 06 Cherry wood Ciliegio Cerezo
- 07 Dark Platinum Matt
- 08 Marble Marmo Mármol
- 09 Walnut Noce Nogal
- 10 High pile shag Tappeto shag a pelo lungo Alfombra de pelo largo

La finalità è solamente quella di essere fonte d'ispirazione concettuale: in che modo s'interpreta il Transitional Style, come e dove utilizzare VAIA, in quali varianti e con quale interazione tra materiali e colori dipende invece esclusivamente dalla vostra creatività ed intuizione.

#createanewbalance

ES ¿Cómo se diseña un interior que merezca la denominación "transitional"? ¿Con qué materiales, colores y formas? ¿Y cómo se pueden equilibrar sentencias tradicionales y contemporáneas con ideas nuevas e individuales? Rafael de Cárdenas y Lyndon Neri han encontrado respuestas innovadoras e impresionantes para estas preguntas. Los collages de materiales en

esta página y la siguiente son dos ejemplos adicionales. Destacan una vez más la elegancia polifacética y progresiva con la que VAIA se integra en los más diversos estilos de mobiliario. Al final es solo una inspiración: de qué modo interprete el Transitional Style, cómo y dónde instale VAIA, en qué variante y en combinación con qué materiales y colores... todo queda, por supuesto, en manos de su creatividad y su intuición.

#createanewbalance

MULTITUDE

EN "Multitude" is a fresh, curious look at Transitional Style: various white textures (matt/glossy), platinum matt in combination with blue and green tones. Here, soft velvet and mosaic tiles embody the more classic element, with the fresh colours and matt white surfaces providing the contemporary counterpart.

IT "Multitude" è uno sguardo fresco e curioso verso il Transitional Style: diversi tipi di struttura bianca (opaca/lucida), platino opaco abbinato a tonalità dell'azzurro e del verde. Morbido velluto e mosaico interpretano qui una visione piuttosto classica, i colori freschi e le superfici bianche opache ne rappresentano la controparte contemporanea.

ES "Multitude" es una visión fresca y curiosa del Transitional Style: diferentes texturas blancas (mate/brillante), platino mate en combinación con tonos azules y verdes. El terciopelo suave y las baldosas de mosaicos dan forma a la parte más bien clásica; los colores frescos y las superficies blancas mate, a su contraparte contemporánea.



INDEX

- | | |
|--|--|
| 01 Linen Lino Lino | 07 High pile shag Tappeto shag a pelo lungo Alfombra de pelo largo |
| 02 Wallpaper Carta da parati Papel pintado | 08 Velvet Velluto Terciopelo |
| 03 Ceramic Ceramica Cerámica | 09 Marble Marmo Mármol |
| 04 Plaster Gesso Revoque de yeso | 10 Platinum matt Platino opaco Platino mate |
| 05 Concrete Cemento Hormigón | 11 Limestone Pietra calcarea Caliza |
| 06 Cement mosaic tile Piastrella a mosaico in cemento Baldosa de mosaicos de cemento | 12 Enamel Smalto Esmalte |



VAIA

EN VAIA is as delicate as it is forward-looking. This series of fittings embodies a soft, balanced design language and an attitude which is always open to what is new. An elegant, progressive design for a new iconography of the modern age.

IT VAIA è caratterizzata da un design filigranato e allo stesso tempo progressivo. La serie di rubinetterie presenta forme morbide ed equilibrate ed un particolare gusto per la novità. Un design elegante e progressivo per una nuova iconografia del moderno.

ES VAIA es tanto afiligranado como progresista. La serie de griferías da vida a un lenguaje de formas suave y equilibrado, y a una posición fundamental que siempre queda abierta a la novedad. Un diseño elegante y progresivo para una nueva iconografía de modernidad.

EN A characteristic feature of VAIA are the soft radii, the fine silhouette and the flowing transitions. The conical rosettes appear to almost merge with the washstand. However, this leaves everything in perfect proportion.

IT Caratteristici di VAIA sono i morbidi raggi, la linea slanciata e i passaggi fluidi. Le rosette coniche sembrano quasi fondersi con il piano del lavabo. Tutte le proporzioni sono in perfetta sintonia reciproca.

ES Son característicos de VAIA los radios suaves, las siluetas refinadas y las transiciones fluidas. Es casi como si las rosetas cónicas se fundiesen con el lavabo. Y al hacerlo, todo se encuentra perfectamente proporcionado.





48

EN Precision craftsmanship down to the last detail: meticulously defined joints and an integrated aerator hidden in the spout that only gets noticed when the water flows.

IT Lavorazione precisa fin nei dettagli: fughe delineate con precisione ed un rompigitto integrato nella bocca di erogazione visibile solo quando l'acqua scorre.

ES Acabado preciso hasta el último detalle: ranuras definidas con exactitud y un difusor integrado oculto en el caño que solo se percibe cuando el agua fluye.



EN The clear-cut lines, the delicate shapes: VAIA is a fitting with a strong personality. Despite this – or for exactly this reason – the design merges smoothly into the range of contemporary furnishing styles.

IT Le linee nette, le forme filigranate: VAIA è una rubinetteria di forte personalità. Eppure – o proprio per questo – il design s'inserisce con eleganza nei più svariati stili attuali di arredamento.

ES Las líneas claras, las formas afiligranadas: VAIA es una grifería con personalidad. Aun así, o precisamente por esto, el diseño se integra de forma elegante en la multitud de estilos actuales.





DARK PLATINUM MATT

EN DARK PLATINUM MATT is a dark, silk matt tone with a fine brush stroke, which radiates warmth and originality. The surface fits harmoniously into a somewhat dark bathroom interior or enables exciting contrasts in a bright architectural environment.

IT DARK PLATINUM MATT è una tonalità scura e satinata con spazzolate sottili che comunica calore e natura primordiale. La superficie s'inserisce in modo armonioso in un bagno piuttosto scuro oppure consente di creare vivaci contrasti in un contesto architettonico chiaro.

ES El DARK PLATINUM MATT es un tono oscuro satinado con un fino cepillado que irradia calidez y originalidad. La superficie se integra armónicamente en un interior de baño más bien oscuro o permite fascinantes contrastes en un entorno arquitectónico claro.

Product Information

Informazioni sui prodotti

Información de producto

Excerpt from the product range.
More detailed information can be obtained from your dealer.

Estratto dalla gamma completa prodotti.
Il Vostro rivenditore specializzato sarà lieto di fornirvi maggiori informazioni.

Extracto del programa de productos.
Su comercio le facilitará informaciones exhaustivas.

[x l/min. / x gpm]

indicates the maximum flow rate at 3 bar.
indica la portata massima a 3 bar.
representa el caudal máximo a 3 bar.

Finishes
Superfici
Superficies



00

polished chrome
cromato
cromo

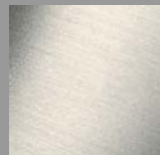

06

platinum matt
platinato opaco
platino mate

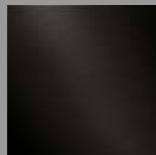

99

Dark Platinum matt

Due to the printing technique used here,
the colours shown above may vary from the
true colour of the actual finish.

Per motivi tecnici di stampa non possiamo
garantire la fedeltà dei colori qui riprodotti.

Los colores reproducidos en el presente
catálogo no son vinculantes por razones de
impresión.

Basin Lavabo Lavabo



33 500 809 / 33 521 809

Single-lever basin mixer with/
without pop-up waste, 167 mm
projection

Miscelatore monocomando
lavabo con/senza piletta,
sporgenza 167 mm

Monomando de lavabo con/
sin válvula automática,
saliente 167 mm

[5,7 l/min.]
[USA: 5.7 l/min. / 1.2 gpm]



33 510 809 / 33 525 809

Single-lever basin mixer with/
without pop-up waste, 123 mm
projection

Miscelatore monocomando
lavabo con/senza piletta,
sporgenza 123 mm

Monomando de lavabo con/
sin válvula automática,
saliente 123 mm

[5,7 l/min.]
[USA: 5.7 l/min. / 1.2 gpm]



33 533 809 / 33 534 809

Single-lever basin mixer with/
without pop-up waste, 201 mm
projection

Miscelatore monocomando
lavabo con/senza piletta,
sporgenza 201 mm

Monomando de lavabo con/
sin válvula automática,
saliente 201 mm

[5,7 l/min.]
[USA: 5.7 l/min. / 1.2 gpm]



20 713 809

Three-hole basin mixer with
pop-up waste, 168 mm projection

Batteria tre fori lavabo con piletta,
sporgenza 168 mm

Batería americana de lavabo
con válvula automática,
saliente 168 mm

[5,7 l/min.]
[USA: 5.7 l/min. / 1.2 gpm]



20 713 819

Three-hole basin mixer with
pop-up waste, 168 mm projection

Batteria tre fori lavabo con piletta,
sporgenza 168 mm

Batería americana de lavabo
con válvula automática,
saliente 168 mm

[5,7 l/min.]
[USA: 5.7 l/min. / 1.2 gpm]



36 812 809

Wall-mounted single-lever
basin mixer with pop-up waste,
190 mm projection

Miscelatore monocomando
lavabo incasso con piletta,
sporgenza 190 mm

Batería monomando empotrada
para lavabo con válvula automática,
saliente 190 mm

[5,7 l/min.]
[USA: 5.7 l/min. / 1.2 gpm]



36 712 809

Wall-mounted basin mixer without
pop-up waste, 190 mm projection

Tre fori incasso a muro senza
piletta, sporgenza 190 mm

Batería de pared para lavabo sin
válvula automática, saliente 190 mm

[5,7 l/min.]
[USA: 5.7 l/min. / 1.2 gpm]



36 712 819

Wall-mounted basin mixer without
pop-up waste, 190 mm projection

Tre fori incasso a muro senza
piletta, sporgenza 190 mm

Batería de pared para lavabo sin
válvula automática, saliente 190 mm

[5,7 l/min.]
[USA: 5.7 l/min. / 1.2 gpm]



13 716 809*

Deck-mounted basin spout without
pop-up waste, 168 mm

Bocca verticale lavabo senza
piletta, sporgenza 168 mm

Salida vertical para lavabo sin
válvula automática, saliente 168 mm

[5,7 l/min.]
[USA: 5.7 l/min. / 1.2 gpm]



13 800 809*

Wall-mounted basin spout,
190 mm projection

Bocca lavabo incasso,
sporgenza 190 mm

Salida a pared de lavabo,
saliente 190 mm

[5,7 l/min.]
[USA: 5.7 l/min. / 1.2 gpm]

* Particularly suitable for use with the Touchfree system. You can find further information at: dornbracht.com/touchfree / Adatta in particolare per l'uso con il sistema Touchfree. Potete trovare ulteriori informazioni sotto www.dornbracht.com/touchfree / Especialmente apropiado para su aplicación con el sistema Touchfree. Encontrará más información en: www.dornbracht.com/touchfree

Bidet



33 600 809

Single-lever bidet mixer

Miscelatore monocomando bidet

Monomando bidet

[5,7 l/min.]
[USA: 5.7 l/min. / 1.2 gpm]

Shower Doccia Ducha



28 699 970* / 28 689 970 /
28 669 970

Shower to fix under the ceiling,
Ø 400/300/220 mm

Soffione a pioggia con fissaggio
a soffitto, Ø 400/300/220 mm

Ducha de lluvia con fijación a plafón,
Ø 400/300/220 mm

[14 l/min. / 14 l/min. / 9 l/min.]
[USA: 7.6 l/min. / 2 gpm]



28 659 970* / 28 679 970 /
28 649 970

Shower with wall fixing,
Ø 400/300/220 mm

Soffione a pioggia con fissaggio
a muro, Ø 400/300/220 mm

Ducha de lluvia con fijación a pared,
Ø 400/300/220 mm

[14 l/min. / 14 l/min. / 9 l/min.]
[USA: 7.6 l/min. / 2 gpm]



28 504 979

Shower head

Doccia testa

Ducha fija

[7 l/min.]
[USA: 7 l/min. / 1.85 gpm]



28 518 979 / 28 519 979

Body spray without/with volume
control

Soffione laterale senza/con
regolazione di portata dell'acqua

Ducha lateral de masaje articulada
sin/con regulación de cauda

[5/8 l/min.]
[USA: 5/8 l/min. / 1.3/2 gpm]



26 403 809

Complete shower set

Gruppo doccia con flessibile
e asta saliscendi

Juego de ducha de mano con
barra corredera

[7,6 l/min.]
[USA: 7.6 l/min. / 2 gpm]

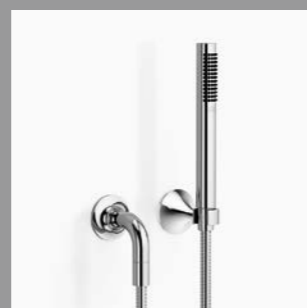

27 808 809

Complete hand shower set

Gruppo doccia con flessibile
a muro

Juego de ducha de mano con
codo de conexión a pared

[7,5 l/min.]
[USA: 7.5 l/min. / 2 gpm]



36 416 979 + 3x 36 310 809 /
+ 2x 36 310 809 /
+ 1x 36 310 809

xTOOL thermostat module with
3 valves/2 valves/1 valve

xTOOL modulo termostato con
3 rubinetti/2 rubinetti/1 rubinetto

Módulo de termostato xTOOL con
3 válvulas/2 válvulas/1 válvula



36 416 979 + 3x 36 310 819 /
+ 2x 36 310 819 /
+ 1x 36 310 819

xTOOL thermostat module with
3 valves/2 valves/1 valve

xTOOL modulo termostato con
3 rubinetti/2 rubinetti/1 rubinetto

Módulo de termostato xTOOL con
3 válvulas/2 válvulas/1 válvula



36 120 809* / 36 020 809*

Concealed single-lever mixer
with/without diverter

Miscelatore monocomando
incasso con/senza deviatore

Batería monomando empotrada
con/sin inversor



36 427 970 / 36 426 970 /
36 425 970

Concealed thermostat with three/
two/one function volume control

Termostato incasso con
regolazione di portata dell'acqua
a tre vie/a due vie/ad una via

Termostato empotrado con
regulación de caudal de tres vías/
dos vías/una vía



26 100 809

Wall-mounted shower mixer

Gruppo doccia esterno

Batería bimando de ducha para
montaje a pared



26 100 819

Wall-mounted shower mixer

Gruppo doccia esterno

Batería bimando de ducha para
montaje a pared



34 440 979 + 11 430 979

3/8" wall-mounted shower
thermostat

Termostato doccia esterno 3/8"

Termostato de ducha 3/8" para
montaje a pared

Bath Vasca Bañera

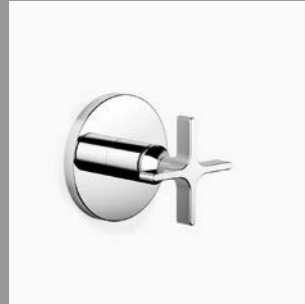

36 104 809

Concealed two- and three-way diverter

Deviatore a due/tre vie da incasso
Inversor empotrado de dos/tres vías



36 104 819

Concealed two- and three-way diverter

Deviatore a due/tre vie da incasso
Inversor empotrado de dos/tres vías



36 310 809

Wall valve
Rubinetto incasso
Llave de paso



36 310 819

Wall valve
Rubinetto incasso
Llave de paso



25 133 809 / 25 100 809

Wall-mounted bath mixer with/without shower set

Gruppo vasca esterno con/senza doccia
Batería para bañera/ducha, montaje a pared, con/sin ducha de mano

[7,6 l/min]*
[USA: 7.6 l/min. / 2 gpm]



25 133 819 / 25 100 819

Wall-mounted bath mixer with/without shower set

Gruppo vasca esterno con/senza doccia
Batería para bañera/ducha, montaje a pared, con/sin ducha de mano

[7,6 l/min]*
[USA: 7.6 l/min. / 2 gpm]

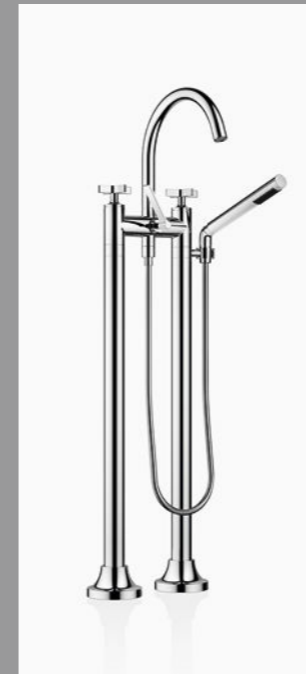

25 943 809

Two-hole bath mixer with stand feet
Gruppo vasca due fori e tubi verticali
Batería de bañera a dos orificios con tubos verticales

[7,6 l/min]*
[USA: 7.6 l/min. / 2 gpm]



25 943 819

Two-hole bath mixer with stand feet
Gruppo vasca due fori e tubi verticali
Batería de bañera a dos orificios con tubos verticales

[7,6 l/min]*
[USA: 7.6 l/min. / 2 gpm]



27 522 809

Deck-mounted bath set with hand shower set
Gruppo vasca cinque fori per montaggio bordo vasca
Batería de bañera de cinco orificios para montaje a borde de bañera

[7,6 l/min]*
[USA: 7.6 l/min. / 2 gpm]



27 522 819

Deck-mounted bath set with hand shower set
Gruppo vasca cinque fori per montaggio bordo vasca
Batería de bañera de cinco orificios para montaje a borde de bañera

[7,6 l/min]*
[USA: 7.6 l/min. / 2 gpm]

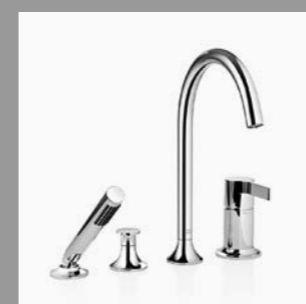

27 532 809

Deck-mounted bath mixer with hand shower set
Gruppo vasca quattro fori con miscelatore monocomando per montaggio su bordo vasca

Batería monomando de cuatro orificios para montaje a borde de bañera

[7,6 l/min]*
[USA: 7.6 l/min. / 2 gpm]



13 612 809

Bath spout without diverter
Bocca vasca senza deviatore
Caño de bañera sin conmutación

[22 l/min.]
[USA: 22 l/min. / 5.8 gpm]

*Flow-rate hand shower. / Portata doccia. / Caudal ducha de mano.

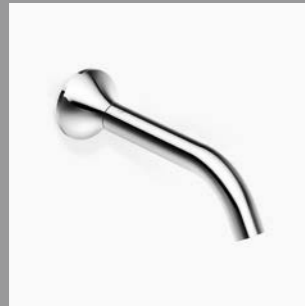

13 801 809
1/2" wall-mounted bath spout
Bocca vasca montaggio a muro 1/2"
Caño de bañera a pared 1/2"
[25,2 l/min.]
[USA: 25.2 l/min. / 6.7 gpm]



29 220 809
Single-lever bath mixer for bath rim installation
Miscelatore monocomando vasca per montaggio bordo vasca
Monomando de bañera para montaje a borde de bañera
[27,2 l/min.]
[USA: 27.2 l/min. / 7.2 gpm]

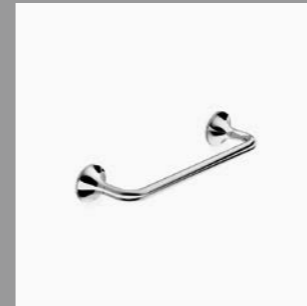

83 030 809
Bath grip, 300 mm
Maniglia d'appoggio, 300 mm
Barra para bañera, 300 mm



83 060 809
Towel bar, 660 mm
Asta portasciugamani, 660 mm
Barra para toallas de baño, 660 mm



20 000 819 / 20 000 818
Deck valve, anti-clockwise closing (cold)/clockwise closing (hot)
Rubinetto laterale con chiusura a sinistra (fredda)/a destra (calda)
Válvula lateral, cierre a izquierda (fría)/cierre a derecha (caliente)



20 000 809 / 20 000 808
Deck valve, clockwise closing (cold/hot)
Rubinetto laterale con chiusura a destra (fredda/calda)
Válvula lateral, cierre a derecha (fría/caliente)



83 211 809
1 arm towel bar, non-swivel
Portasciugamani singolo, fisso
Horquilla para toallas de mano, rígida

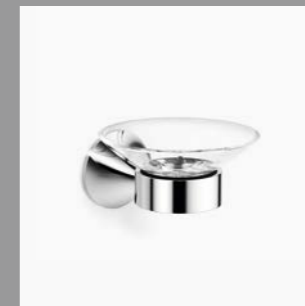

83 410 809
Soap dish wall model, complete
Portasaponetta modello da parete, completo
Jabonera modelo para colocar en la pared, completo

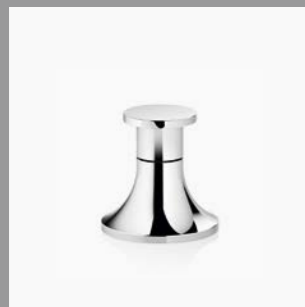

29 140 809
Two-way deck-mounted diverter
Deviatore a due vie bordo vasca
Inversor de dos vías para montaje a borde de bañera



34 525 979
Deck-mounted thermostat
Termostato per montaggio verticale
Termostato para montaje vertical

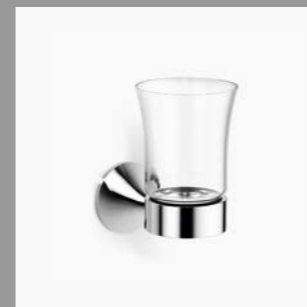

83 400 809
Tumbler holder wall model, complete
Portabicchiere modello da parete, completo
Soporte para vaso modelo para colocar en la pared, completo



83 510 809
Tissue holder with cover
Portarotolo con coprirotolo
Portarrollos con tapa



27 702 809
Deck-mounted shower assembly
Gruppo doccia con flessibile montaggio bordo vasca
Juego de manguera para ducha, montaje a borde de bañera
[7,6 l/min.]
[USA: 7.6 l/min. / 2 gpm]

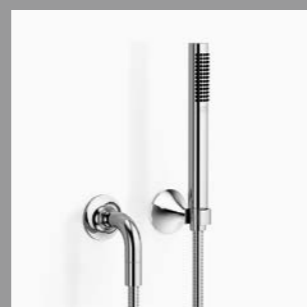

27 808 809
Complete hand shower set
Gruppo doccia con flessibile a muro
Juego de ducha de mano con codo de conexión a pared
[7,5 l/min.]
[USA: 7.5 l/min. / 2 gpm]



84 430 970 / 83 430 970
Lotion dispenser free-standing/wall model, complete
Dispenser per sapone modello da appoggio/da parete, completo
Dosificador de loción completo, modelo de colocación independiente/ de pared

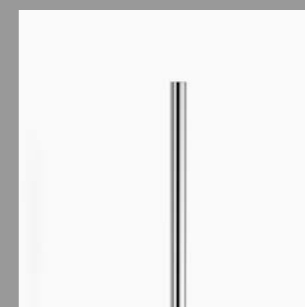

83 900 809
Toilet brush set wall model, complete
Portaspazzola WC con spazzola modello da parete, completo
Juego de cepillo para WC completo, para colocar en la pared



36 120 809* / 36 020 809*
Concealed single-lever mixer with/without diverter
Miscelatore monocomando incasso con/ senza deviatore
Batería monomando empotrada con/ sin inversor

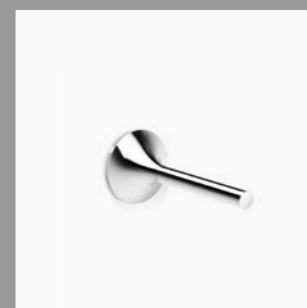

83 590 809
Reserve tissue holder
Portarotolo di riserva
Soporte para papel higiénico de reserva



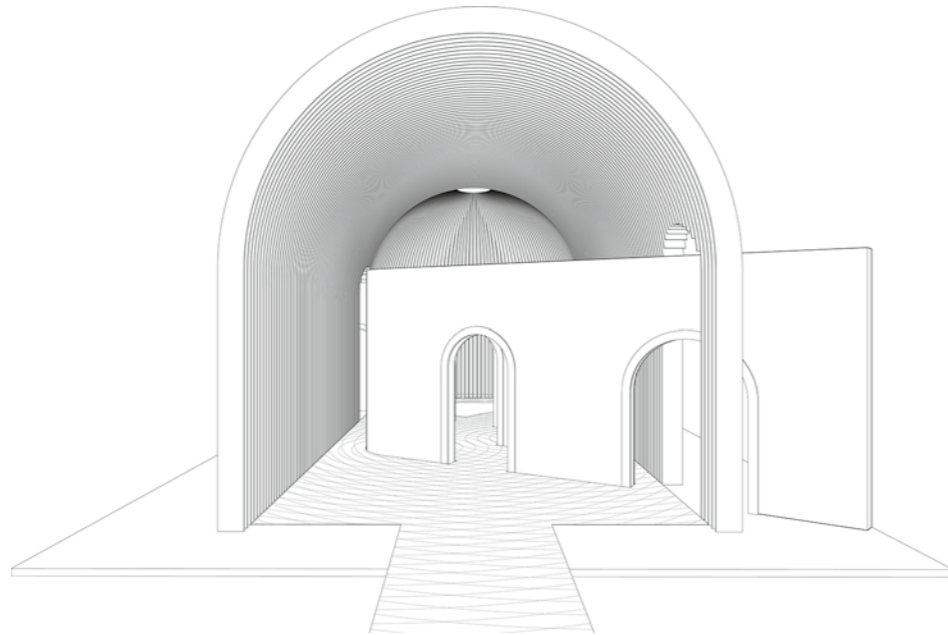

ARCHITECTURE
Rafael de Cárdenas
p. 04

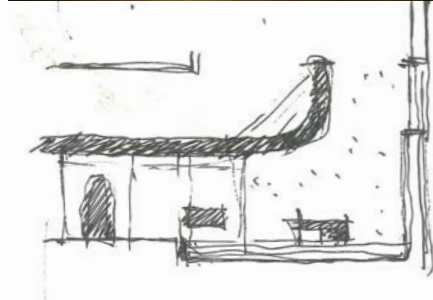

ARCHITECTURE
Neri & Hu
p. 22

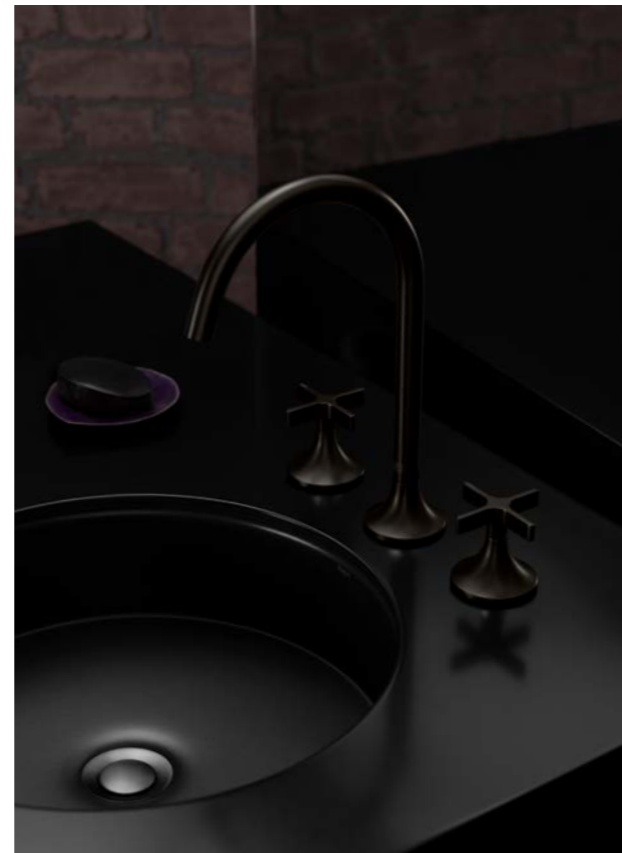

Product Design: Sieger Design Photography: Thomas Popinger
Concept and Creation: Meiré und Meiré Architecture: Rafael de Cárdenas and Neri & Hu

We reserve the right to implement model, program or technical modifications without prior notice.
Con riserva di errore e di modifiche tecniche, di modifiche ai modelli e alla gamma prodotti.
Nos reservamos el derecho a modificar modelos o colecciones, así como a realizar modificaciones de carácter técnico, y a haber incurrido en errores.

DORN
BRACHT

EN Innovation emerges at the interface.
The result of thoughtful overstepping
and skilful combination.

IT Oltrepassare i limiti per creare
qualcosa di nuovo. Con eccessi attenti
e combinazioni collaudate.

ES La innovación emerge en los puntos
de contacto. El resultado de un traspaso
atento y una habilidosa combinación.

Dornbracht VAIA
Create a new balance

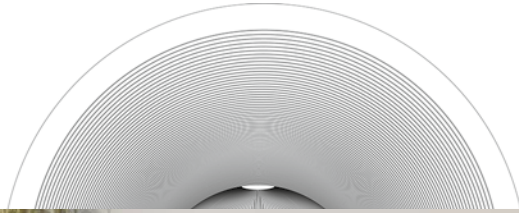

Dornbracht Americas Inc.
1700 Executive Drive South, Suite 600, Duluth, GA 30096
Phone 800-774-1181, Fax 800-899-8527
dornbrachtam@dornbrachtgroup.com, dornbracht.com

Dornbracht Group
Premium Solutions for Interior Architecture

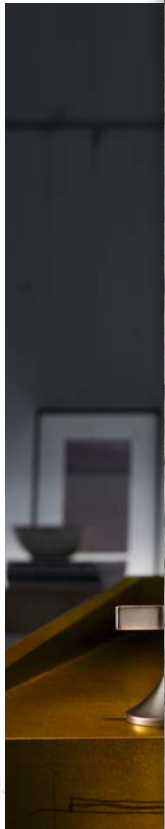

dornbracht.com/vaia

01 33 17 809 18