

ELEMENTS IN JAZZ

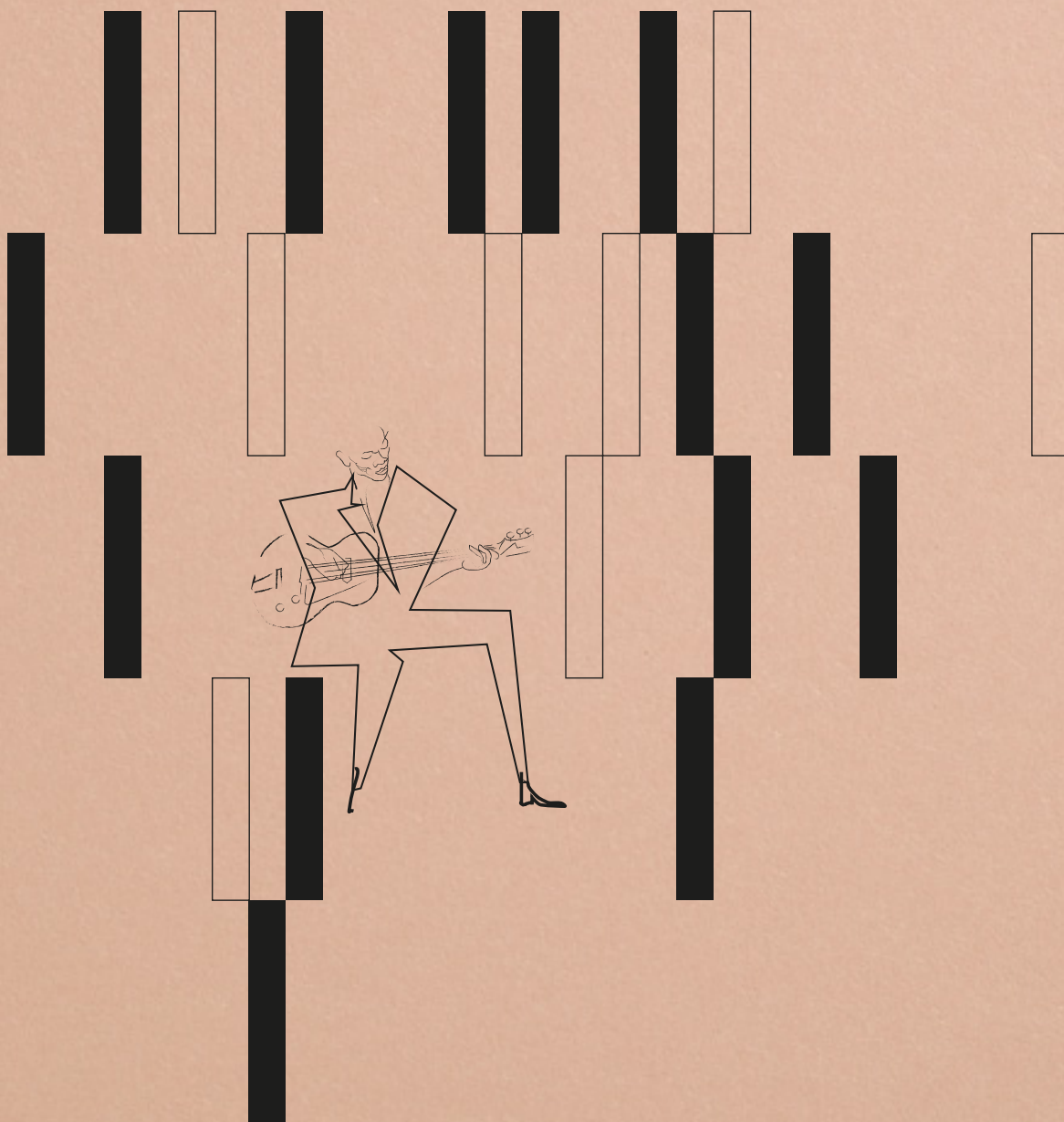

FACTORY 1
Retail division
Showroom
Offices

FACTORY 2
Contract division

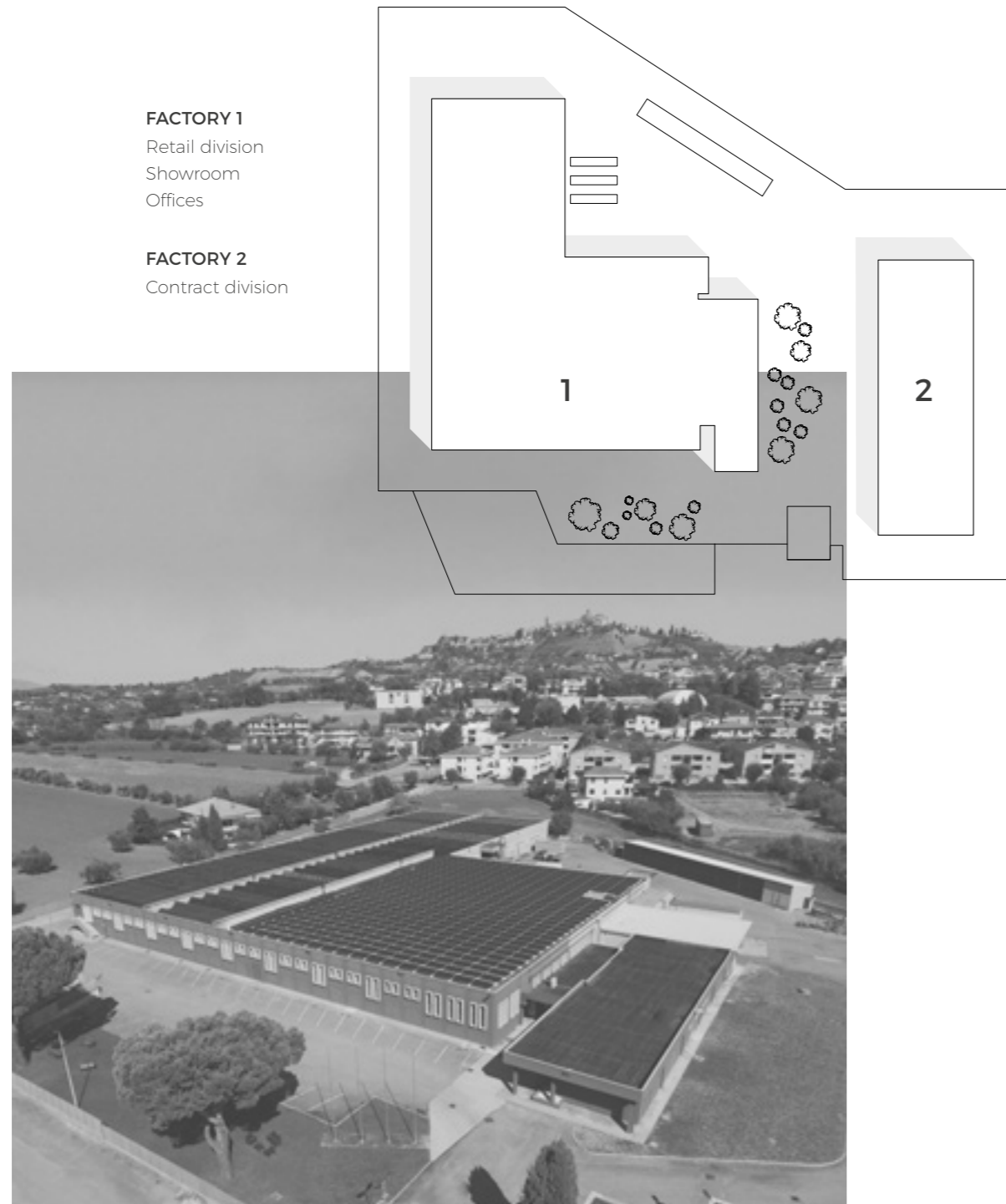

COMPANY

Il brand Guzzini & Fontana nasce dall'incontro di Luca Guzzini, già Presidente della Teuco Guzzini, e Gary Fontana, titolare di OC Shanghai, due imprenditori con una lunga e consolidata esperienza nel settore dell'arredamento. L'azienda, in rapida ascesa, si è recentemente dotata di un nuovo stabilimento, provvisto di moderni macchinari 4.0, ed è in corso una notevole espansione che prevede la realizzazione di un secondo polo produttivo. Il concetto alla base della filosofia di GF Interiors è Made with Love in Italy e racchiude passione nella selezione dei materiali, cura nelle lavorazioni artigianali, attenzione per i dettagli e alta capacità tecnica per un prodotto dallo spiccato valore sartoriale.

The Guzzini & Fontana brand was born from the meeting of Luca Guzzini, former President of Teuco Guzzini, and Gary Fontana, owner of OC Shanghai, two entrepreneurs with a long and consolidated experience in the furniture sector. The rapidly growing company has recently equipped itself with a new plant, equipped with modern 4.0 machinery, and a significant expansion is underway which includes the construction of a second production center. The concept underlying the philosophy of GF Interiors is Made with Love in Italy and contains passion in the selection of materials, care in craftsmanship, attention to detail and high technical capacity for a product with a marked sartorial value.

NIGHT STORIES

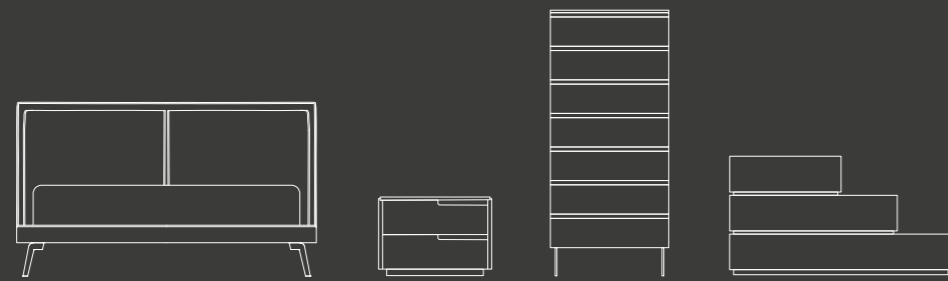

DAY STORIES



ELEMENTS IN JAZZ CONCEPT

Il jazz come processo creativo fondato sull'interazione, sul ritmo, sulla fluidità è la fonte di ispirazione di Elements in Jazz, nuovo catalogo di Guzzini & Fontana. Elementi della zona notte si fondono con quelli della zona giorno, creando spazi infiniti capaci di donare energia e personalità ad ogni ambiente. Il catalogo si pone l'obiettivo di mostrare a pieno in ogni dettaglio tutti i complementi della zona notte, i letti e tutti quelli della zona giorno come madie, tavoli, sedie e coffee tables. In un unico capitolo sarà possibile visionare la collezione declinata in tutte le sue varianti dimensionali e di finitura. Uno strumento concepito per disegnare degli spazi sempre più accoglienti e fruibili, capaci non soltanto di integrare più funzioni ma anche di vestire l'intera abitazione nel segno di un design dall'eleganza contemporanea firmato Guzzini & Fontana.

Jazz as a creative process based on interaction, rhythm and fluidity is the source of inspiration for Elements in Jazz, the new catalog by Guzzini & Fontana. Elements of the night area blend with those of the living area, creating infinite spaces capable of giving energy and personality to every environment. The catalog aims to fully show in every detail all the accessories of the night area, the beds and all those of the living area such as cupboards, tables, chairs and coffee tables. In a single chapter it will be possible to view the collection declined in all its dimensional and finishing variants. A tool conceived to design increasingly welcoming and usable spaces. Capable not only of integrating multiple functions but also of dressing the entire home with a design of contemporary elegance signed by Guzzini & Fontana.

NIGHT STORIES

		5 48 57	
	3 28 37	BOSSA BED & GROOVE	7 68 77
1 08 17	WAINS + SOLO BED & UP-STAGE		SOULWAVE BED & WONDER
DES'REE BED & PAGE		6 58 67	9 88 99
2 18 27	DIZZY BED & KOKO		THELONIOUS BED & ELLINGTON
ELLINGTON BED & MISTY TRAY		4 38 47	8 79 87
	POPS BED & GAP		MIRROR ARABESQUE BED & BIX

1ST STORY

DES'REE BED AND PAGE COLLECTION

I dettagli curvi donano estrema eleganza e ricercatezza ai complementi notte, esaltati ancor di più dalle finiture lucide. Il nuovo letto che richiama le stesse linee è reso unico da una sottile linea di contrasto che avvolge l'intero perimetro.

The curved details give extreme elegance and refinement to the night accessories, enhanced even more by the glossy finishes. The new bed that recalls the same lines is made unique by a thin contrasting line that surrounds the entire perimeter.







DES'REE BED

Il letto DES'REE ha una struttura in multistrato completamente rivestita in tessuto. La testiera ha le estremità curve, come se volesse abbracciare i due cuscini contenuti al suo interno ed è fusa al giroletto grazie ad un unico rivestimento, ulteriore dettaglio è dato dal cordolo che corre lungo l'intero perimetro. I piedi sono in metallo nero. I comodini Page sono caratterizzati da un fianco curvo e da uno liscio con dente per presa maniglia, altra caratteristica è il piano in vetro fumé superiore che genera un vano a giorno ed un cassetto inferiore. Sono realizzati in laccato lucido Grigio LV.

The DES'REE bed has a plywood structure completely upholstered in fabric. The headboard has curved ends to embrace the two inner pillows and is fused to the bed frame thanks to a single cover. A further detail is given by the curb that runs along the entire perimeter. Feet are in black metal. A Page bedside drawers are characterized by a curved side and a straight side with a gap for opening. Another feature is the upper smoked glass top that generates an open compartment and a lower drawer, they are made in glossy lacquered Grigio LV finish.

PAGE COLLECTION

Comò con 4 cassetti Page caratterizzato da un fianco curvo e da uno liscio con dente per presa mangilia, finitura laccato opaco Grigio LV. A destra settimino in finitura laccato lucido Nocciola.

Page dresser with 4 drawers characterized by a curved side and a straight side with a gap for opening, matt lacquered Grigio LV finish. On the right a high chest of drawers in glossy lacquered Nocciola finish.





Struttura in tessuto
Structure in fabric



Ante laccato lucido Cappuccino
Glossy lacquered Cappuccino doors



Ante laccato lucido Ferro e Verde Foresta
Glossy lacquered Ferro and Verde foresta doors

DES'REE BED

Struttura in tessuto, piede in metallo.
Structure in fabric, feet in stainless steel.

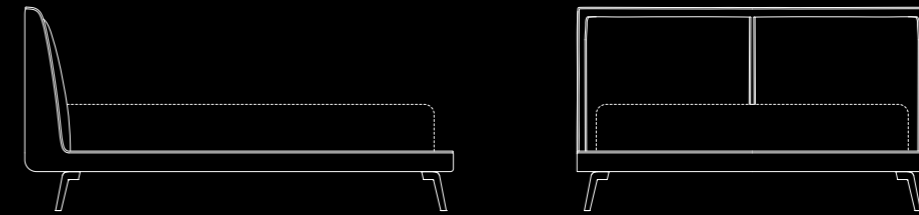

DISPONIBILE IN 3 DIMENSIONI
3 DIMENSIONS AVAILABLE

A W 1800 / H 1040 / D 2200
B W 1800 / H 1040 / D 2300
A W 2000 / H 1040 / D 2300

PAGE COLLECTION

Struttura interamente laccata disponibile in finitura laccato opaco e lucido. Top disponibile in finitura laccato opaco e lucido o vetro.

Entirely lacquered structure available in matt and glossy lacquered finish. Top available in matt and glossy lacquered finish or glass.

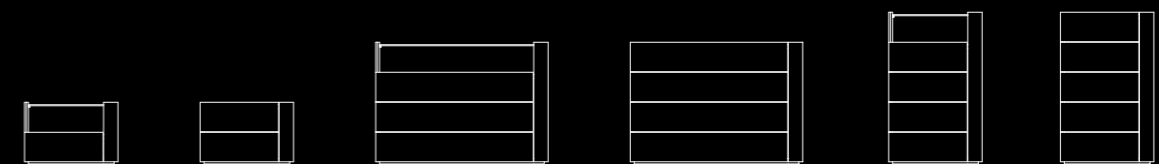

COMODINO
BED SIDE DRAWERS

A / H 351
L / W 532
P / D 411

COMÒ
DRESSER

A / H 695
L / W 982
P / D 411 / 501

SETTIMINO
HIGH CHEST OF DRAWER

A / H 864
L / W 532
P / D 411 / 501

2nd STORY

ELLINGTON BED AND MISTY TRAY COLLECTION

La ricercatezza dei dettagli insita nella collezione Misty tray si fonde a pieno con l'eleganza dei rombi del letto Ellington. Un ambiente reso ancor più unico dalla prestigiosa boiserie Always in legno con porta integrata.

The refined details in Misty tray collection blend fully with the elegance of the diamonds on the Ellington bed. An environment made even more unique by the prestigious Always boiserie in wood with integrated door.







ELLINGTON DIAMOND BED

Il letto ELLINGTON diamond ha una struttura in multistrato completamente rivestita in eco-pelle, finitura Sabbia. La testiera è liscia, mentre il giroletto è caratterizzato da un motivo a rombi con cuciture a contrasto e piedi in metallo nero. I comodini Misty tray sono in struttura alluminio Bronzo e le ante legno Rovere TC. Boiserie Always e porta filo muro in legno Rovere TC rigato.

The ELLINGTON diamond bed has a full structure in plywood eco-leather upholstered Sabbia finish. Its headboard finish is totally flat while the bed frame is characterized by a diamond shape stitching and supported by sharp legs in black finish. Misty tray bedside structure is in aluminum Bronze. Drawer fronts are in Rovere TC wood. Boiserie Always with frameless swing door in Rovere TC ribbed wood.

MISTY TRAY COLLECTION

Madia 4 ante Misty Tray con struttura in alluminio e vasca superiore laccato Nero. Ante in legno impiallacciato finitura Rovere TC. Comò 4 cassetti Misty Tray con struttura in alluminio e vasca superiore laccato Bronzo. Cassetti in legno impiallacciato finitura Frassino BL.

Misty tray sideboard with structure in aluminum and upper tray Nero lacquered. Doors are in wood veneer Rovere TC finish. Misty tray 4 drawers dresser with structure in aluminum and upper tray Bronze lacquered. Drawers are in wood veneer Frassino BL finish.





Struttura in Eco-pelle vintage Pandora 10
Structure in Vintage eco-leather Pandora 10



Ante Laccato opaco Bronzo
Matt lacquered Bronzo doors



Ante legno impiallacciato Frassino BL
Wood veneer Frassino BL finish doors

ELLINGTON DIAMOND BED

Struttura in Eco-pelle o Eco-pelle vintage, piede in metallo.
Structure in Eco-leather or Vintage eco-leather, feet in stainless steel.

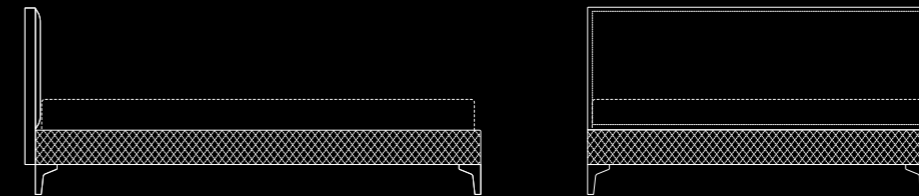

DISPONIBILE IN 3 DIMENSIONI
3 DIMENSIONS AVAILABLE

A W 1770 / H 880 / D 1910
B W 1770 / H 880 / D 2110
A W 1910 / H 880 / D 2110

MISTY TRAY COLLECTION

Struttura in alluminio ossidato o laccato opaco, vassoio laccato opaco, Ante disponibili in finiture:
Bilaminato, laccato opaco e lucido, legno impiallacciato e impiallacciato esotico

Structure in oxidated or matt lacquered aluminum, tray in matt lacquered finish. Available door finishes:
Bilaminated, matt or glossy lacquered, wood veneer or exotic wood veneer.



COMO 3C
3D DRESSER
A / H 783
L / W 940 / 1240
P / D 410 / 500

COMODINO
BED SIDE DRAWERS
A / H 612
L / W 540 / 640
P / D 410 / 500

COMO 4C
4D DRESSER
A / H 953
L / W 940 / 1240
P / D 410 / 500

SETTIMINO
HIGH CHEST OF DRAWER
A / H 1294
L / W 540 / 640
P / D 410 / 500

MADIA
SIDEBOARD
A / H 948
L / W 1840 / 2440
P / D 410 / 500

3rd STORY

WAINS + SOLO BED AND UP-STAGE COLLECTION

Il ritmo verticale scandito dalla doga Tempo amplifica lo spazio e dà ancor più valore agli affascinanti segni orizzontali lasciati dai complementi Stage.

The vertical rhythm marked by the Tempo pattern amplifies the space and gives even more value to the fascinating horizontal signs left by the Stage complements.







WAINS HEADBOARD WITH SOLO BED

Testiera del letto realizzata con boiserie dogata Tempo in finitura legno Frassino BL e led superiore. Giroletto Solo realizzato in tessuto finitura Roma 10. Comodini Up-stage in finitura laccato opaco Dusty gray, maniglia e top in finitura legno Frassino BL.

Headboard made with Tempo pattern boiserie in wood Frassino BL finish and upper LED. Solo bed frame in fabric Roma 10 finish. Up-stage bedside drawers in matt lacquered Dusty gray finish, handle and top in wood Frassino BL finish.

UP-STAGE COLLECTION

Comodino Up-stage in finitura laccato opaco Dusty Gray con maniglia e top in finitura legno Frassino BL. Madia Up-stage in finitura laccato opaco Cappuccino con maniglia e top in finitura legno Frassino BL.

Up-stage bedside drawers in Dusty Gray matt lacquered finish with handle and top in wood Frassino BL finish. Up-stage sideboard in matt lacquered Cappuccino finish with handle and top in wood Frassino BL finish.





Boiserie Wains Tempo Frassino BL e giroletto Roma 23
Wains boiserie Tempo Frassino BL and bedframe Roma 23



Laccato opaco Grigio BX e legno Rovere FM
Matt lacquered Grigio BX and wood Rovere FM



Laccato opaco Arabian clay e Grigio AT, legno Rovere FM
Matt lacquered Arabian clay and Grigio AT, wood Rovere FM

WAINS HEADBOARD WITH SOLO BED

Giroletto in tessuto Roma e velluto Viky. Testiera Wains in legno con predisposizione led lato superiore.
Bedframe in Roma fabric and Viky velvet. Headboards Wains in wood with predisposition for led lighting.

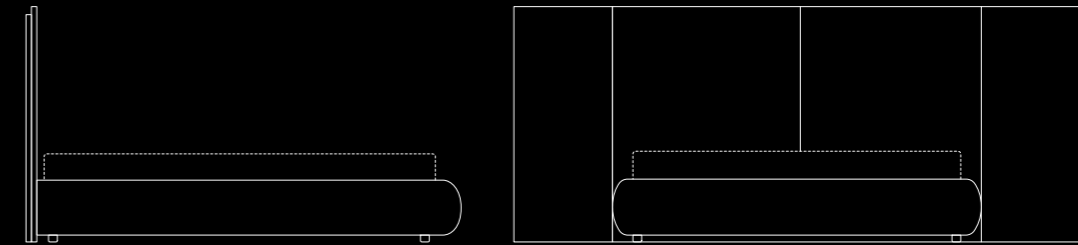

GIROLETTO 2 DIMENSIONI DISPONIBILI
BEDFRAME AVAILABLE IN 2 DIMENSIONS

A W 1800 / H 350 / D 2000
B W 2200 / H 350 / D 2100

TESTIERA WAINS
WAINS HEADBOARD DIMENSIONS

W 450 / 900
H 1400

UP-STAGE COLLECTION

Struttura in bilaminato. Ante e maniglia disponibili in finiture:
Laccato opaco e lucido, legno impiallacciato e impiallacciato esotico.

Structure in bilaminate. Available door and handle finishes:
Matt or glossy lacquered, wood veneer and exotic wood veneer.

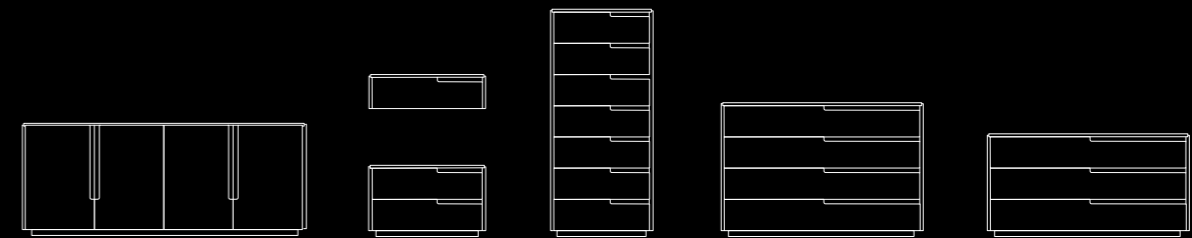

MADIA
SIDEBOARD

A / H 728
L / W 1824 / 2424
P / D 410 / 500

COMODINO
BED SIDE DRAWER

A / H 185 / 384
L / W 524 / 624
P / D 410 / 500

SETTIMINO
HIGH CHEST OF DRAWER

A / H 1238
L / W 524 / 624
P / D 410 / 500

COMO 4C
4D DRESSER

A / H 726
L / W 924 / 1224
P / D 410 / 500

COMO 3C
4D DRESSER

A / H 555
L / W 924 / 1224
P / D 410 / 500

4th STORY

POPS BED AND GAP COLLECTION

Il fascino di un ambiente in stile Japandi, i toni caldi della boiserie Tempo con doghe sfalsate e le essenze lignee delicate donano armonia e leggerezza ad uno spazio senza tempo.

The charm of a Japandi-style environment, the warm tones of the Tempo boiserie with staggered staves and the delicate wood essences give harmony and lightness to a timeless space.







POPS BED

Il letto POPS ha una struttura in multistrato completamente rivestita in tessuto finitura Roma 06. I comodini Gap sono in finitura laccato opaco Sahara BG, mentre la maniglia incassata è in alluminio nero. A destra la boiserie Tempo laccata opaca finitura Sahara BG accoglie una comoda area trucco e lo specchio Rebus composto da cornice in alluminio nero e specchio retro-illuminato su 3 lati.

The POPS bed has a plywood structure completely covered in fabric Roma 06 finish. The Gap bedside drawers are in matt lacquered Sahara BG finish. Recessed handle is in black aluminum. On the right, a boiserie Tempo in matt lacquered Sahara BG finish encloses a comfortable make-up area and the Rebus mirror composed of a black aluminum frame and a 3 sides back-lit mirror.

GAP COLLECTION

Comodino Gap in laccato opaco finitura Sahara BG, basamento nero opaco e maniglia in alluminio nero. Settimini Gap in laccato opaco finitura Terracotta, basamento nero opaco e maniglia in alluminio nero.

Gap bedside drawers in matt lacquered Sahara BG finish, base matt black finish and handle in black aluminum. Gap high chest of drawers in matt lacquered Terracotta finish, base matt black finish and handle in black aluminum.





Struttura in tessuto Roma 32
Structure in fabric Roma 32



Ante laccato opaco Grigio LV
Matt lacquered Grigio LV doors



Ante bilaminato Rovere Japan e laccato opaco Dusty grey
Bilaminated Rovere Japan and matt lacquered Dusty grey finish doors

POPS BED

Struttura in tessuto Roma e velluto Viky.
Structure in Roma fabric and Viky velvet.

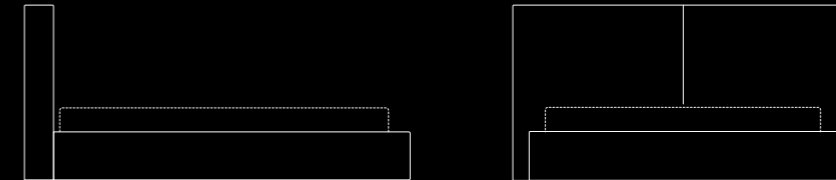

DISPONIBILE IN 2 DIMENSIONI
2 DIMENSIONS AVAILABLE

A W 2280 / H 1380 / D 2300
B W 2480 / H 1380 / D 2400

GAP COLLECTION

Struttura in bilaminato, basamento in laccato opaco. Ante disponibili in finiture: bilaminato, laccato opaco e lucido, impiallacciato e impiallacciato esotico.

Structure in bilaminated, feet are in matt lacquered. Available door finishes: bilaminated, matt or glossy lacquered, wood veneer and exotic wood veneer.

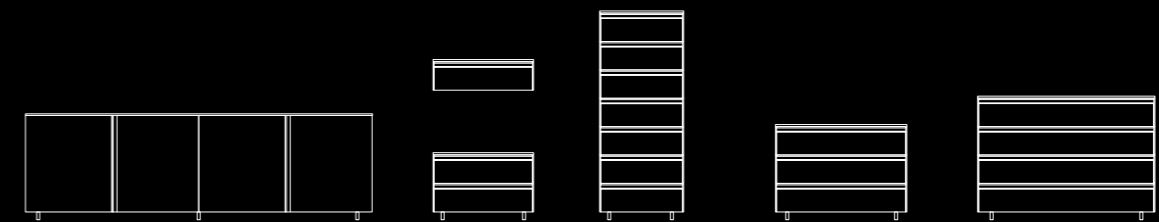

MADIA
SIDEBOARD

A / H 744
L / W 1800 / 2400
P / D 410 / 500

COMODINO
BED SIDE DRAWER

A / H 189 / 390
L / W 500 / 600
P / D 410 / 500

SETTIMINO 7C
HIGH CHEST OF DRAWER

A / H 1244
L / W 500 / 600
P / D 410 / 500

COMO 3C
3D DRESSER

A / H 561
L / W 900 / 1200
P / D 410 / 500

COMO 4C
4D DRESSER

A / H 752
L / W 900 / 1200
P / D 410 / 500

5th STORY

BOSSA BED AND GROOVE COLLECTION

L'estrema morbidezza del letto Bossa viene risaltata dalla rigorosa boiserie Always con doghe a passo costante e dai complementi Groove, creando così un affascinante ed insolito gioco di luci ed ombre.

The extreme softness of the Bossa bed is highlighted by the rigorous Always boiserie with staves at a constant pitch and by the Groove accessories, creating a fascinating and unusual game of lights and shadows.

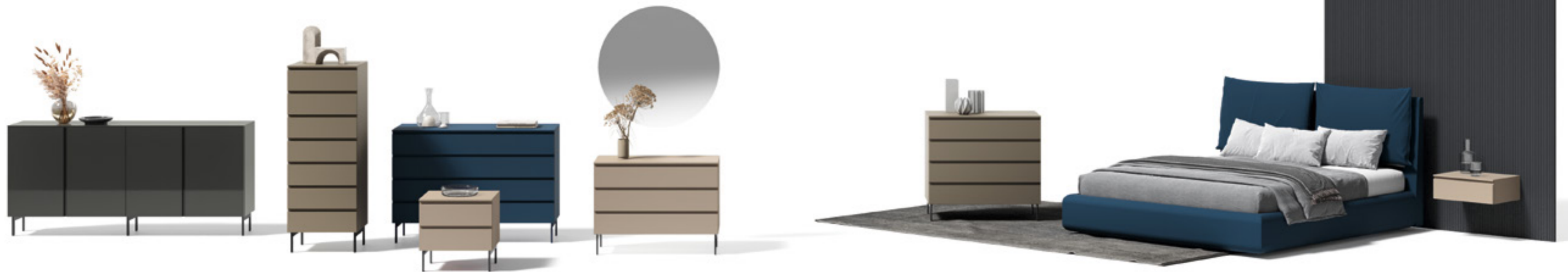





BOSSA BED

Il letto Bossa ha una struttura in multistrato completamente rivestita in velluto finitura Viky 30. La testiera è caratterizzata da due grandi cuscini che ripercorrono le stesse finiture del giroletto. I comodini Groove hanno un basamento in metallo nero e le ante laccato opaco finitura Visone. La boiserie Always è in legno finitura Frassino BL.

The Bossa bed has a plywood structure completely covered in velvet Viky 30 finish. The headboard is characterized by two large cushions in the same finishes as the bed frame. The Groove bedside drawers have a black metal base and matt lacquered doors Visone finish. The Always boiserie is in wood Frassino BL finish.

GROOVE COLLECTION

Comodino Groove con basamento in metallo nero opaco, ante laccato opaco finitura Visone con presa maniglia integrata. Madia Groove in laccato opaco finitura Dusty gray e basamento in metallo Bronzo. Specchio Rebus composto da cornice in alluminio Bronzo e specchio retro-illuminato su 3 lati.

Groove bedside drawers with matt black metal base, matt lacquered doors in Visone finish with integrated handle grip. Groove sideboard in matt lacquered Dusty gray finish and Bronze metal base. Rebus mirror is composed of a Bronze aluminum frame and a 3 sides back-lit mirror.





Struttura in velluto Viki 33
Structure in velvet Viki 33



Ante laccato opaco Cappuccino
Matt lacquered Cappuccino finish doors



Ante laccato opaco Dusty grey e Grigio AT
Matt lacquered Grigio AT and Dusty grey finish doors

BOSSA BED

Struttura in tessuto Roma e velluto Viki.
Structure in Roma fabric and Viki velvet.

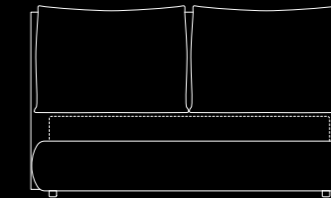

DISPONIBILE IN 2 DIMENSIONI
2 DIMENSIONS AVAILABLE

A W 1780 / H 1350 / D 2110
B W 2210 / H 1350 / D 2210

GROOVE COLLECTION

Struttura in bilaminato, basamento in metallo laccato opaco. Ante disponibili in finiture:
Laccato opaco e lucido.

Structure in bilaminated, feet are in matt lacquered metal. Available door finishes:
Matt or glossy lacquered.

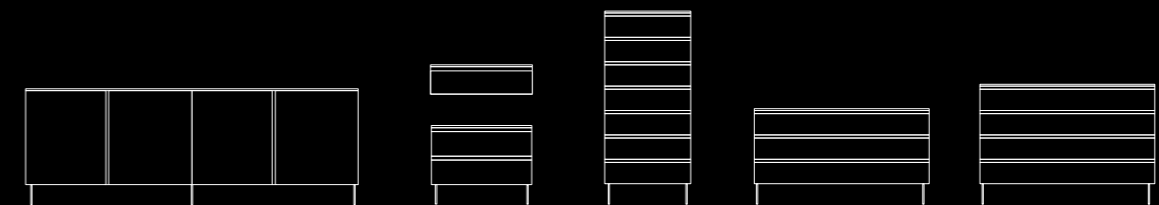

MADIA
SIDEBOARD

A / H 846
L / W 1800 / 2400
P / D 410 / 500

COMODINO
BED SIDE DRAWER

A / H 183 / 504
L / W 500 / 600
P / D 410 / 500

SETTIMINO 7C
HIGH CHEST OF DRAWER

A / H 1356
L / W 500 / 600
P / D 410 / 500

COMO 3C
3D DRESSER

A / H 675
L / W 900 / 1200
P / D 410 / 500

COMO 4C
4D DRESSER

A / H 846
L / W 900 / 1200
P / D 410 / 500

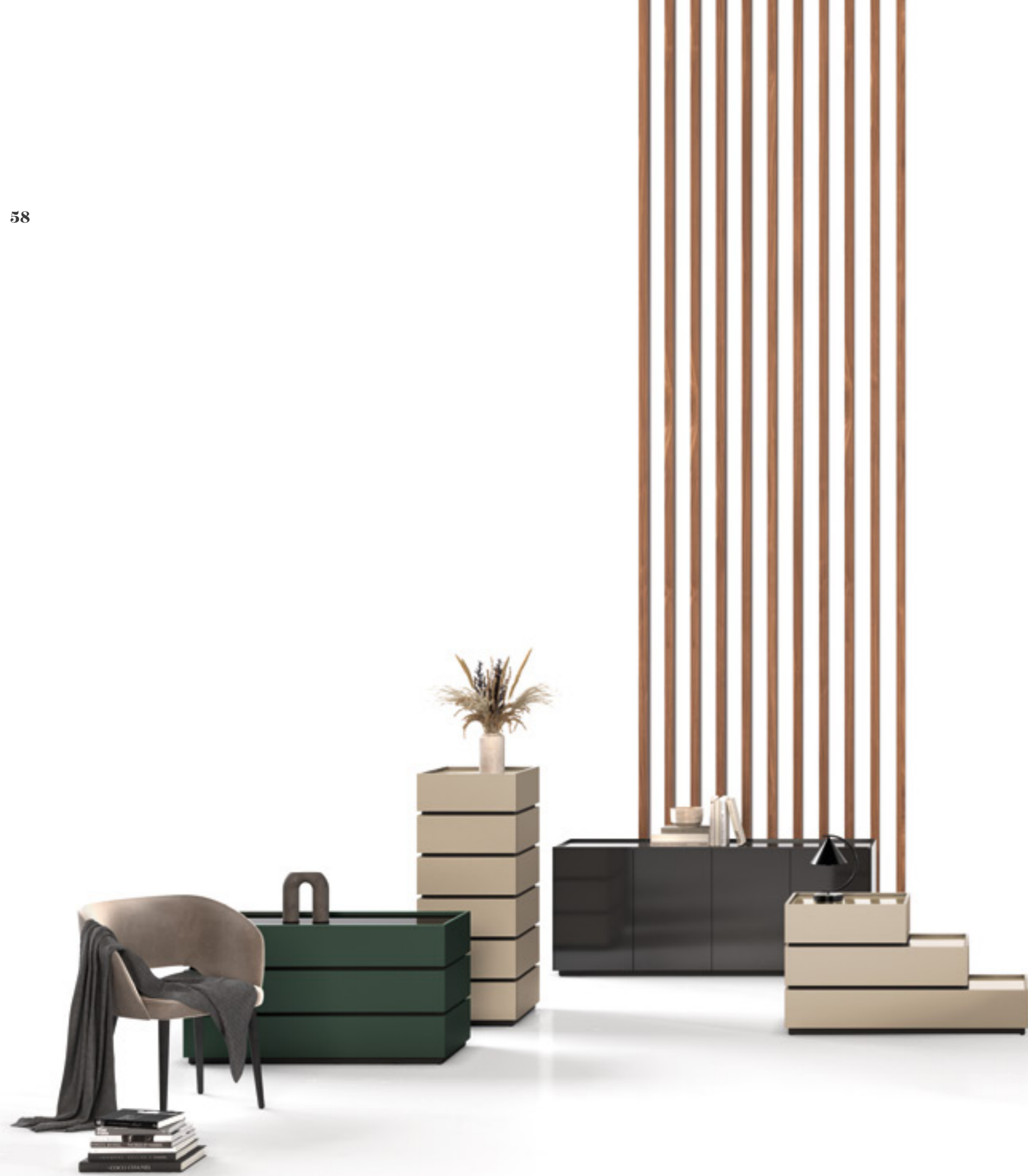

6th STORY

DIZZY BED AND KOKO COLLECTION

Il calore delle boiserie in Noce dona all'ambiente un senso di accoglienza, mentre la leggerezza dei complementi Koko e la sospensione del letto Dizzy arricchiscono uno spazio senza tempo.

The warmth of the walnut boiserie gives the room a sense of hospitality, while the lightness of the Koko collection and the suspension of the Dizzy bed enrich a timeless space.







DIZZY BED

Un design rigoroso per il letto Dizzy in laccato opaco finitura Grigio AT. La testiera è caratterizzata da un intercapedine che corre lungo tutto il perimetro, alla quale è possibile aggiungere delle prolunghe ai lati con illuminazione led. Il giroletto ha un inserto in eco-pelle centrale. I comodini Koko sono in laccato opaco finitura Bronzo e top in vetro lucido nero.

A rigorous design for Dizzy bed in matt lacquered Grigio AT finish. The headboard is characterized by a cavity that runs along the entire perimeter, to which it is possible to add extensions to the sides with LED lighting. The bed frame has a central eco-leather insert. The Koko bedside tables are in matt lacquered Bronze finish and top in glossy black glass.

KOKO COLLECTION

Comodino Koko in laccato opaco finitura Bronzo, inserti intermediari nero opaco e top in vetro lucido nero. Comò Koko con 3 cassetti in laccato lucido finitura Cappuccino e top in vetro lucido nero.

Koko bedside drawers in matt lacquered Bronze finish, intermediate inserts in matt black and top in glossy black glass. Koko dresser with 3 drawers in glossy lacquered Cappuccino finish and top in black glossy glass.





Struttura in laccato opaco Cappuccino
Structure matt lacquered Cappuccino

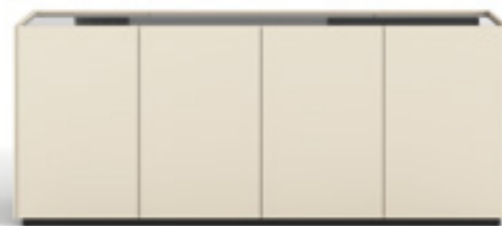

Ante laccato opaco Sahara BG
Matt lacquered Sahara BG doors



Ante laccato opaco Grigio LV e Ferro
Matt lacquered Grigio LV and Ferro doors

DIZZY BED

Struttura in bilaminato, laccato opaco, impiallacciato e impiallacciato esotico, con inserto in eco-pelle, piede in metallo.
Structure in bilaminate, matt lacquered, wood veneer and exotic wood veneer with Eco-leather insert, feet in stainless steel.



DIMENSIONI DISPONIBILI
AVAILABLE DIMENSIONS

A / W 1850 / H 920 / D 2150

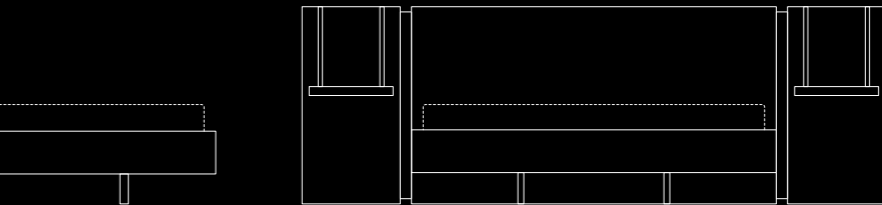

DIMENSIONI TESTIERA AGGIUNTIVA
ADDITIONAL HEADBOARD DIMENSIONS

W 450 / 600

KOKO COLLECTION

Struttura in bilaminato. Ante disponibili in finiture:
Bilaminato, laccato opaco e lucido.

Structure in bilaminate. Available door finishes:
Bilaminate, matt or glossy lacquered.

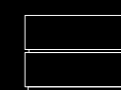

COMODINO
BED SIDE DRAWER

A / H 431
L / W 502 / 602
P / D 432 / 522

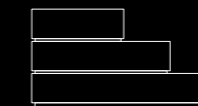

COMO
DRESSER

A / H 640
L / W 1202
P / D 432 / 522



COMO
DRESSER

A / H 640
L / W 1202
P / D 432 / 522

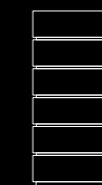

SETTIMINO
HIGH CHEST OF DRAWER

A / H 1267
L / W 502 / 602
P / D 432 / 522

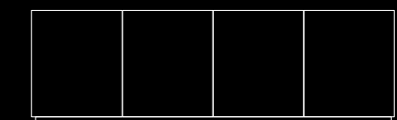

MADIA
SIDEBOARD

A / H 741
L / W 1838 / 2438
P / D 432 / 522

7th STORY

SOULWAVE BED AND WONDER COLLECTION

Un continuo gioco di sottrazione per dar forma a nuovi elementi dal fascino distintivo. L'armonia del letto Soulwave si sposa a pieno con il dinamismo dei complementi Wonder in uno spazio ricco di personalità.

A continuous game of subtraction gives shape to new elements with a distinctive charm, the harmony of Soulwave bed blends perfectly with the dynamism of Wonder accessories in a space full of personality.







SOULWAVE BED

Un design evoluto per il letto Soulwave che ha una struttura in laccato opaco finitura Sahara BG e giroletto con taglio perimetrale 30°. La testiera è realizzata con un doppio pannello laccato e legno finitura Frassino BL per creare un dente in cui è inserita una luce led, infine due grandi cuscini completamente rivestiti in tessuto donano morbidezza al tutto. A destra viene sospeso un cassetto con taglio 45°.

An advanced design for the Soulwave bed that has a structure in matt lacquered Sahara BG finish and a bed frame with a 30° perimetral cut. The headboard is made with a double layer of lacquered and wood panel with Frassino BL finish to allow a gap in which a led light is inserted, finally two large cushions completely covered in fabric give softness to the whole. A drawer with a 45° cut is suspended on the right.

WONDER COLLECTION

Comodino e comò Wonder con struttura laccato opaco finitura Sahara BG e cassetti in bilaminato finitura Noce NT. L'apertura è garantita per mezzo di un lamello in alluminio affogato nel ripiano.

Wonder bedside drawers and dresser with matt lacquered structure in Sahara BG finish and drawers in bilaminate Noce NT finish. Opening is guaranteed by means of an aluminum lamel drowned in the shelf.





Struttura laccato opaco Grigio LV e legno Noce CN
Structure in matt lacquered Grigio LV and Noce CN wood finish



Bilaminato Noce NT
Bilaminated Noce NT



Laccato opaco Cappuccino e Dusty Grey
Matt lacquered Cappuccino and Dusty grey finish

SOULWAVE BED

Struttura in laccato opaco e impiallacciato, piede in metallo.
Structure in matt lacquered and wood veneer, feet in stainless steel.

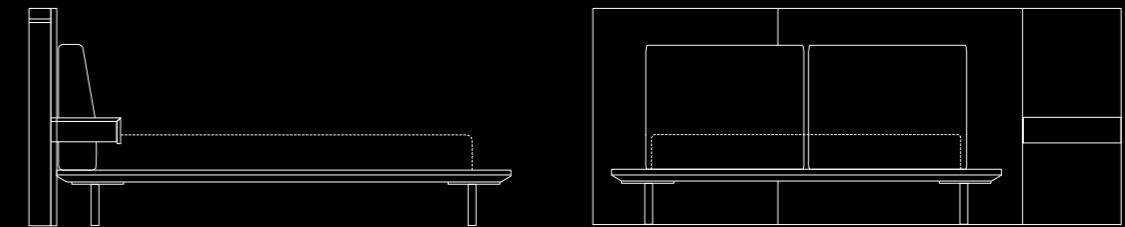

DISPONIBILE MONOFACCIALE E CENTRO STANZA
AVAILABLE ONE SIDED AND DOUBLE SIDED

A / W 2680 / H 1400 / D 2500

WONDER COLLECTION

Struttura in bilaminato STR e laccato opaco.
Structure in STR bilaminated and matt lacquered.

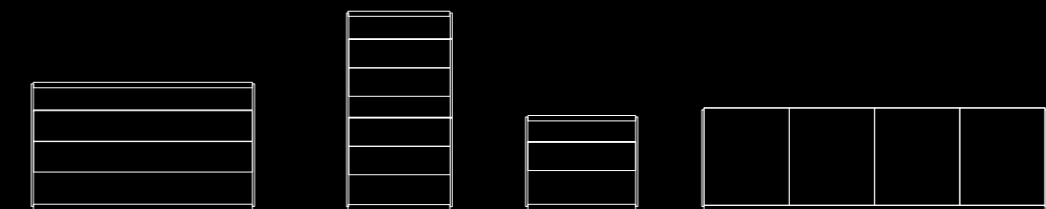

COMO
DRESSER

A / H 670
L / W 956 / 1236
P / D 430 / 520

SETTIMINO
HIGH CHEST OF DRAWER

A / H 1185
L / W 536 / 636
P / D 430 / 520

COMODINO
BED SIDE DRAWERS

A / H 524
L / W 536 / 636
P / D 430 / 520

MADIA
SIDEBOARD

A / H 744
L / W 1836 / 2436
P / D 430 / 520

8th STORY

MIRROR ARABESQUE BED AND BIX COLLECTION

Il ritmo delle curve dato dalla testata del letto Arabesque predomina la scena, volumi fluidi ed eterei si contrappongono alla razionalità dei complementi Bix.

The rhythm of the curves given by the headboard of the Arabesque bed dominates the scene. Fluid and ethereal volumes contrast with the rationality of the Bix complements.

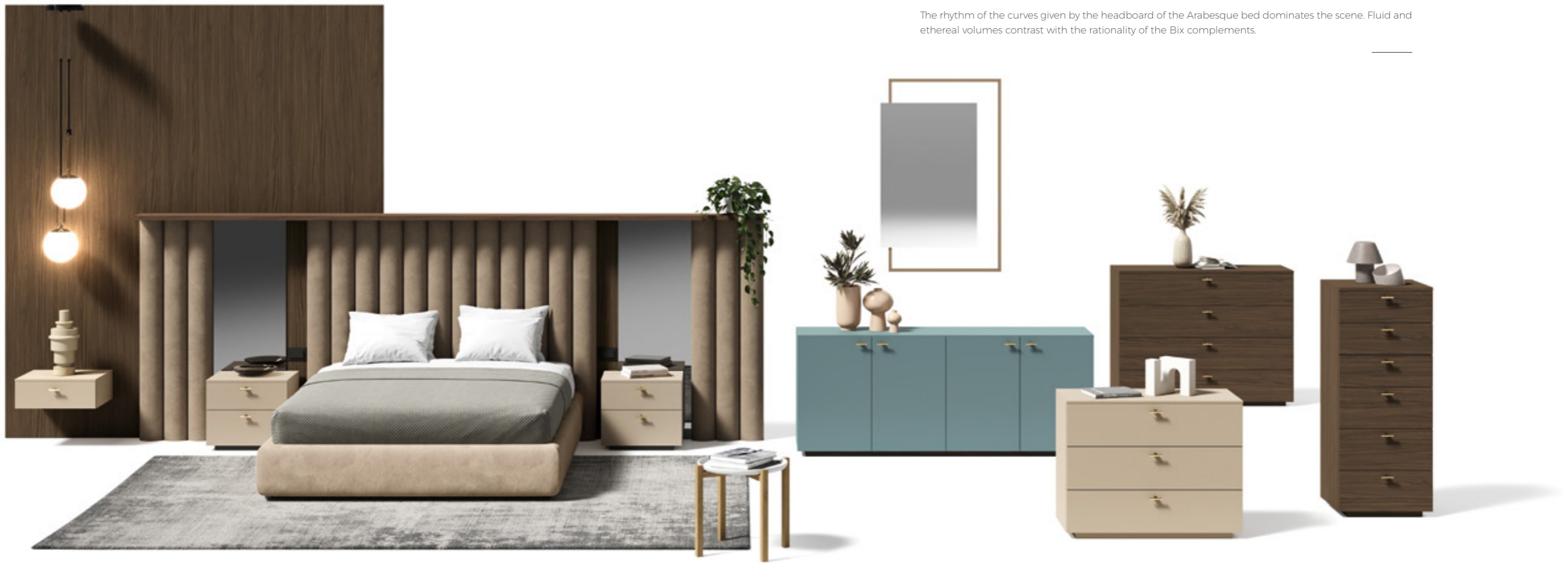





MIRROR ARABESQUE BED

Letto Mirror Arabesque in tessuto Viky 08 con schienali in vetro specchio bronzo e inserto in legno con predisposizione prese elettriche in finitura Mandorlo, mensola con illuminazione Led. Boiserie in bilaminato legno finitura Mandorlo posta sopra il letto. Comodini Bix laccato opaco finitura Cappuccino e maniglia Webb finitura bronzo.

Mirror Arabesque bed in Viky 08 fabric with back panels in bronze mirror glass and wooden insert with predisposition for switches in Mandorlo finish, shelf with Led lighting. Boiserie in wood bilaminato Mandorlo finish placed above the bed. Bix bedside drawers in matt lacquered Cappuccino finish and Webb handle in bronze finish.

BIX COLLECTION

Comò Bix con 3 cassetti in bilaminato finitura Beton VS e maniglia Webb in finitura bronzo. Madia Bix in laccato opaco finitura Grigio AT con stessa maniglia. Specchio Rebus composto da cornice in alluminio nero e specchio retro-illuminato su 3 lati.

Bix dresser with 3 drawers in bilaminated Beton VS finish and Webb handle in bronze finish. Bix sideboard in matt lacquered Grigio AT finish with the same handle. Rebus mirror composed of a black aluminum frame and a 3 sides backlit mirror.





Struttura velluto Viky 08
Structure velvet Viky 08

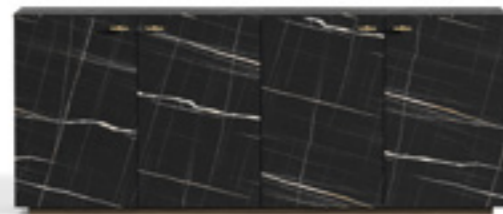

Bilaminato Africa BK
Bilaminato Africa BK



Bilaminato Fango e laccato opaco Rosso PP
Bilaminato Fango and matt lacquered Rosso PP finish

MIRROR ARABESQUE BED

Struttura composta da schienale e giroletto in tessuto Roma e velluto Viky, specchi laterali e mensola con illuminazione led opzionale, piede in metallo.
Structure composed with headboard and bedframe in Roma fabric and Viky velvet, mirrors and shelf with optional LED lighting, feet in stainless steel.



DISPONIBILE IN 2 DIMENSIONI
2 DIMENSIONS AVAILABLE
A W 1800 / H 1400 / D 2150
B W 2000 / H 1400 / D 2250

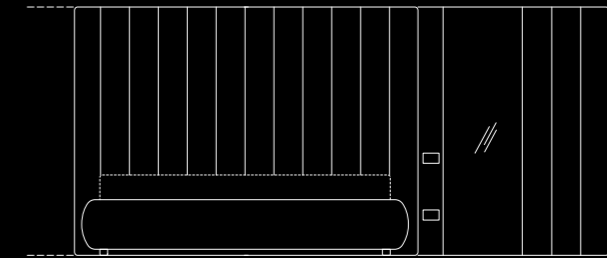

DIMENSIONI SPECCHIO
MIRROR DIMENSIONS AVAILABLE
A W FROM 450 TO 600 / H 1400
B W FROM 600 TO 800 / H 1400

BIX COLLECTION

Struttura in bilaminato. Ante, top e fianchi disponibili in finiture: Bilaminato e laccato opaco.

Structure in bilaminate. Available finishes for door, top and sides: Bilaminato and matt lacquered.

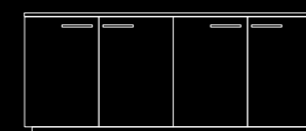

MADIA
SIDEBOARD
A / H 752
L / W 1802 / 2402
P / D 410 / 500



COMODINO
BED SIDE DRAWER
A / H 190 / 441
L / W 502 / 602
P / D 410 / 500



SETTIMINO
HIGH CHEST OF DRAWER
A / H 1225
L / W 502 / 602
P / D 410 / 500

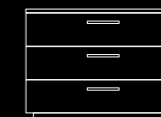

COMO 3C
3D DRESSER
A / H 712
L / W 903 / 1202
P / D 410 / 500



COMO 4C
4D DRESSER
A / H 943
L / W 902 / 1202
P / D 410 / 500



9th STORY

THELONIOUS BED AND ELLINGTON COLLECTION

Il carattere del letto Thelonious realizzato in legno ed i complementi Ellington con i loro terminali sottili e sporgenti, consentono allo sguardo una prospettiva inedita e di estrema libertà.

The character of the Thelonious bed made of wood and the Ellington complements with their thin and protruding ends allow the eye to view a new perspective and extreme freedom.







THELONIOUS BED

Letto Thelonious realizzato interamente in legno finitura Frassino nero. I comodini Ellington sono in laccato opaco finitura Lampone e la boiserie retrostante con Led laterale è realizzata in impiallacciato legno finitura Frassino BL. Comò costituito da cassetti in laccato opaco finitura Visone e fianchi in impiallacciato legno finitura Frassino BL.

Thelonious bed made entirely of wood Frassino nero finish. The Ellington bedside drawers are in matt lacquered Lampone finish and the rear boiserie with LED on one side is made of wood veneer Frassino BL finish. Dresser 4D made up of drawers in matt lacquered Visone finish and sides in wood veneer with Frassino BL finish.

ELLINGTON COLLECTION

Comodini Ellington in laccato opaco finitura Lampone, la caratteristica principale di tutta la collezione sono i fianchi sporgenti ed i cassetti push-pull. Madia Ellington costituita da ante in laccato lucido finitura Grigio AT e fianchi in impiallacciato legno finitura Noce CN. Specchio Rebus composto da cornice in alluminio bronzo e specchio retro-illuminato su 3 lati.

Ellington bedside drawers in matt lacquered Lampone finish, the main feature of the whole collection are the protruding sides and the push-pull drawers. Ellington sideboard made of doors in glossy lacquered Grigio AT finish and sides in wood veneer Noce CN finish. Rebus mirror made up of a bronze aluminum frame and backlit mirror on 3 sides.





Struttura legno Frassino Fumo
Structure Frassino Fumo wood



Bilaminato Beton VS e legno imp. Rovere TC
Bilaminated Beton VS and wood veneer Rovere TC

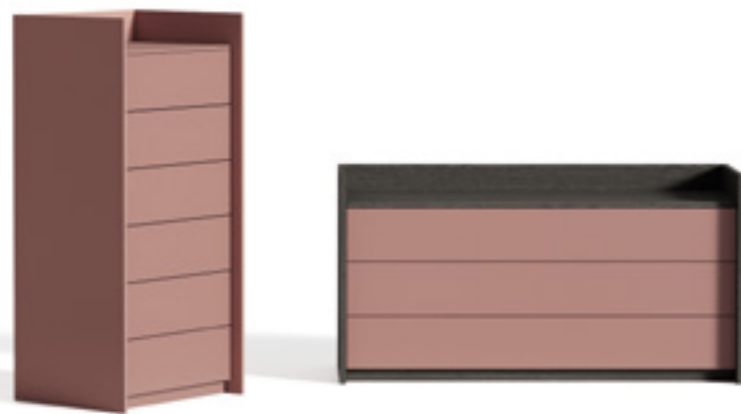

Laccato opaco Arabian clay e legno Frassino BL
Matt lacquered Arabian clay and Frassino BL wood

THELONIOUS BED

Struttura in legno impiallacciato.
Structure in wood veneer.

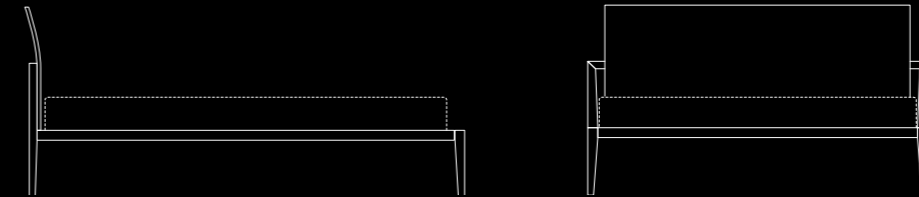

2 DIMENSIONI DISPONIBILI
AVAILABLE 2 DIMENSIONS

A W 1770 / H 950 / D 2020
B W 1770 / H 950 / D 2120

ELLINGTON COLLECTION

Struttura in bilaminato. Ante disponibili in finiture:
Bilaminato, laccato opaco o lucido, impiallacciato e impiallacciato esotico.

Structure in bilaminated. Available door finishes:
Bilaminated, matt or glossy lacquered, wood veneer and exotic wood veneer.

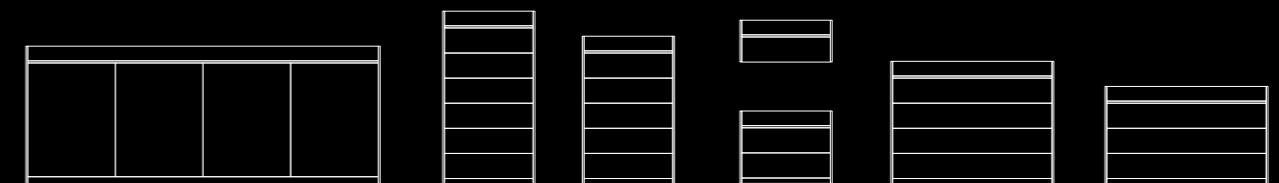

MADIA
SIDEBOARD

A / H 816
L / W 1838 / 2438
P / D 448 / 538

SETTIMINO 6C
HIGH CHEST OF DRAWER

A / H 1157
L / W 538 / 638
P / D 448 / 538

SETTIMINO 5C
HIGH CHEST OF DRAWER

A / H 987
L / W 538 / 638
P / D 448 / 538

COMODINO
BED SIDE DRAWER

A / H 263 / 474
L / W 938 / 638
P / D 448 / 538

COMO 4C
4D DRESSER

A / H 816
L / W 938 / 1238
P / D 448 / 538

COMO 3C
3D DRESSER

A / H 645
L / W 938 / 1238
P / D 448 / 538

DAY STORIES

		14 116 117 DEE DEE S SIDEBOARD	18 128 129 ELLINGTON AND BASE SIDEBOARD
	12 108 109 JACKIE SIDEBOARD	17 126 127 BARON SIDEBOARD	19 130 135 QUEEN SIDEBOARD
10 100 105 LOVIE SIDEBOARD	15 118 119 SHAKE SIDEBOARD		20 136 137 BILLIE SIDEBOARD
11 106 107 WES SIDEBOARD	13 110 115 DEE DEE SIDEBOARD	16 120 125 GINGER SIDEBOARD	



10th STORY

MADIA LOVIE

L'accoglienza ed il fascino delle superfici curve della madia Lovie e del tavolo Yass si mescolano a pieno in un ambiente rigoroso e di estrema eleganza.

The welcome and charm of the curved surfaces of the Lovie sideboard and the Yass table mix fully in a rigorous and extremely elegant environment.



MADIA LOVIE

Madia Lovie costituita da ante laccato lucido finitura Grigio LV, top in gres finitura Nero Atlante glossy e basamento Floating trasparente. Tavolo Yass laccato opaco finitura nero. Coffee table Jaco in laccato opaco finitura Grigio LV e bilaminato legno finitura Noce AM.

Lovie sideboard made up of glossy lacquered doors in Grigio LV finish, top in gres Nero Atlante glossy finish and Floating transparent base. Yass table in matt lacquered black finish. Jaco coffee table in matt lacquered Grigio LV finish and bilaminated wood Noce AM finish.





11th STORY

MADIA WES

Madia Wes costituita da struttura interna in bilaminato finitura Noce NT. Ante Evans air in alluminio nero con cerniere affogate sul fondo e cappello e vetro trasparente fumè. Top e fianchi esterni in laccato metallo liscio finitura Brunito. Basamento Groove in metallo nero.

Wes sideboard made up of an internal structure in bilaminate Noce NT finish. Evans air doors in black aluminum with drowned hinges on the bottom and top and smoked transparent glass. Top and external sides in smooth metal lacquered Brunito finish. Groove base in black metal.





12th STORY

MADIA JACKIE

Madia Jackie in laccato lucido finitura Terracotta, vano a giorno in laccato opaco finitura Nero e ripiano in vetro fumè. Basamento Floating trasparente.

Jackie sideboard in glossy lacquered Terracotta finish, open space unit in matt lacquered Nero finish and smoked glass shelf. Floating transparent base.





13th STORY

MADIA DEE DEE

Un'unica linea, centro di infiniti spunti progettuali: dalla madia Dee dee ricca di dettagli di pregio, passando per le boiserie illuminate in legno e laccato e terminando con la porta integrata filomuro.

A single line, the center of infinite design ideas: from Dee dee sideboard full of precious details, passing through illuminated wood panels and lacquered boiserie and ending with the integrated flush door.



MADIA DEE DEE

Madia Dee Dee costituita da ante laccato opaco Tempo finitura Cappuccino. Top in bilaminato finitura Mandorlo ed eco-pelle finitura Nero. Basamento Cross in bilaminato finitura Mandorlo con inserti in alluminio bronzo. Coffee table Jaco in laccato opaco finitura Nero e Bronzo, top in eco-pelle finitura Nero.

Dee Dee sideboard made up of Tempo matt lacquered doors Cappuccino finish. Top in bilaminated Mandorlo finish and eco-leather Nero finish. Cross base in bilaminated Mandorlo finish with bronze aluminum inserts. Jaco coffee table in matt lacquered Nero and Bronzo finish, top in eco-leather Nero finish.





14th STORY

MADIA DEE DEE S

Madia Dee Dee S costituita da ante laccato opaco Tempo finitura Verde Foresta, top in vetro laccato lucido finitura Nero. Basamento Cross in laccato opaco Verde Foresta con inserti in alluminio bronzo.

Dee Dee S sideboard made up of Tempo matt lacquered doors Verde Foresta finish, top in glossy lacquered glass Nero finish. Cross base in matt lacquered Verde Foresta finish with bronze aluminum inserts.





15th STORY

MADIA SHAKE

Madia Shake in legno impiallacciato con doga Tempo finitura Noce CN, top in vetro laccato lucido finitura Nero e gola nera. Basamento Groove in metallo nero.

Shake sideboard in wood veneer with Tempo slat in Noce CN finish, black groove and top in glossy lacquered glass Nero finish. Groove base in black metal.





16th STORY

MADIA GINGER

Il rigore geometrico ispira lo stile della madia Ginger, partendo dalla struttura, caratterizzata da linee pure e nitide, per finire con le accurate incisioni lineari, in continuità sulle diverse superfici.

The geometric rigor inspires the style of the Ginger sideboard, starting from the structure, characterized by pure and clear lines, ending with the accurate linear engravings, in continuity on the different surfaces.



MADIA GINGER

Madia Ginger costituita da struttura interna in bilaminato finitura Noce NT. Ante a sinistra Evans air in alluminio bronzo con cerniere affogate sul fondo e cappello e vetro trasparente fumè. Ante a destra legno impiallacciato con doga Always finitura Frassino BL. Vaso superiore in laccato opaco finitura Bronzo e tappetino in eco-pelle Vintage finitura Pandora 10. Basamento Misty in alluminio anodizzato bronzo.

Ginger sideboard made up of an internal structure in bilaminate Noce NT finish. Evans air doors in bronze aluminum with drowned hinges on the bottom and top and smoked transparent glass. Doors in wood veneer with Always slat in Frassino BL finish. Upper tray in matt lacquered Bronze finish and mat in Vintage eco-leather Pandora 10 finish. Misty base in bronze anodized aluminum.



126



17th STORY

MADIA BARON

Madia Baron costituita da struttura interna in bilaminato finitura Mandorlo. Ante Evans air in alluminio bronzo con cerniere affogate sul fondo e cappello e vetro fumè con serigrafia seamless. Vassoio superiore in laccato opaco finitura Bronzo e tappetino in eco-pelle Vintage finitura Pandora 10. Basamento Misty in alluminio anodizzato bronzo.

Baron sideboard made of an internal structure in bilaminated Mandorlo finish. Evans air doors in bronze aluminum with drowned hinges on the bottom and top and smoked glass with seamless serigraphy. Upper tray in matt lacquered Bronze finish and mat in Vintage eco-leather Pandora 10 finish. Misty base in bronze anodized aluminum.

127





18th STORY

MADIA ELLINGTON AND BASE

Madia Ellington and Base in laccato opaco finitura Grigio LV, top in legno impiallacciato finitura Noce CN. Basamento Groove in metallo nero.

Ellington and Base sideboard in matt lacquered Grigio LV finish, top in wood veneer Noce CN finish. Groove base in black metal.





19th STORY

MADIA QUEEN

Una calda atmosfera domina la scena ed esalta i riflessi della madia Queen in vetro e legno. Toni che rimandano ad atmosfere del passato per dar luogo ad uno spazio conviviale in cui immergersi.

A warm atmosphere dominates the scene and enhances the reflections of the Queen sideboard in glass and wood. Tones that refer to atmospheres of the past to create a convivial space to live in.



MADIA QUEEN

Madia Queen costituita da struttura interna in bilaminato finitura Mandorlo. Ante centrali Evans air in alluminio bronzo con cerniere affogate sul fondo e cappello e vetro trasparente fumè. Ante ai lati in legno impiallacciato con doga Always finitura Rovere TC. Top in eco-pelle Vintage finitura Pandora 09. Basamento Groove in metallo bronzo.

Queen sideboard made up of an internal structure in bilaminate Mandorlo finish. Evans air central doors in bronze aluminum with drowned hinges on the bottom and top and fumè transparent glass. Side doors in wood veneer with Always slat in Rovere TC finish. Top in Vintage eco-leather Pandora 09 finish. Groove base in bronze metal.





20th STORY

MADIA BILLIE

Madia Billie in laccato opaco con dogia Always finitura Lampone, vano a giorno in legno impiallacciato finitura Rovere TC. Basamento Floating trasparente.

Billie sideboard in matt lacquered with Always slat Lampone finish, open space unit in wood veneer Rovere TC finish. Floating transparent base.



TECHNICAL DRAWINGS

LOVIE MADIA / SIDEBORD

Basamento in metacrilato trasparente, ante laccato lucido. Top in gres.
Transparent methacrylate basement, glossy lacquered doors. Gres top.

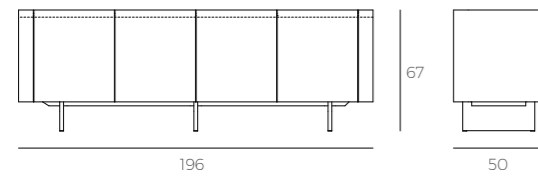
**WES MADIA / SIDEBORD**

Basamento in metallo, ante vetro Evans air.
Metal basement, Evans air glass doors.

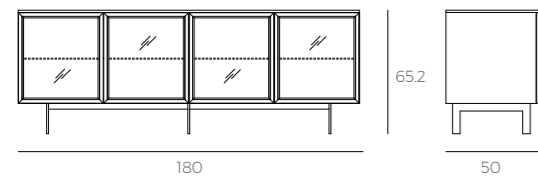
**JACKIE MADIA / SIDEBORD**

Basamento in metacrilato trasparente, ante laccato lucido e vano a giorno centrale laccato opaco. Top in tinta.
Transparent methacrylate basement, glossy lacquered doors and matt lacquered central open space unit. Matching top.

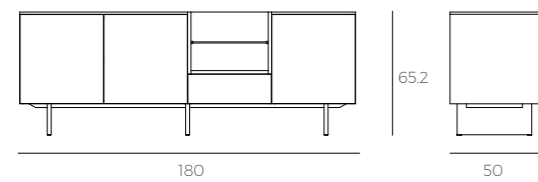
**DEE DEE MADIA / SIDEBORD**

Basamento in bilaminato, ante laccato opaco Tempo, fianchi laccato opaco. Top in bilaminato ed eco-pelle.
Bilaminated basement, Tempo matt lacquered doors, matt lacquered side panels. Top in bilaminated and eco-leather.

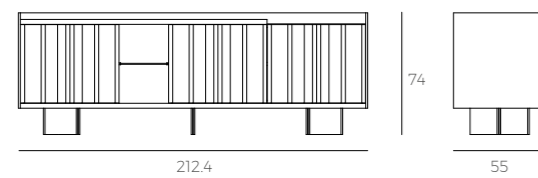
**DEE DEE S MADIA / SIDEBORD**

Basamento e fianchi laccato opaco, ante laccato opaco Tempo. Top in vetro.
Matt lacquered basement and side panels, Tempo matt lacquered doors. Glass top.

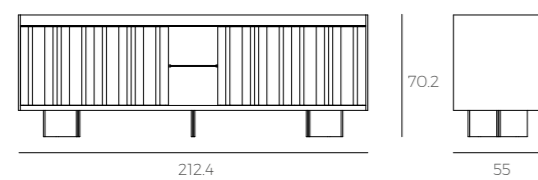
**SHAKE MADIA / SIDEBORD**

Basamento in metallo, ante e fianchi in legno Tempo. Top in vetro.
Metal basement, doors with groove and side panes in wood veneer Tempo. Top in glass.

**GINGER MADIA / SIDEBORD**

Basamento in alluminio, ante vetro Evans air e ante in legno Always. Vassoio laccato come il basamento.
Aluminum basement, Evans air glass doors and Always wood veneer doors. Tray lacquered same as basement.

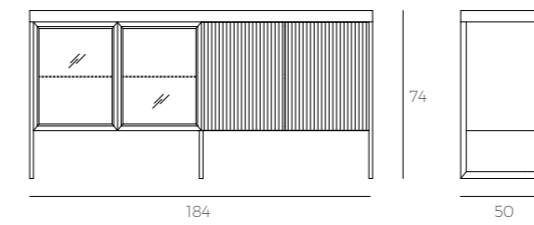
**ELLINGTON AND BASE MADIA / SIDEBORD**

Basamento in metallo, ante laccato opaco Always. Top e vano a giorno in legno.
Metal basement, Always matt lacquered doors. Top and open space unit in wood veneer.

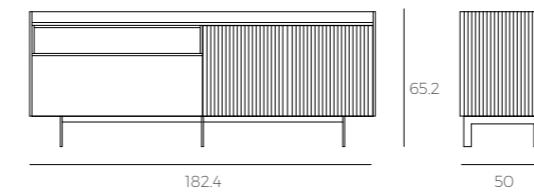
**QUEEN MADIA / SIDEBORD**

Basamento in metallo, ante vetro Evans air e ante in legno Always. Tappetino in eco-pelle.
Metal basement, Evans air glass and wood veneer Always doors. Mat in eco-leather.

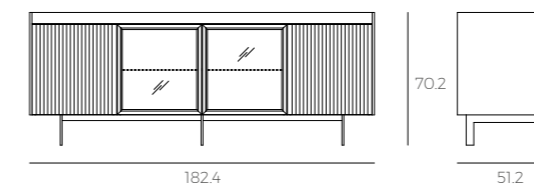
**BILLIE MADIA / SIDEBORD**

Basamento in metacrilato trasparente, ante laccato opaco Always e vano a giorno centrale. Top in tinta.
Transparent methacrylate basement, Always matt lacquered doors and central open space unit. Matching top.

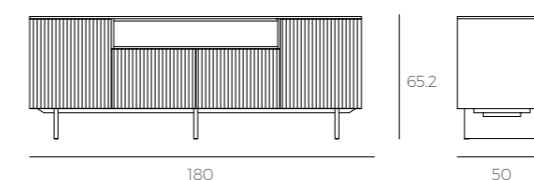

BARON VETRINA / GLASS CUPBOARD

Basamento in alluminio, ante vetro Evans air. Vassoio laccato come il basamento.
Aluminum basement, Evans air glass doors. Tray lacquered same as basement.

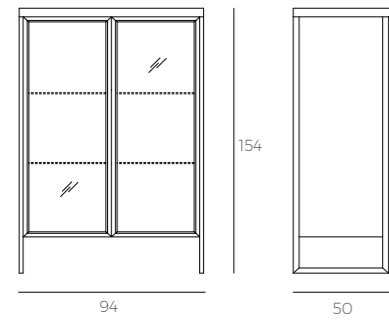
**REBUS SPECCHIO / MIRROR**

Telaio in alluminio e specchio illuminato 3 lati.
Aluminum frame and mirror with 3 sides led lighting.

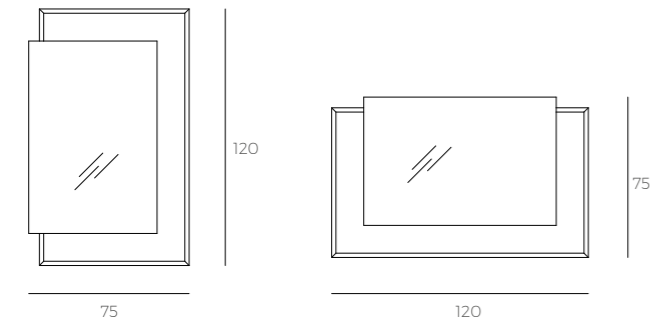
**BIG MAMA SEDIA / CHAIR**

Struttura in legno, seduta in tessuto Roma o velluto Viky.
Structure in wood, seat in Roma fabric or Viky velvet.

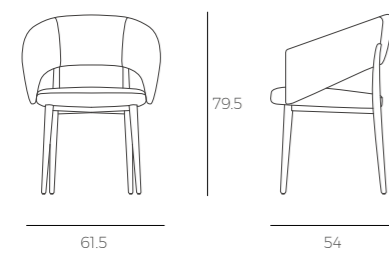
**LADY DAY SEDIA / CHAIR**

Struttura in legno, seduta in tessuto Roma o velluto Viky.
Structure in wood, seat in Roma fabric or Viky velvet.

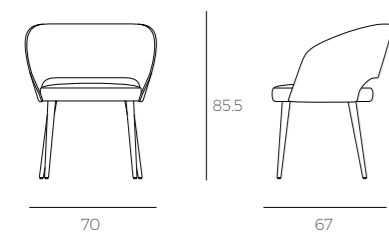
**YASS TAVOLO / TABLE**

Basamento in metallo laccato opaco, top in MDF laccato opaco o gres.
Base in matt lacquered metal, top in MDF matt lacquered or gres.

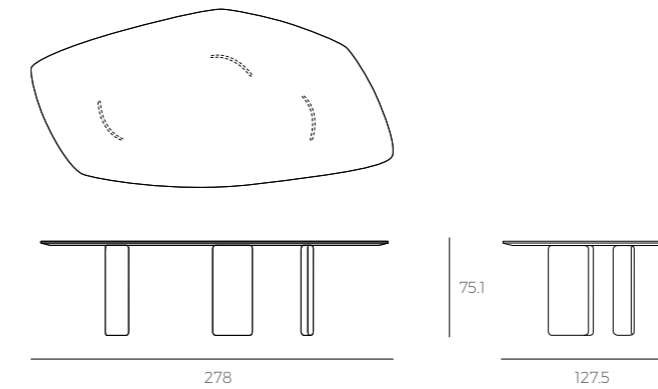
**YASS TAVOLO / TABLE**

Basamento in metallo laccato opaco, top in MDF laccato opaco o gres.
Base in matt lacquered metal, top in MDF matt lacquered or gres.

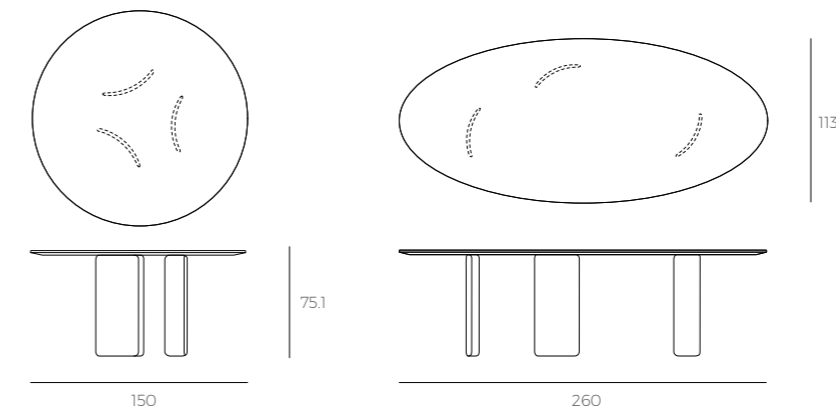
**JACO COFFEE TABLE**

Struttura interna e fianchi esterni in bilaminato o laccato. Vassoio superiore laccato opaco con tappetino in eco-pelle.
Internal and external structure in bilaminate or lacquered. Matt lacquered upper tray with eco-leather mat.

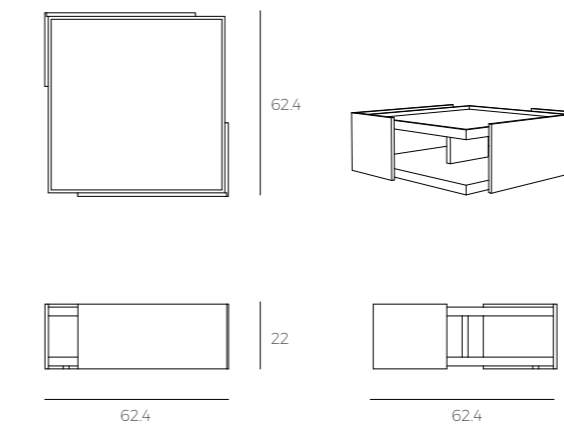

Art direction
Mama Studio

Graphic design
Mama Studio

Product design
Mama Studio
Giuseppe D'Ecclesia

Copy
Mama Studio

Render
Matic animation
Francesca Di Giovanni

Color separation
Francesca Di Giovanni

Print
Sincromia

Thanks to
MM Lampadari

2023

GUZZINI & FONTANA PROJECTS S.R.L.
Via Grecia - Palazzese, Roseto degli Abruzzi
64026 (TE) Italy
Cod. Fisc. / P.IVA 01927160679
Tel. +39 085 8069006
info@guzziniefontana.it



The mark of
responsible forestry
FSC® C136814



Guzzini & Fontana project s.r.l. può apportare ai prodotti modifiche, migliorie tecniche, annullamenti di articoli di fine serie che siano ritenuti opportuni, in qualsiasi momento e senza alcun preavviso.
Guzzini & Fontana project s.r.l. reserves the right to modify its products, apply technical improvements or cancel end-of-series articles when deemed opportune and at any time, without prior notice.