



Percorsi Privileged
privilegiati paths
dell'of
acquawater
Collection





Glass Design è un'eccellenza Italiana nella produzione e nel design di lavabi e complementi d'arredo bagno. ***Glass Design** is an Italian excellence in the production and design of bathroom washbasins and interior decoration furnishings.*

Situata a Vinci, cuore della Toscana e città di "Leonardo da Vinci", Glass Design è stata fondata nel 1984 dalla famiglia Borsellini, dopo una pluriennale esperienza nella manifattura del vetro artistico.

Located in Vinci, in the heart of Tuscany and native town of "Leonardo da Vinci", Glass Design was founded in 1984 by the Borsellini family, further to a long tradition in manufacturing artistic glass.

Utilizzando materiali tecnologicamente avanzati, come il Silicio o l'Inox e, lavorando ad arte su materiali tradizionali, come il cristallo molato o il vetro artistico, Glass Design contribuisce alla creazione di un nuovo stile dove l'accessorio, curato nei minimi dettagli, diventa il soggetto principale dell'ambiente, un vero prodotto "moda", apprezzato nel mondo ed esportato in più di 60 paesi.

Both by using technologically advanced materials such as stainless steel or silicone, and by working in an artistic way with traditional materials like the formed 24%pb crystal and the artisan glass, the company Glass Design contributes to the creation of a new style, where even the accessory is addressed in all details, becoming the main subject of the environment, a true "fashion" product, highly appreciated in the world and exported to more than 60 countries.

Oltre 200 artigiani Toscani e una quindicina di vetrai muranesi appartengono alla filiera produttiva aziendale, permettendo di adattare ogni prodotto ad esigenze e richieste specifiche del cliente, con infinite personalizzazioni realizzando così, prodotti unici ed esclusivi.

Over 200 Tuscan artisans and more than 15 glassmakers of Murano work within the company's production chain, enabling the customization of each product to suit individual needs and specific requirements, in order to create unique and exclusive products.

Indice

Index

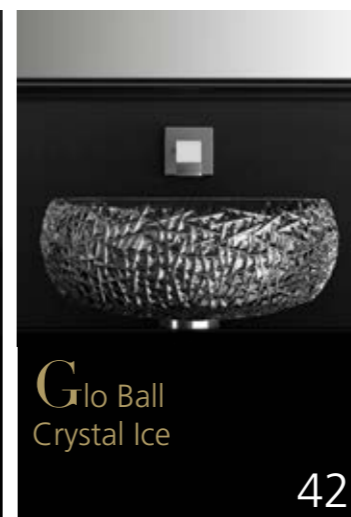
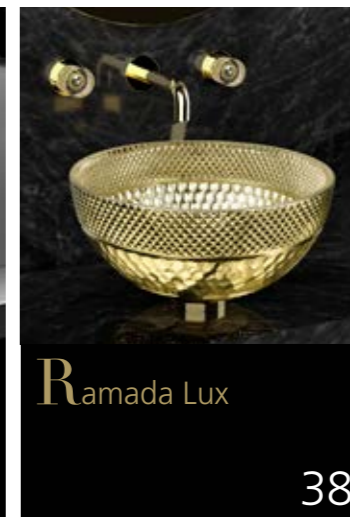
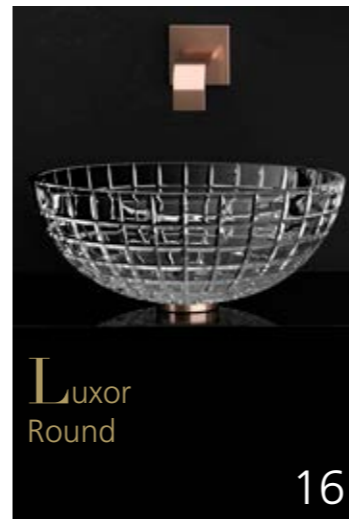



Glo Ball
Murano
50



Laguna Blue
52



Laguna Night
54



Laguna Oro
55



Air Calacatta
78

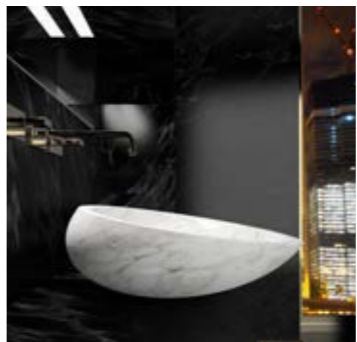

Kool Max Calacatta
80



Kool
Kool Max
Kool XI
84



Kool Oversize
88

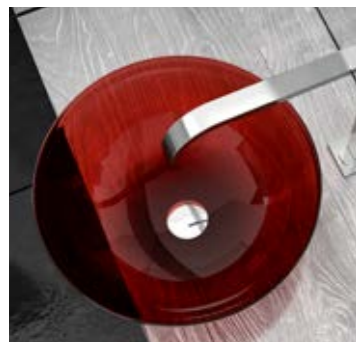

Laguna Red
56



Laguna
Vintage
57



Canale
58

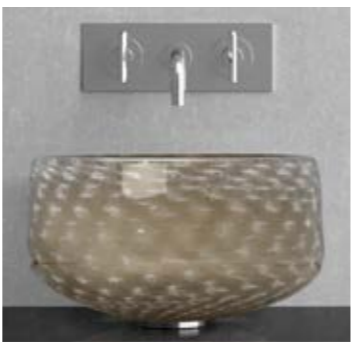

Ottico
59



Air
90



Infinity Over
92



Collina
94



Ala
96



Calla Black
60

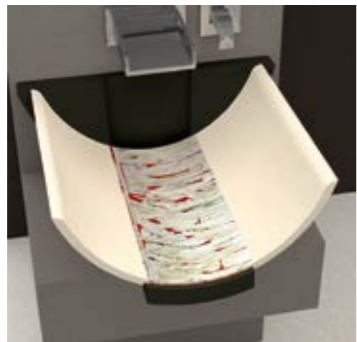

Calla
62



Arte Uno
64



Arte Due
66



Play
98



Net
100



Stone
102



Cocoon Metal
106



Arte Tre
68



Arte Quattro
70



Gondola
72



Carnival
74



Cocoon Lux
108



Cocoon Materic
109



Mosaic
110



Circus
112



Circus Travertino

116



Oval Travertino

117



Rapolano

118



Roma

120



Exté Lux

150



Exté

152



Nek Lux

154



Nek

156



Flower

124

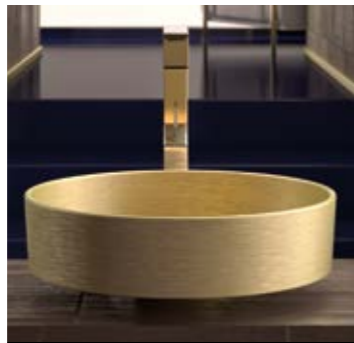

Rho Metal

128



Rho Lux

130

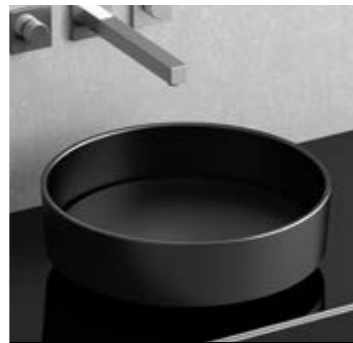

Rho Vision

132



Ares

158



Round

160



Vogue

162



Norite

164



Rho Starlight

134



Four Starlight

135



Four Lux

136



Four Vision

138

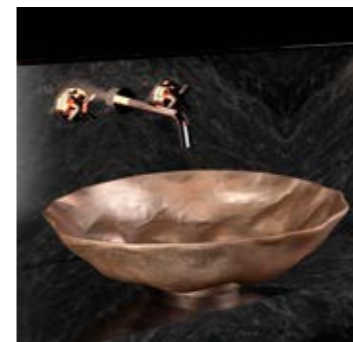

Reverse

166



Oxidren

168



Metropole Katino

172



Metropole Flou

174



Blade Vision

140



Infinity Colour

142



Infinity Starlight

144



Open

146



Metropole Round

175



Tekno Materic

176



Tekno Metal

178



Tekno Lux

180



Graffiti

182



Venice

184



Mosaic Anniversary

186



Mosaic Anniversary
SOTTO

188



Bamboo Katino

212



Mistral LUX

214



City LUX

216



Arabesque LUX

218



Luna

190



Luna Katino

192



Gala

194



Kalahari

196



Mito

222



Glo Ball

224



De Coste

226



Barchetta

230



Xeny

198



Flare

200



Filigrana

202



Flare Tech

203



Gum

232



Mode Lux

236



Mode Classic

238



Polo

240

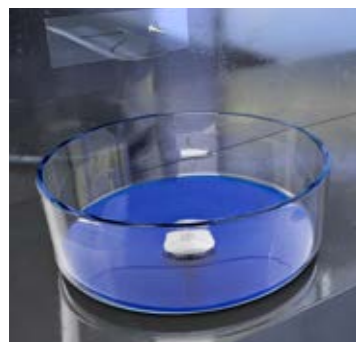

Drop Katino

204

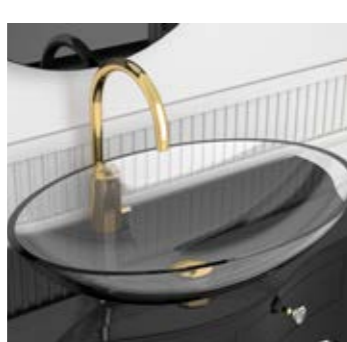

Flo

208



Soffio

210



Globo

211

Accessori bagno
Bath accessories

continua / continues

242

Accessori bagno
Bath accessories



Valentino

244



Tonda

246



Venice

257



Graffiti

257



Glamour

258



Keiss

248



Navy

249



Metropole

250



Quadra

259



Icissance

260



Drop essence

262



Colori

252



Colori Lux

254

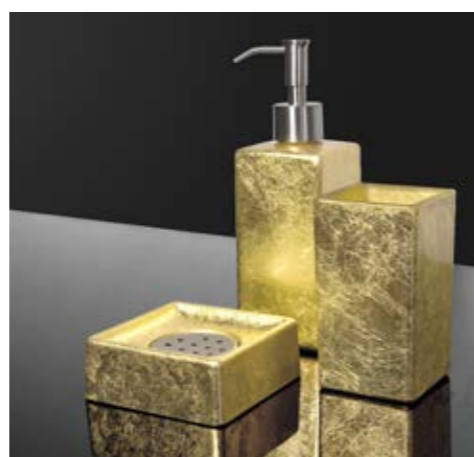

Luxury

256



Special One

264



Specifiche
data sheet

270



Materiali
materials

344

 Cristallo[®]
DE' MEDICI
Pb 24%

Dalle più antiche e nobili arti vetrarie.
From the ancient and noble glass arts.

Collezioni esclusive, realizzate in cristallo purissimo al 24% pb.
Si tratta di prodotti raffinatissimi, soffiati a bocca e molati a pietra con
abilità, dai nostri maestri secondo le più antiche e nobili arti vetrarie.
Nessuna macchina, nessuna tecnologia, ma solo prodotti d'arte,
classici, contemporanei ... futuristici.

Exclusive collections created from pure crystal with 24% lead content.
These utmost refined products are mouth-blown and bevelled in stone
by our master artists according to the most ancient and noble glass
arts. Neither machines nor technology are employed in the process,
resulting in classical, contemporary or futuristic art products.



“Il Cristallo: collezioni d'arte”

“The Crystal: art collections”



Luxor

Round

Cristallo
DE MEDICI
Pb 24%

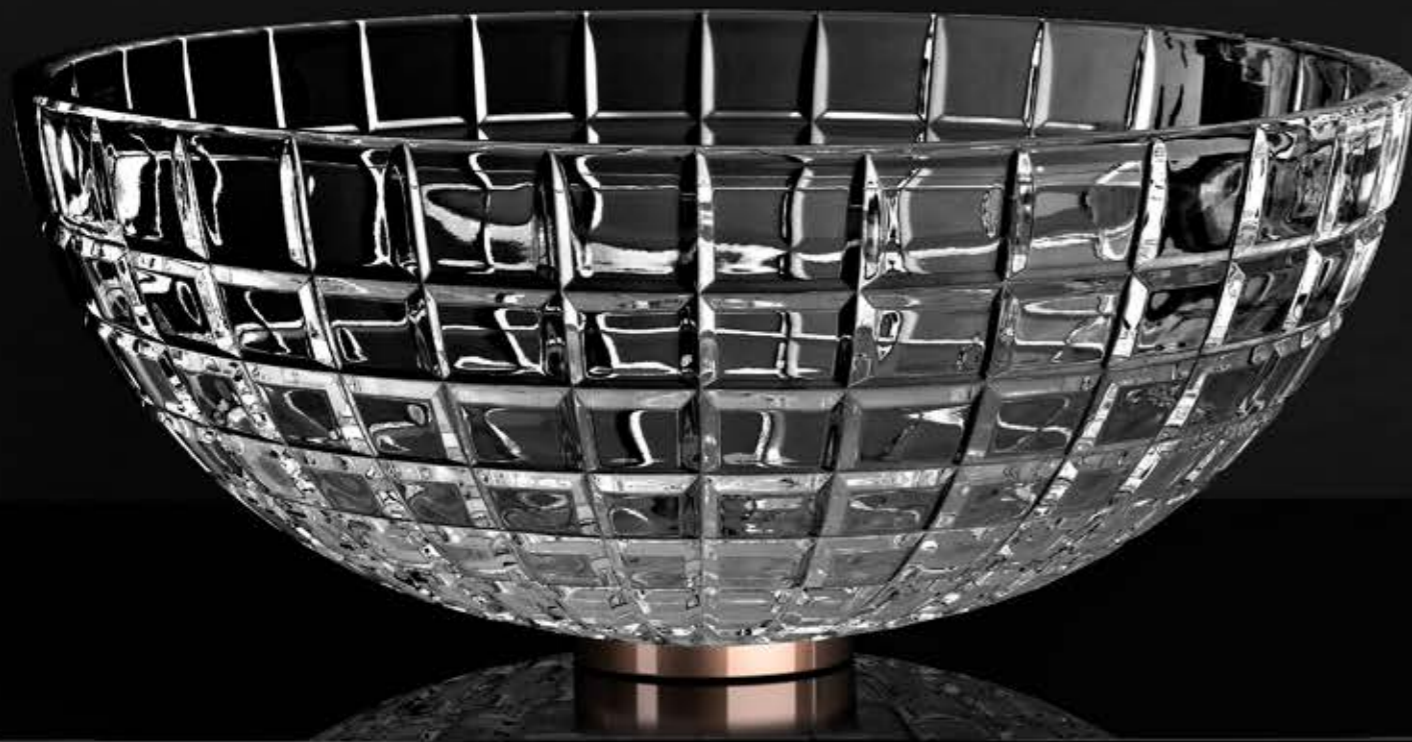

LUXOR ROUND code **LUXORROT01F10**
manopole per rubinetto in cristallo trasparente - clear crystal faucet handles - GLAMOROUS TUNING collection



brevettato / patented

Villa

Cristallo
DE MEDICI
Pb 24%



18

VILLA code VILLAT01F4



19

design by **Studio ARIUS**



brevettato / patented

Collier

Cristallo
DE MEDICI
Pb 24%



COLLIER code COLLIERT30F4



Ice Oval

Cristallo
DE MEDICI
Pb 24%

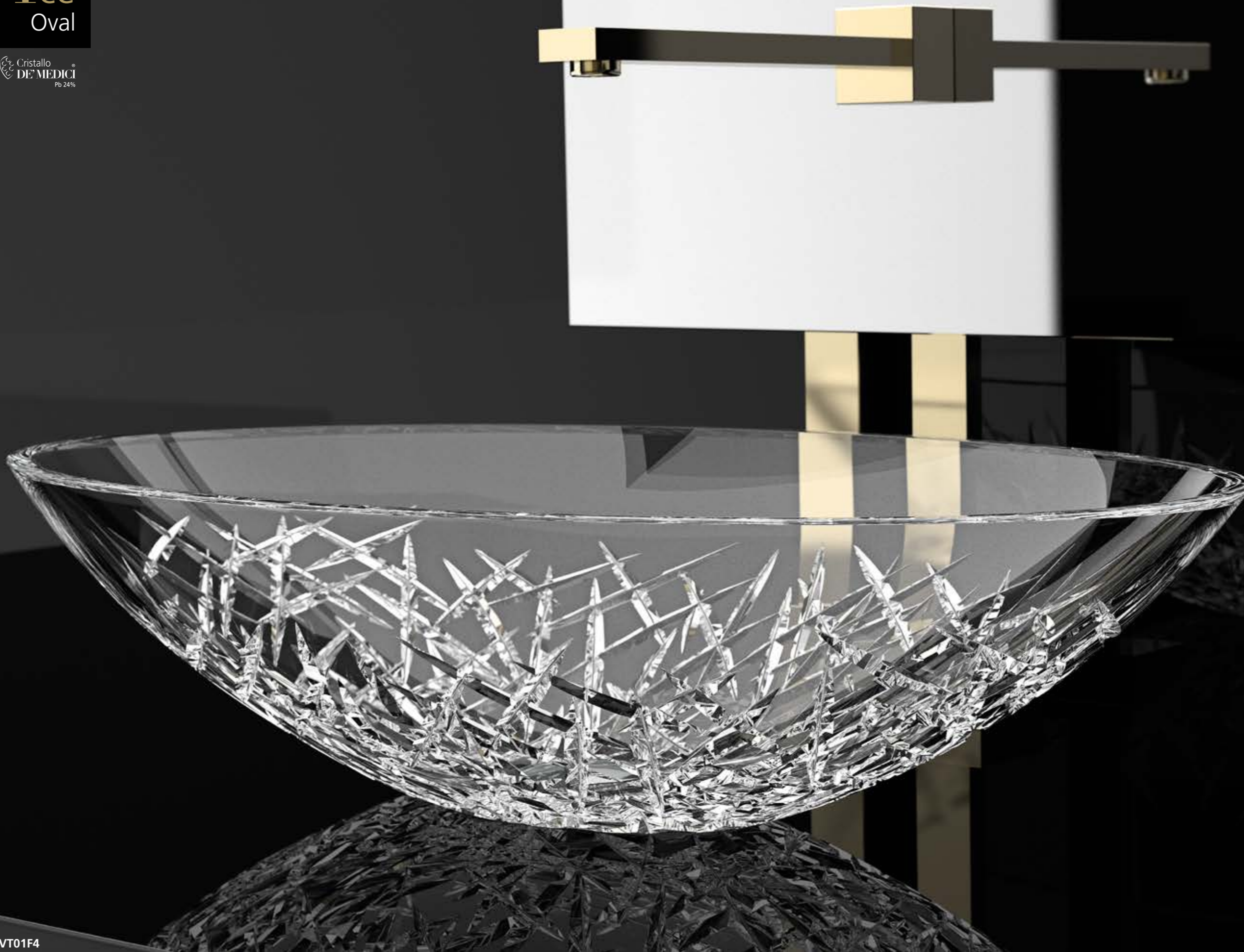

ICE OVAL code ICEOVT01F4



brevettato / patented

design by **Studio ARIUS**

Ice Oval Lux

Cristallo
DE MEDICI
Pb 24%



24

25

ICE OVAL LUX code **ICEOVGDF3**



brevettato / patented



brevettato / patented

design by **Studio ARIUS**

Luxor

Oval

Cristallo
DE MEDICI
Pb 24%

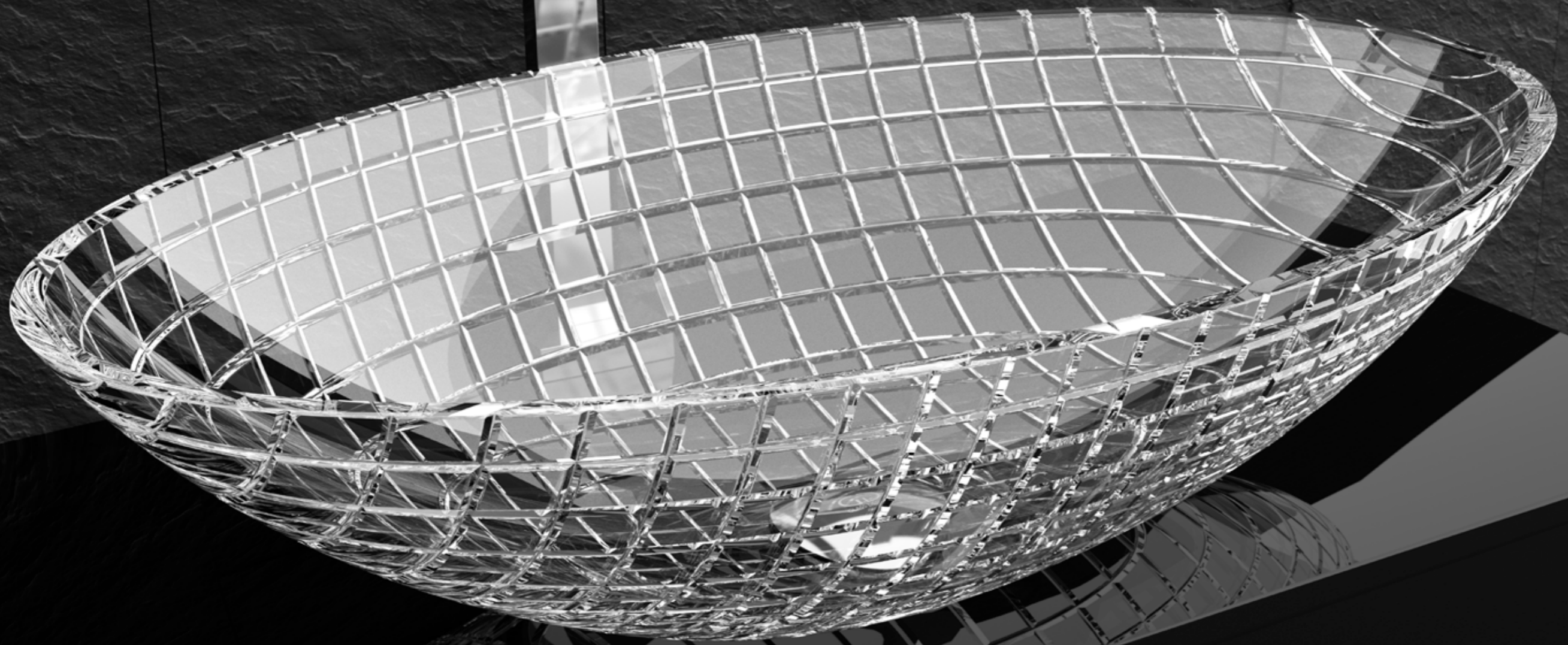

LUXOR OVAL code LUXOROV01F4



brevettato / patented

design by **Studio ARIUS**

Luxor

Oval Blue

Cristallo
DE MEDICI
Pb 24%

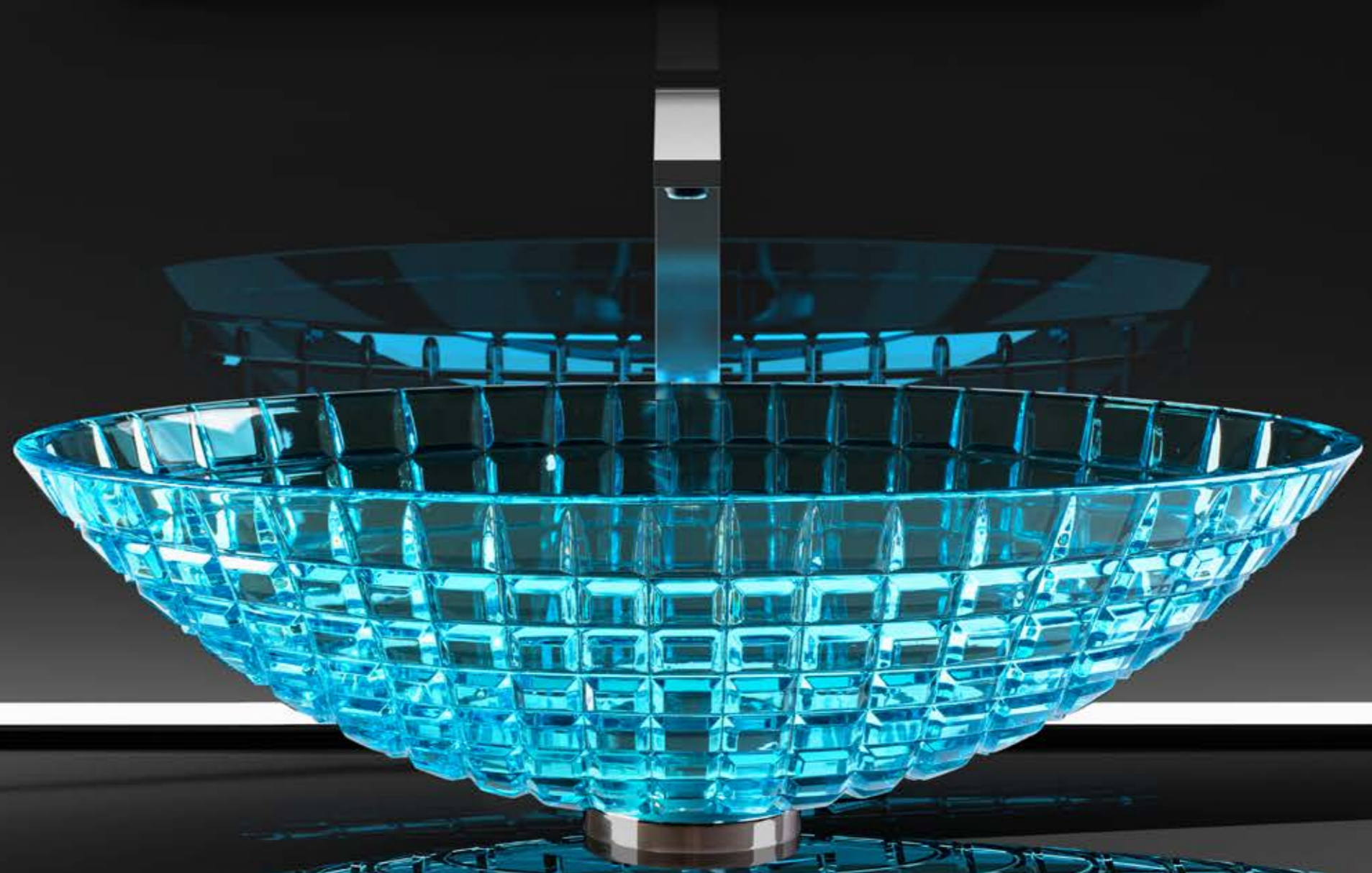

LUXOR OVAL code LUXOROVT20F4



brevettato / patented

design by **Studio ARIUS**

Clivia

Cristallo
DE MEDICI
Pb 24%



CLIVIA code CLIVIAT01



CLIVIA code CLIVIAT35
manopole per rubinetto in cristallo nero - black crystal faucet handles - GLAMOROUS TUNING collection



Chelo

Crystallo
DI MEDICI
Pb 24%



CHELO code CHELOT30



CHELO code CHELOT01



Aqua

Cristallo
DE MEDICI
Pb 24%

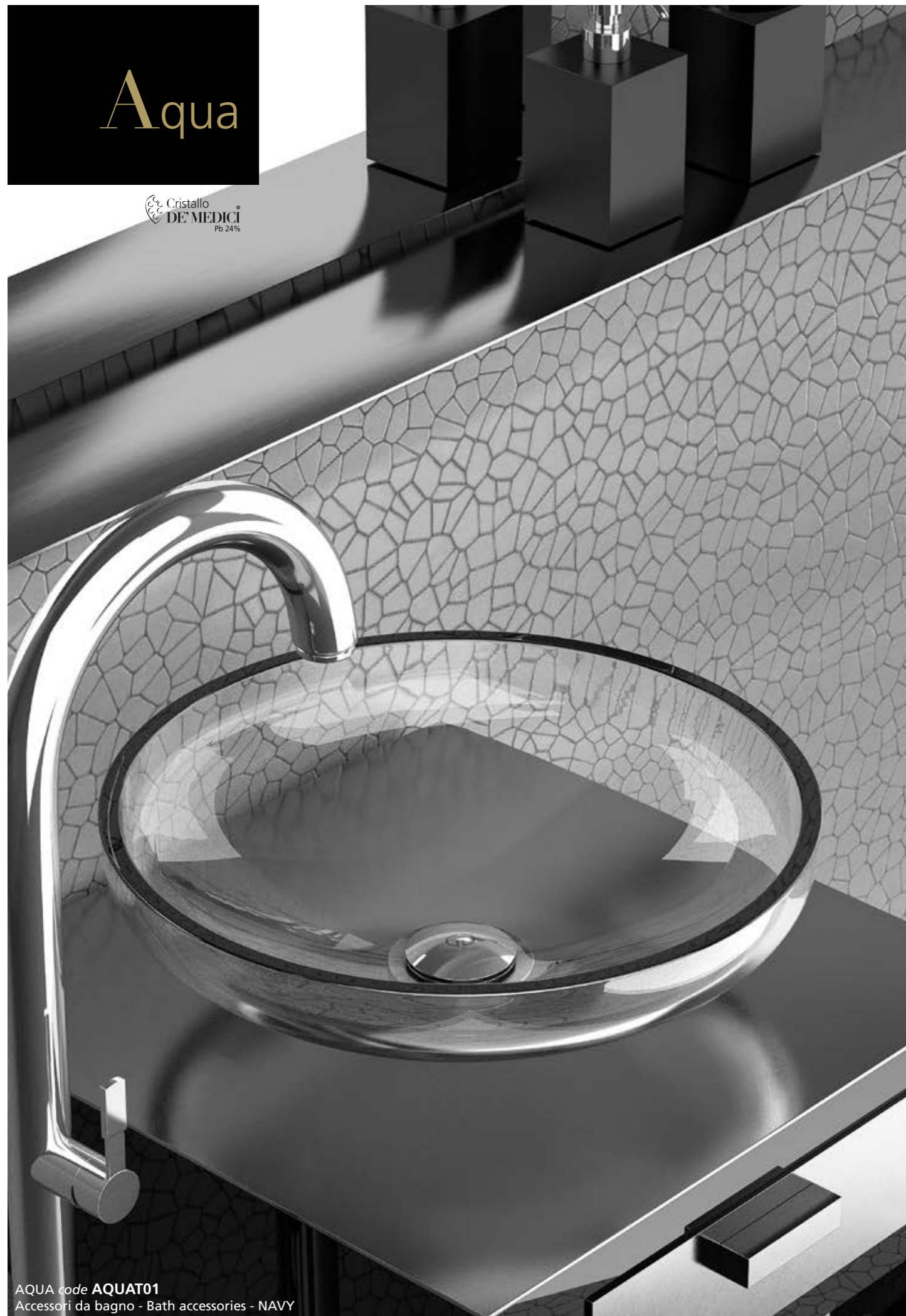

AQUA code **AQUAT01**
Accessori da bagno - Bath accessories - NAVY



AQUA code **AQUAT30**



Moon

Castello
DE MEDICI
Pb 24%



MOON code MOONT01F4



brevettato / patented

design by **Studio ARIUS**

37

36

Ramada

Lux

Cristallo
DE MEDICI
Pb 24%



RAMADA LUX code **RAMADAGDF3**
Manopole per rubinetto in cristallo trasparente/oro - clear/gold crystal faucet handles - **GLAMOROUS TUNING** collection



brevettato / patented

Ramada

Cristallo
DE MEDICI
Pb 24%



RAMADA code **RAMADAT01F4**
Manopole per rubinetto in cristallo trasparente/argento - clear/silver crystal faucet handles - **GLAMOROUS TUNING** collection



brevettato / patented

Moon

Over Ice

Cristallo
DE MEDICI
Pb 24%



You can't see other

MOON OVER ICE code **MOONOVICET01F4**
Manopole per rubinetto in cristallo trasparente - clear crystal faucet handles - **GLAMOROUS TUNING** collection



brevettato / patented

design by **Studio ARIUS**

Glo Ball

Crystal Ice

Cristallo
DE MEDICI
Pb 24%

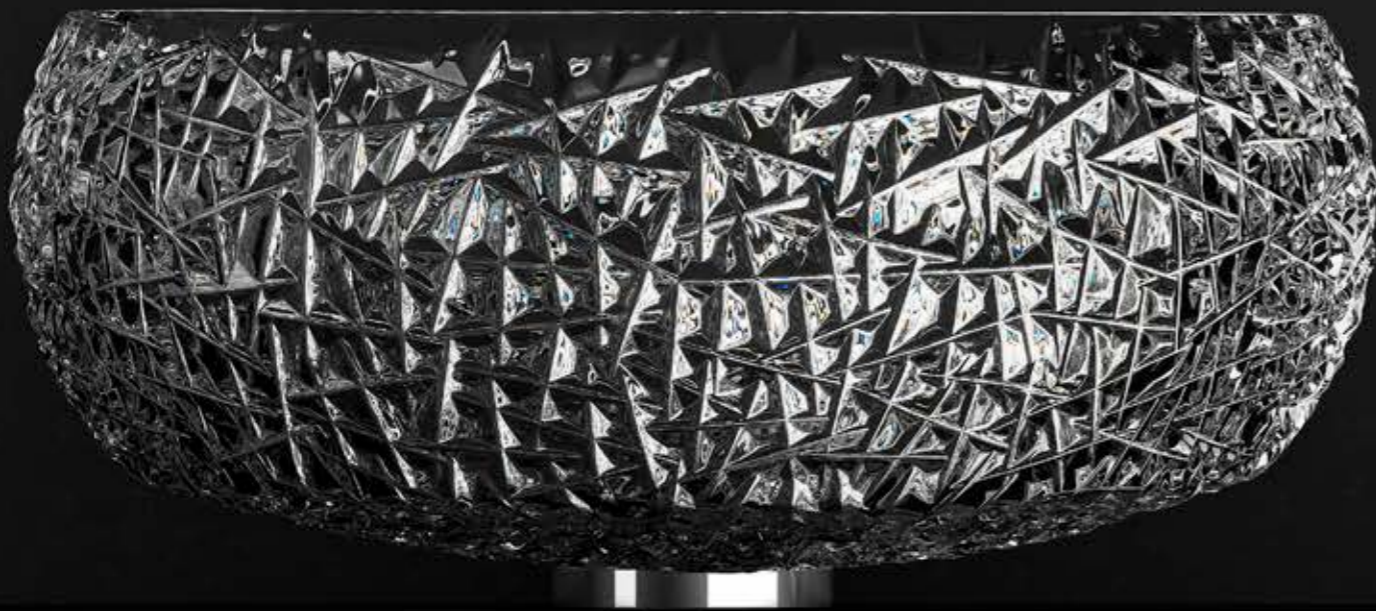

GLOBAL CRYSTAL ICE code **GLOBALICET01F4**
Manopole per rubinetto in cristallo trasparente - clear crystal faucet handles - **GLAMOROUS TUNING** collection



brevettato / patented

design by **Studio ARIUS**

Glo Ball

Crystal Ramada

Cristallo
DE MEDICI
Pb 24%



44

GLOBAL CRYSTAL RAMADA code **GLOBALRAMT01F4**
Manopole per rubinetto in cristallo trasparente - clear crystal faucet handles - **GLAMOROUS TUNING** collection



brevettato / patented

made with
MURANO[®]
glass

Dalla tradizione millenaria un oggetto unico e prestigioso.
Creating masterpieces with artisan traditions.

Il vetro di Murano è da sempre sinonimo di raffinatezza, leggerezza ed eleganza.

I maestri vetrai hanno saputo sviluppare tecniche di lavorazioni privilegiate, nel rispetto della millenaria tradizione che rende il vetro di Murano un prodotto unico, prestigioso e inimitabile.

Murano glass is a synonym for elegance and timelessness.
By combining innovative techniques with traditional artisan workmanship, unique, prestigious and inimitable objects are created.

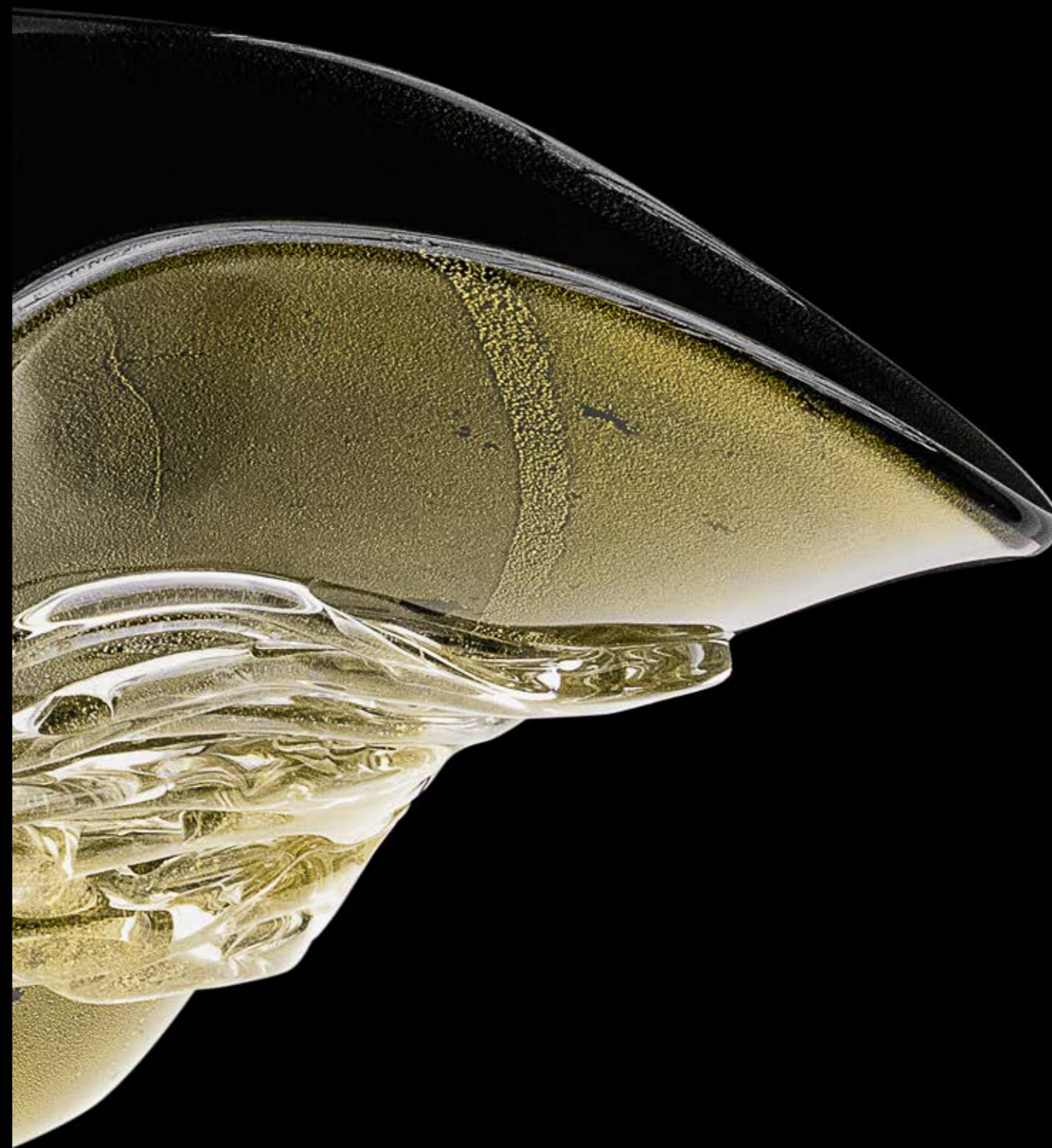

“Il privilegio dell’inimitabile”

“The privilege of individualism”

Isola Small

design by: **Alessandro Lenarda**

made with
MURANO[®]
glass

48

49

ISOLA SMALL code **ISOLASMT36F4**
illuminazione led e trasformatore inclusi - led lighting and transformer included



brevettato / patented

Glo Ball Murano

made with
MURANO[®]
glass



GLO BALL MURANO code **GLOBALMT33F4 - GLOBALMT43F4 - GLOBALMT05F4**



brevettato / patented



GLO BALL MURANO code **GLOBALMT36F4**



brevettato / patented

design by **Studio ARIUS**

Laguna

Blue

made with
MURANO[®]
glass

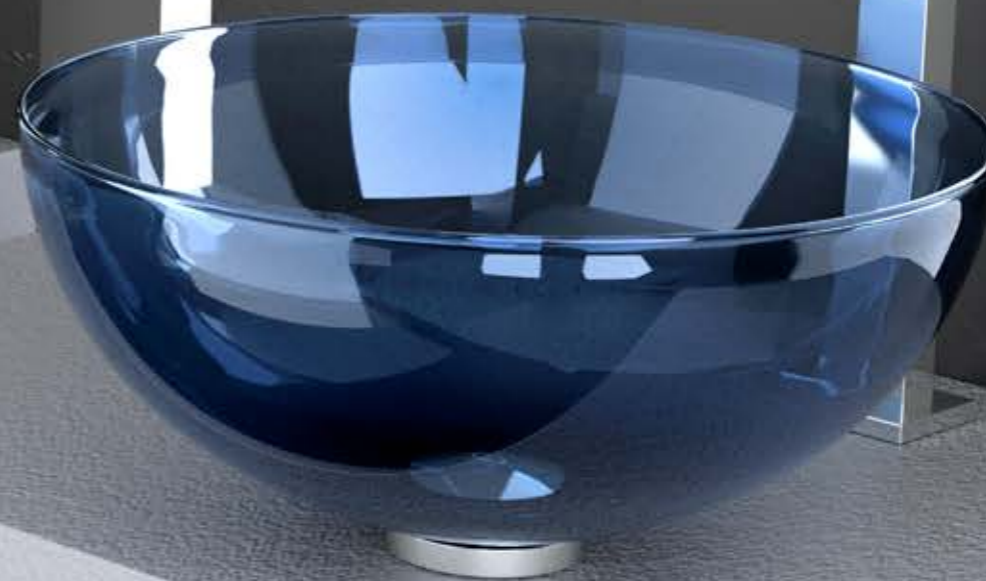

LAGUNA BLUE code LAGUNAT42F4



Laguna Night

made with
MURANO[®]
glass



LAGUNA NIGHT code LAGUNAT33F4



Laguna Oro

made with
MURANO[®]
glass



LAGUNA ORO code LAGUNAGDF3



Laguna

Red

made with
MURANO[®]
glass



LAGUNA RED code LAGUNAT16F4



design by **Studio ARIUS**

Laguna

Vintage

made with
MURANO[®]
glass



LAGUNA VINTAGE code LAGUNAVNF4



design by **Studio ARIUS**

Canale

made with
MURANO[®]
glass

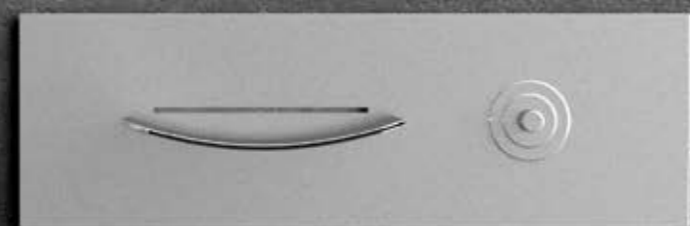

CANALE code CANALEWBF4



design by **Studio ARIUS**

Ottico

made with
MURANO[®]
glass

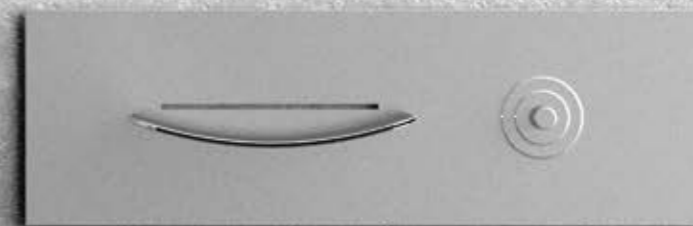

OTTICO code OTTICOGWF4



design by **Studio ARIUS**

Calla Black

made with
MURANO[®]
glass



design

MD
MOGIDDESIGN

CALLA code **CALLABS**

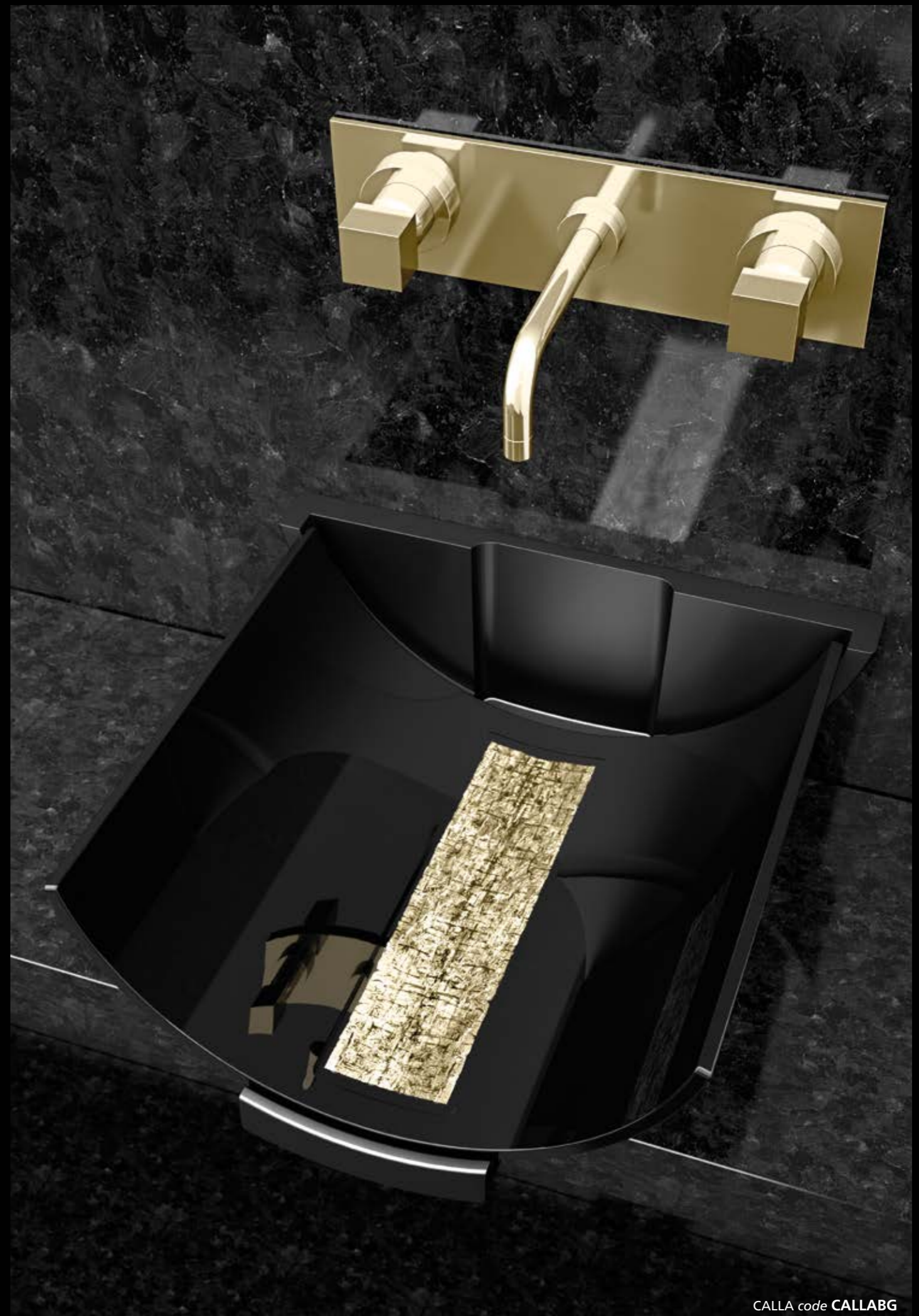

CALLA code **CALLABG**



Calla

made with
MURANO[®]
glass



design by

MD
MOGIDDESIGN

CALLA code **CALLACR01BK**



Arte
UNO

made with
MURANO®
glass

64



ARTE UNO code ARTEUNOFO

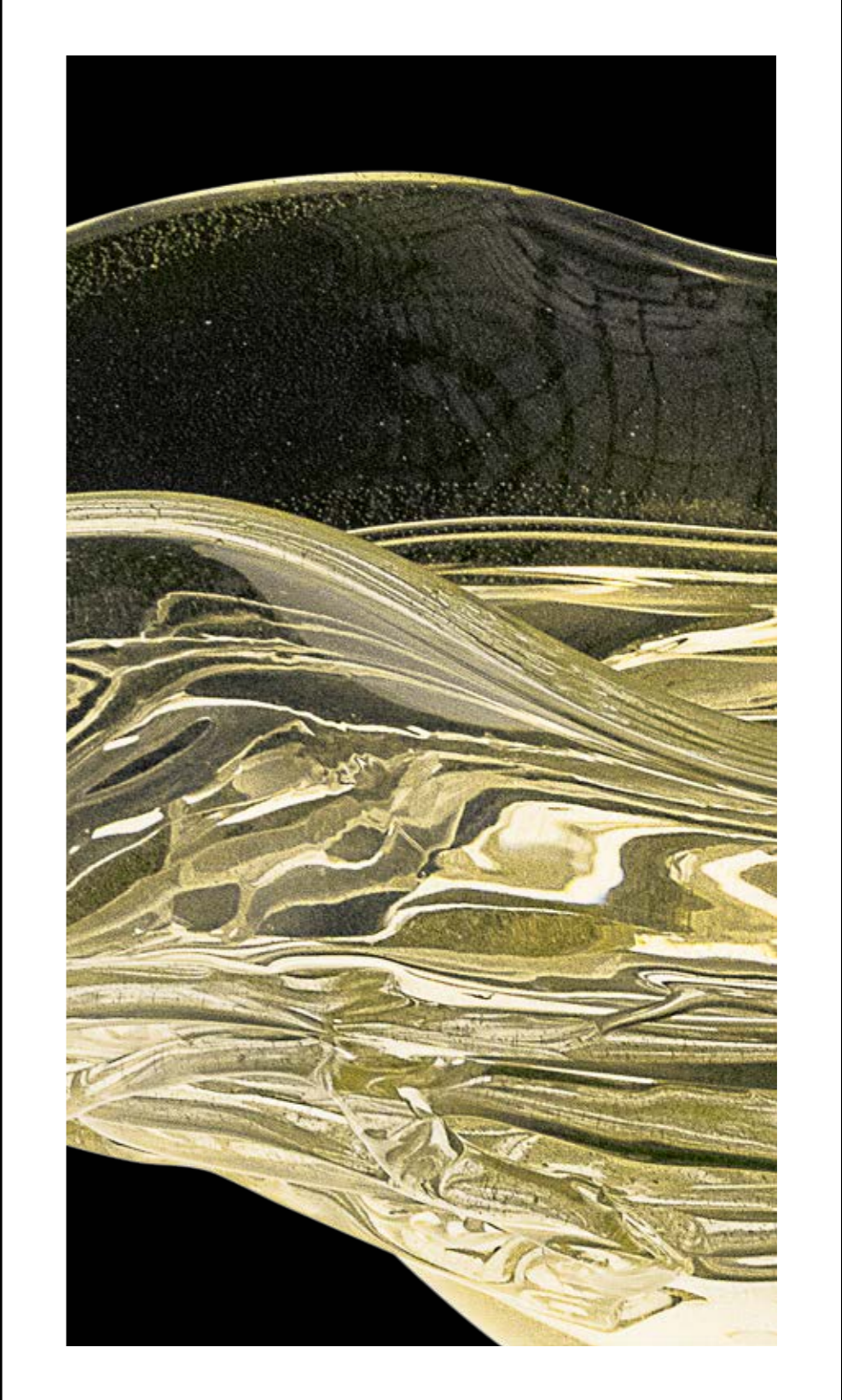

65

design by Studio ARIUS



Arte
DUE

made with
MURANO®
glass



ARTE DUE code ARTEDUENFO

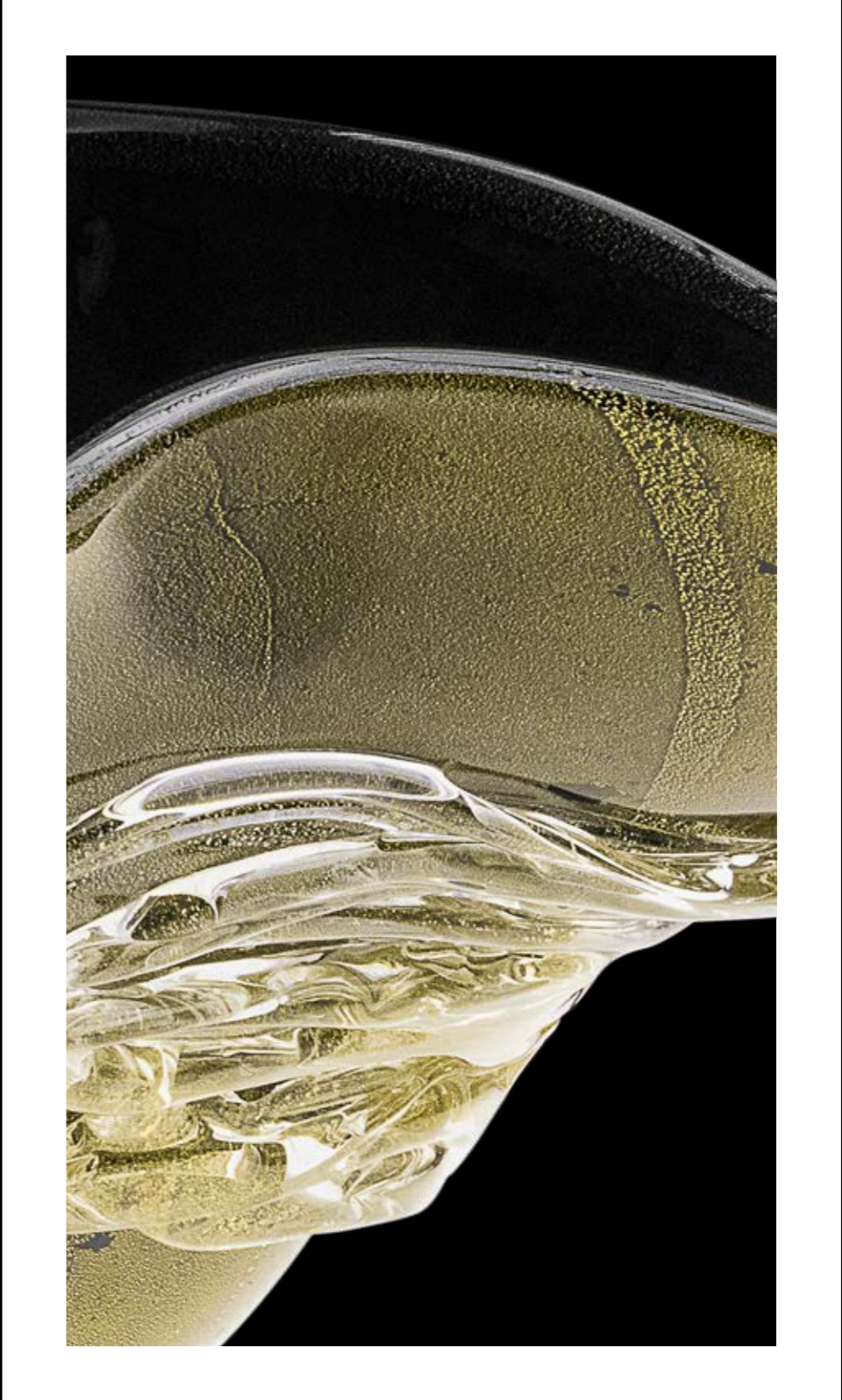

design by **Studio ARIUS**

Arte
TRE

made with
MURANO®
glass



ARTE TRE code ARTETRERD



68

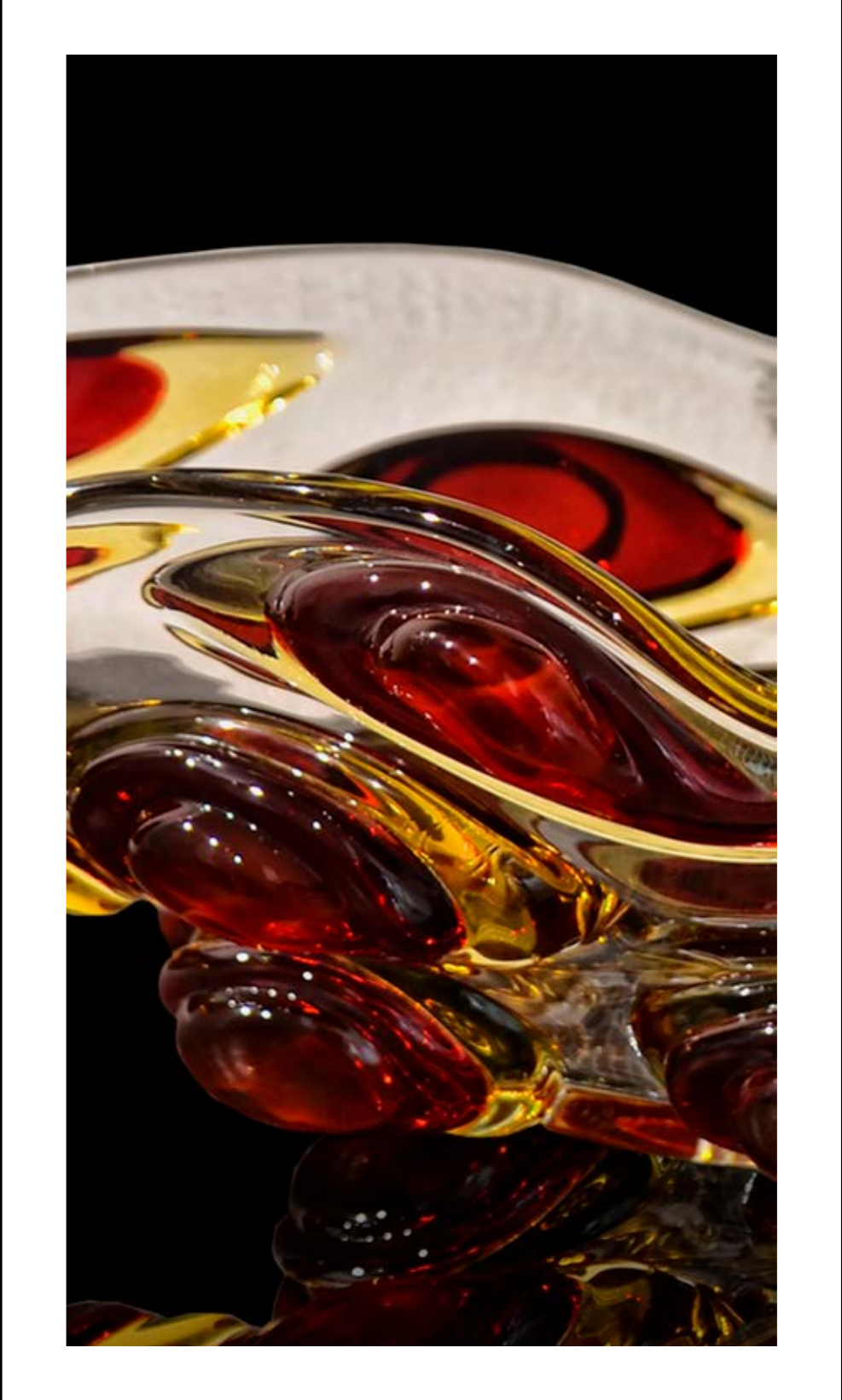

69



design by **Studio ARIUS**

Arte
QUATTRO

made with
MURANO®
glass



ARTE QUATTRO code ARTEQUATTRBB

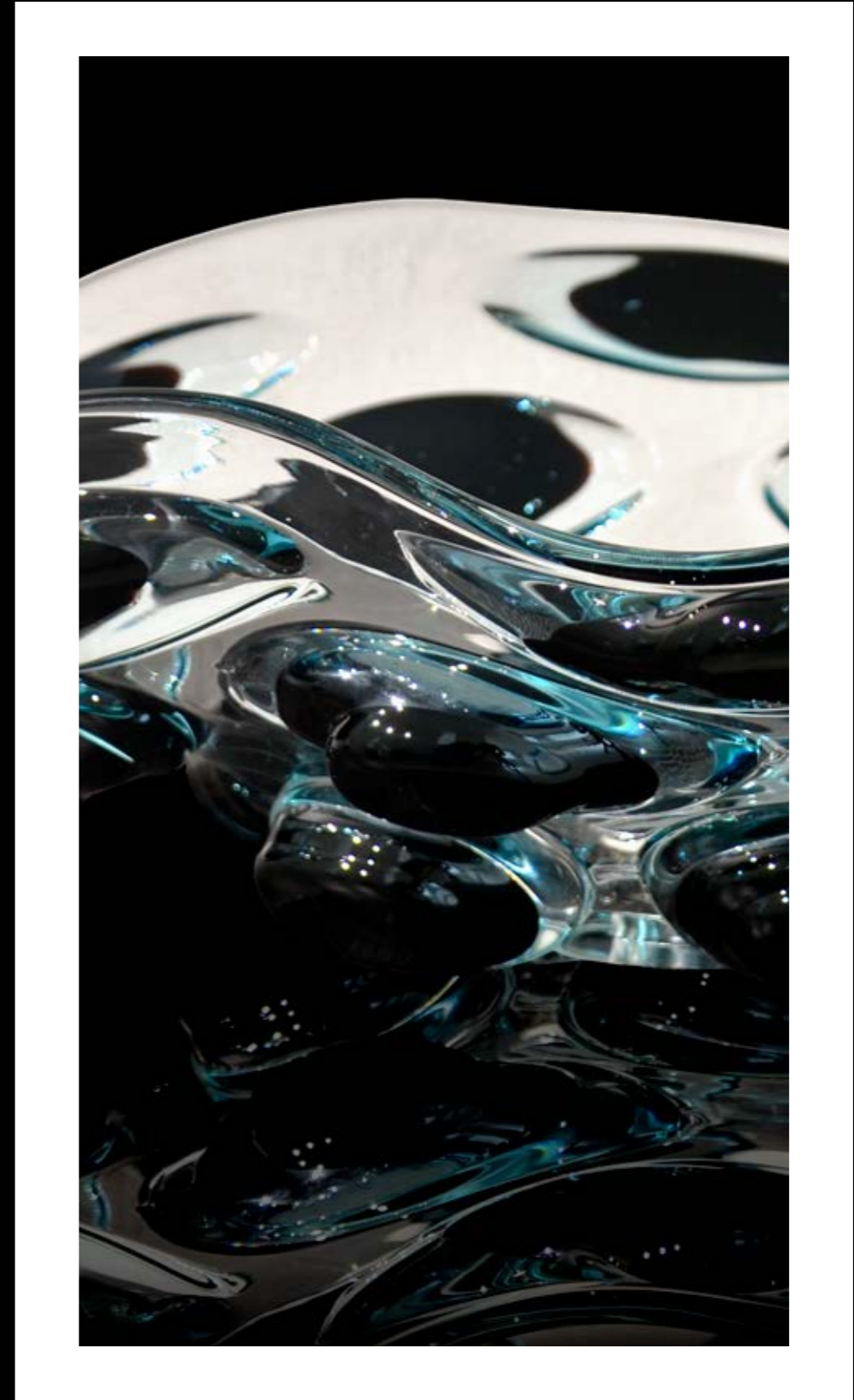

Gondola

made with
MURANO[®]
glass



72



GONDOLA code GONDOLATX01



73

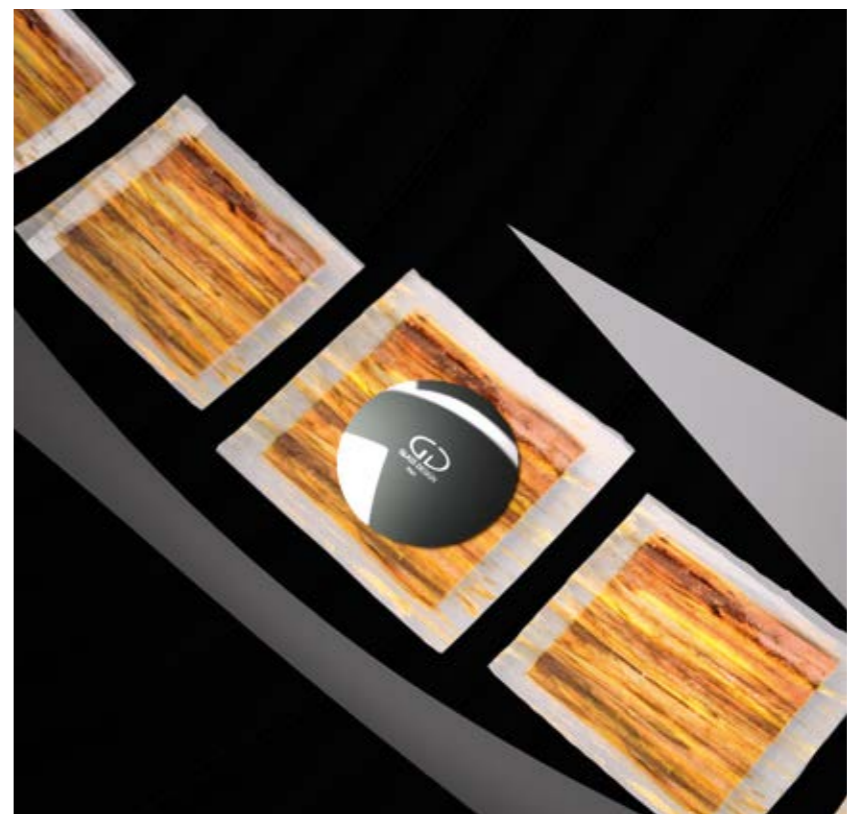

Carnival

made with
MURANO[®]
glass



CARNIVAL code CARNIVALCR01



Marmo CALACATTA

Quando l'arte incontra la natura.
When art meets nature.

Estratto dalle famose cave di Carrara, il marmo Calacatta è il marmo più prezioso e ricercato al mondo. Michelangelo lo usò per realizzare il suo David, capolavoro della scultura rinascimentale, proprio per la particolare bellezza del suo bianco cristallino e delle sue inconfondibili venature sinuose.

Unico tra i marmi, il Calacatta permette di dare libero sfogo al design nella ricerca della sua forma ideale, garantendo lusso estetico unito alle migliori prestazioni di durata e alle nuove tendenze tecnologiche.

Retrieved from the famous quarries of Carrara, Calacatta is the most valuable and sought after marble in the world. Michelangelo chose it to create David, that masterpiece of Renaissance sculpture, precisely because of the particular beauty presented by its white crystalline structure and distinctive veins. Unique among marbles, Calacatta gives free rein to design in the pursuit of its ideal form, ensuring luxurious aesthetics combined with long-lasting performance and an affinity with the latest technological trends.

“La metamorfosi della materia”

“The metamorphosis of matter”

Air

Marmo
CALACATTA



AIR CALACATTA code AIRMARW



brevettato / patented

78



brevettato / patented

design by **Studio ARIUS**

79

Kool
Max



KOOL MAX CALACATTA code KOOLMAXMARW



brevettato / patented



design by **Studio ARIUS**



brevettato / patented

Vetro Freddo®

L' esaltazione della materia attraverso l'anima del suo colore.
A unique material. Expressive colours.

Il Vetro Freddo® è un materiale innovativo, composto da pigmenti vetrosi e resine. La sua caratteristica principale è la sua versatilità nell'adattarsi a qualsiasi tipo di forma. E' l'esaltazione della materia che si esprime attraverso l'anima del suo colore. La natura della sua materia, composta da pigmenti vetrosi e pertanto trasparenti, permette al VetroFreddo® di avere uno dei suoi principali punti di forza, e cioè la possibilità di esprimersi in colori trasparenti, traslucidi od opachi. Nessun limite quindi a livello cromatico e, oltre alla gamma di colori già esistente, è possibile scegliere in base alle proprie esigenze, uno dei numerosi colori presenti nella mazzetta "RAL". Il VetroFreddo® ha una resistenza termica di circa 100°C e può essere lavorato con gli stessi utensili del marmo o del vetro. Tutti gli oggetti in VetroFreddo® si possono lavare con qualsiasi tipo di sapone o detergente neutro non granulare, usando panni o spugne non abrasive. In caso di graffi superficiali, si può ripristinare l'oggetto intervenendo con un panno imbevuto di olio d'oliva o una semplice crema per le mani. In caso di graffi più profondi, è possibile ripristinare con una speciale carta vetro suggerita dal produttore in base al colore o al tipo di oggetto.

VetroFreddo® is an innovative material composed of glass pigments and resin. Its major characteristics are its versatility in adapting itself to any form or shape imaginable. The material's unique characteristics are expressed through the soul of its colour, which can be in clear, semi-transparent or opaque form, due to the material composition of glass pigments. No limits exist in regards to colour. Apart from the existing range of colours, any colour from the "RAL" colour scheme can be chosen. VetroFreddo® is temperature resistant up to approximately 100°C and can be worked with and carved just as marble or glass. All objects designed with the material VetroFreddo® can be cleaned with any type of non-granular soap, using soft sponges or tissues. In case of superficial damage (scratches), the damaged area should gently be rubbed with a sheet soaked in olive oil. In case of deeper scratches or damage, a special replacement glass paper is available from the manufacturer for every colour and type of object.

“Forme e design senza limiti”

“Shapes and design without limits”

Kool

Vetro Freddo



KOOL MAX code KOOLMAXFO



brevettato / patented



KOOL MAX code KOOLMAXFA



brevettato / patented

design by **Studio ARIUS**

Kool

Vetro Freddo®



KOOL MAX code KOOLMAXPO30
Accessori da bagno - Bath accessories KLEISS



brevettato / patented



KOOL XL code KOOLXLPO30



Kool Oversize

VetroFreddo®



KOOL OVERSIZE code KOOLOVERPO30



brevettato / patented



KOOL OVERSIZE code KOOLOVERPO01



KOOL OVERSIZE code KOOLOVERPL34



brevettato / patented

design by **Studio ARIUS**

Air

VetroFreddo®



AIR code AIRPO30



brevettato / patented



AIR code AIRDIPO01



brevettato / patented

design by Studio ARIUS

Infinity Over

VetroFreddo®

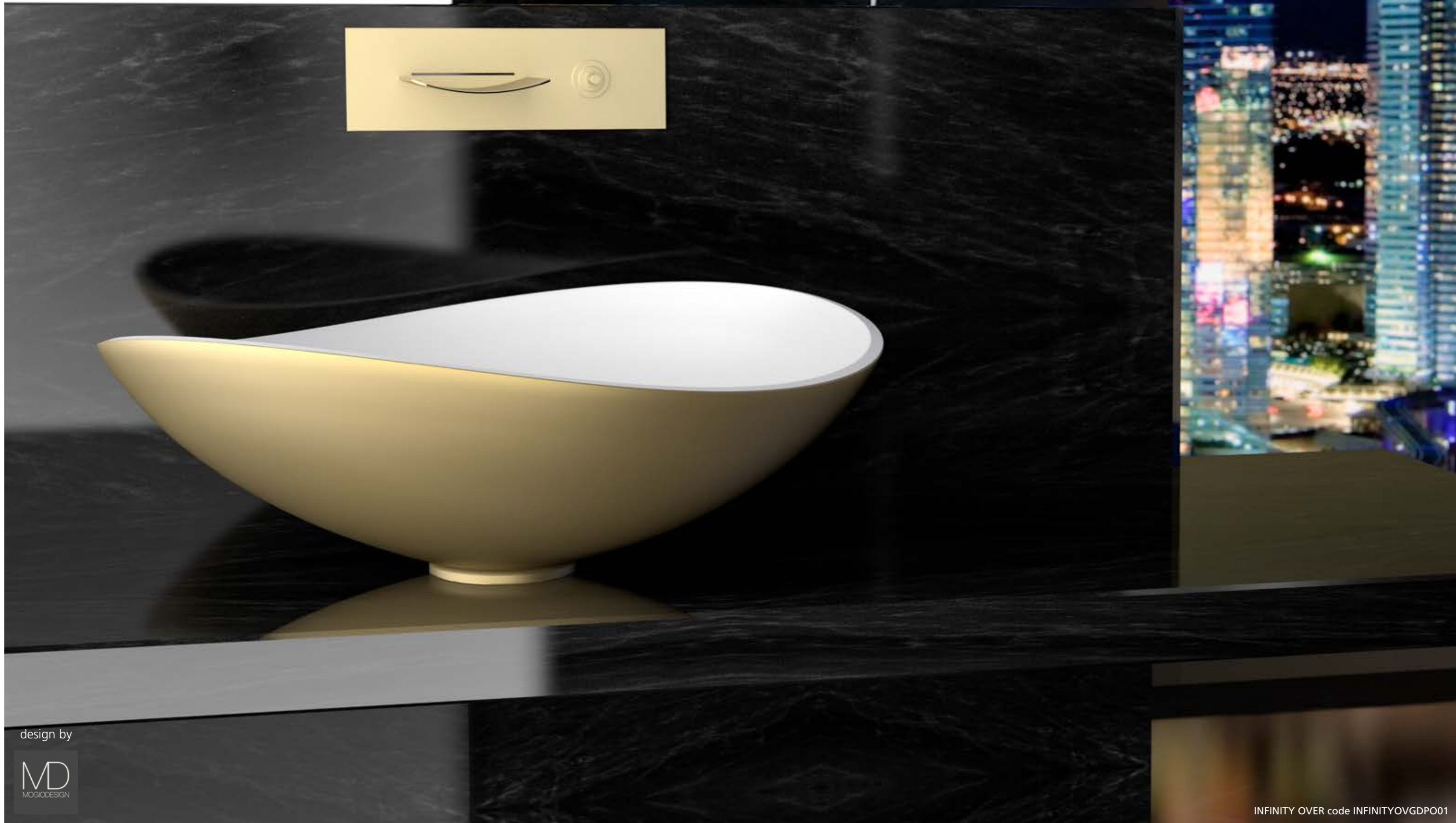

design by

MD
MOGIODESIGN

INFINITY OVER code INFINITYOVGDPO01



brevettato / patented

Collina

VetroFreddo®



COLLINA code COLLINAP030



brevettato / patented

design by **Studio ARIUS**

94

95

ALA 100

Vetro Freddo®



ALA 100 code ALA100GDPO01



Play

Vetro Freddo®



PLAY code PLAYPO1

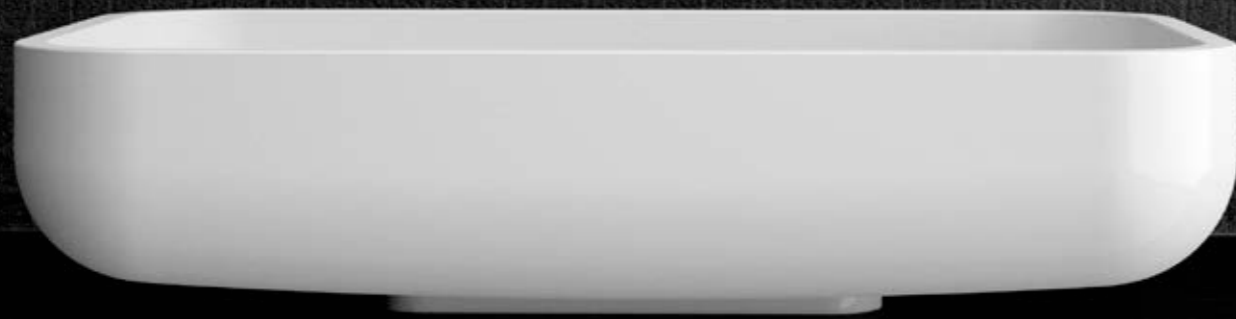

PLAY code PLAYPL1



PLAY code PLAYPO30



Net

Vetro Freddo®



NET code NETPO30
Accessori da bagno- Bath accessories NAVY



NET code NETPO01



NET code NETTO34



Stone

VetroFreddo®



STONE code STONEPO01



STONE code STONETO35
Accessori da bagno - Bath accessories KLEISS



STONE code STONEPO30

STONE code STONEPO33



TeknoForm®

L'esaltazione delle superfici da molteplici materiali.
Enhancement of material surfaces.

TeknoForm® è il materiale delle "texture", costituito da polimeri di varia natura, si esprime dando vita a prodotti monoscocca, esaltando le sue superfici. Dai mosaici alle pietre, dai marmi ai legni, tante soluzioni che danno vita a prodotti unici.

TeknoForm® is a polymer-based material. It expresses itself by enhancing the surface of its products. From mosaics to stone, from marble to wood, an incredible variety of solutions can be realized in creating unique products.

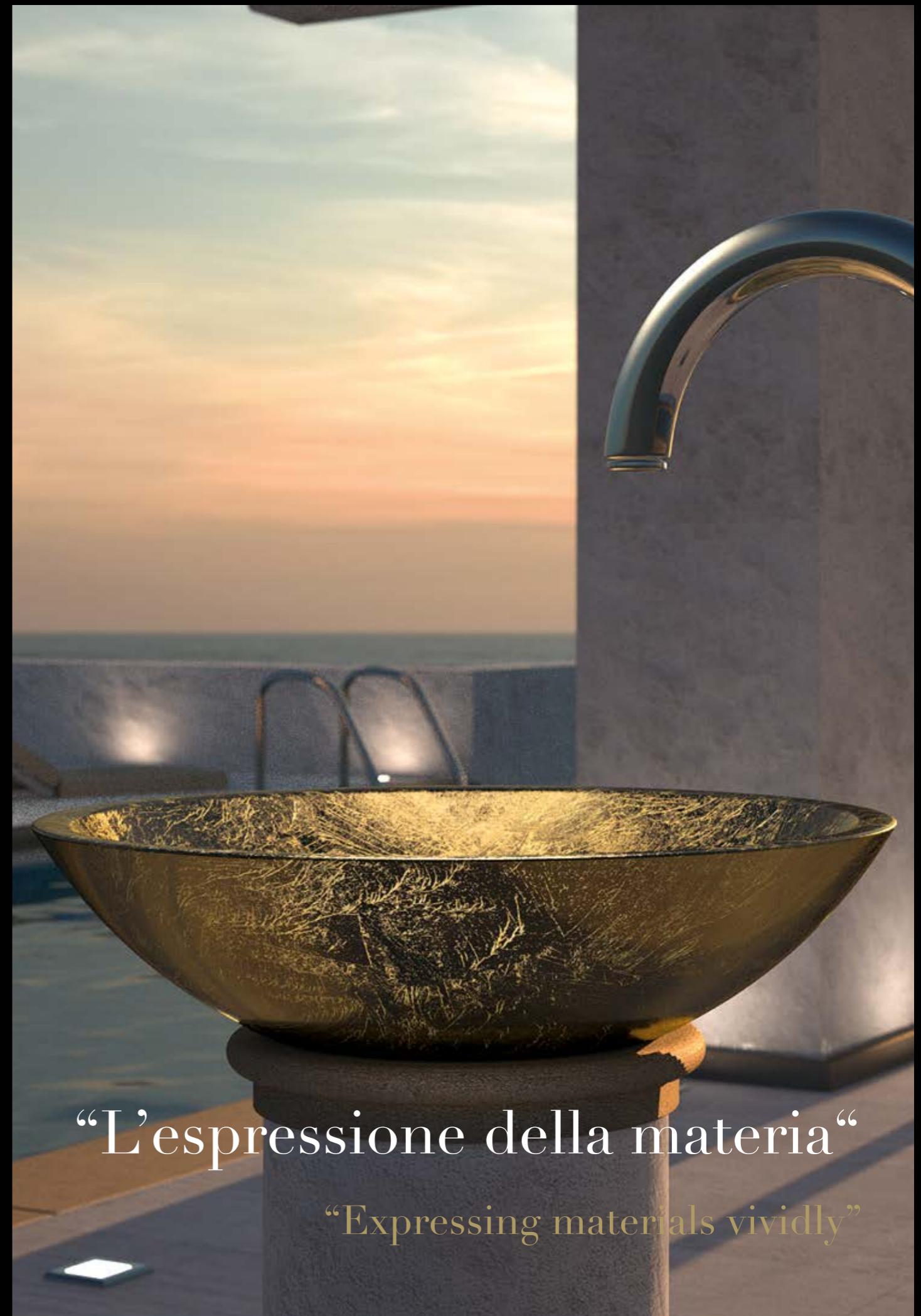

“L'espressione della materia”

“Expressing materials vividly”



Cocoon Metal

TeknoForm®



COCOON METAL code COCOONPLP001



COCOON METAL code COCOONDIP001



Cocoon Lux

TeknoForm®



COCOON LUX code COCOONFOPO01



Cocoon Materic

TeknoForm®



COCOON MATERIC code COCOONBL



Mosaic

TeknoForm®

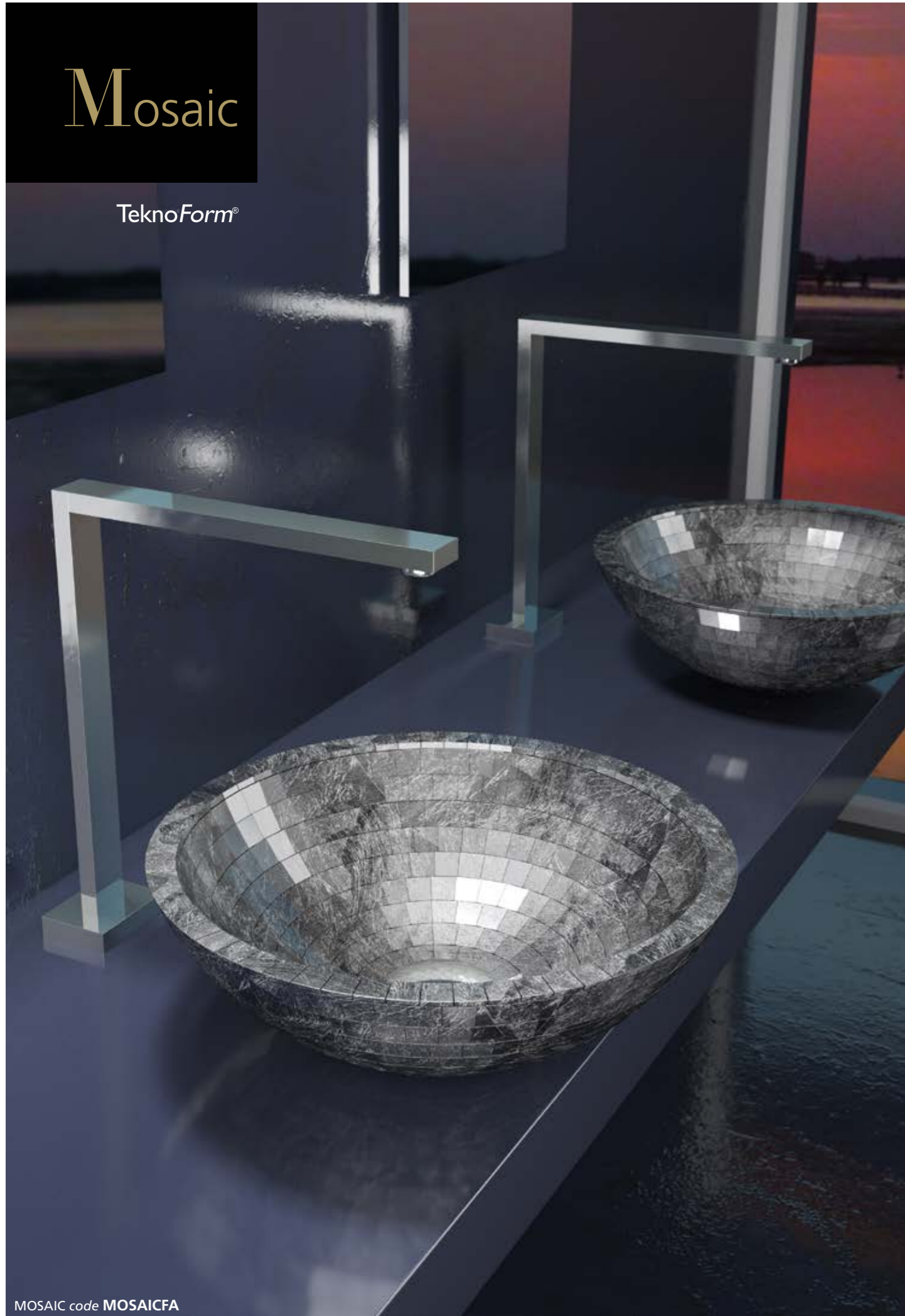

MOSAIC code MOSAICFA



brevettato / patented

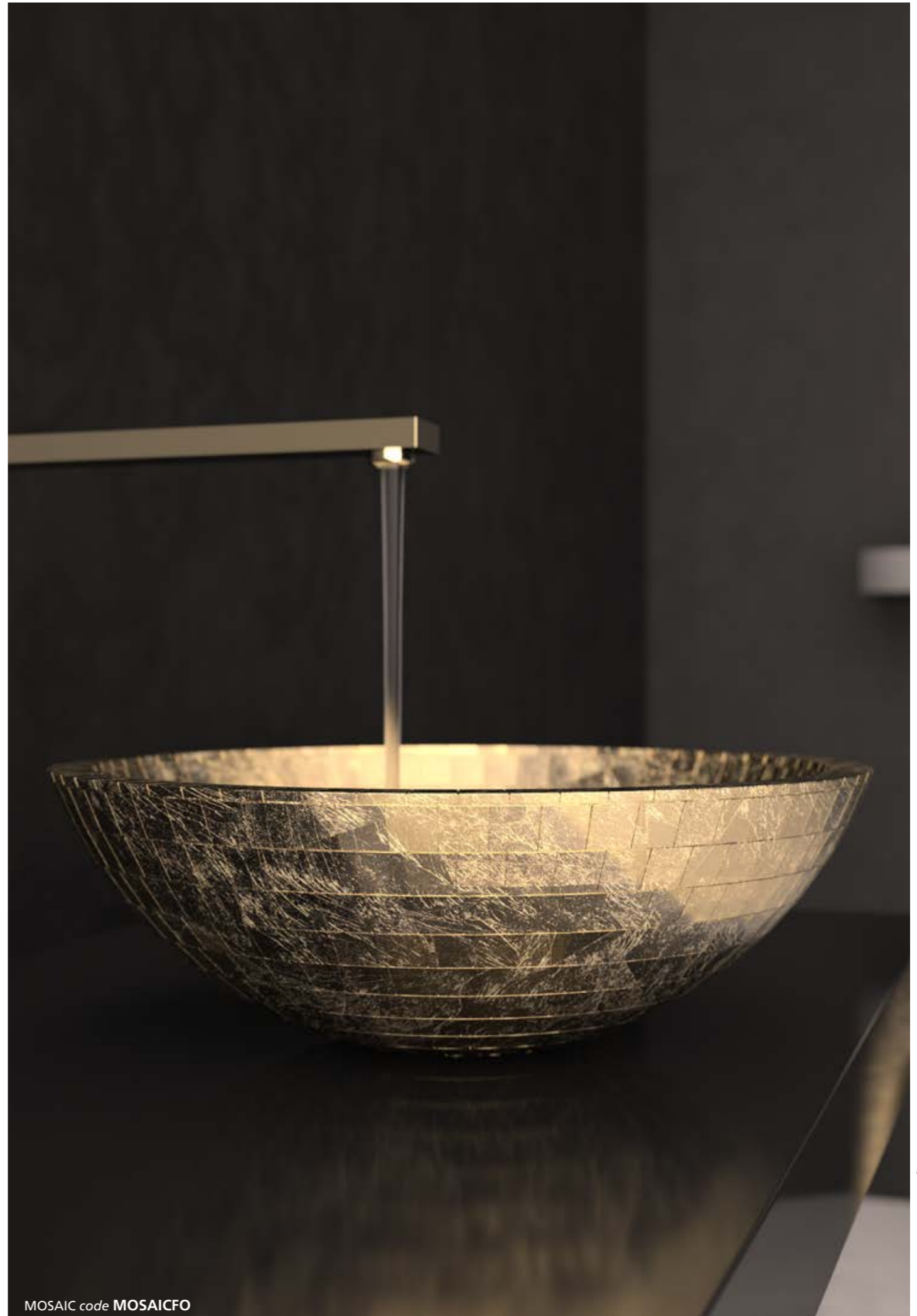

MOSAIC code MOSAICFO



brevettato / patented

design by **Studio ARIUS**

Circus 50

TeknoForm®

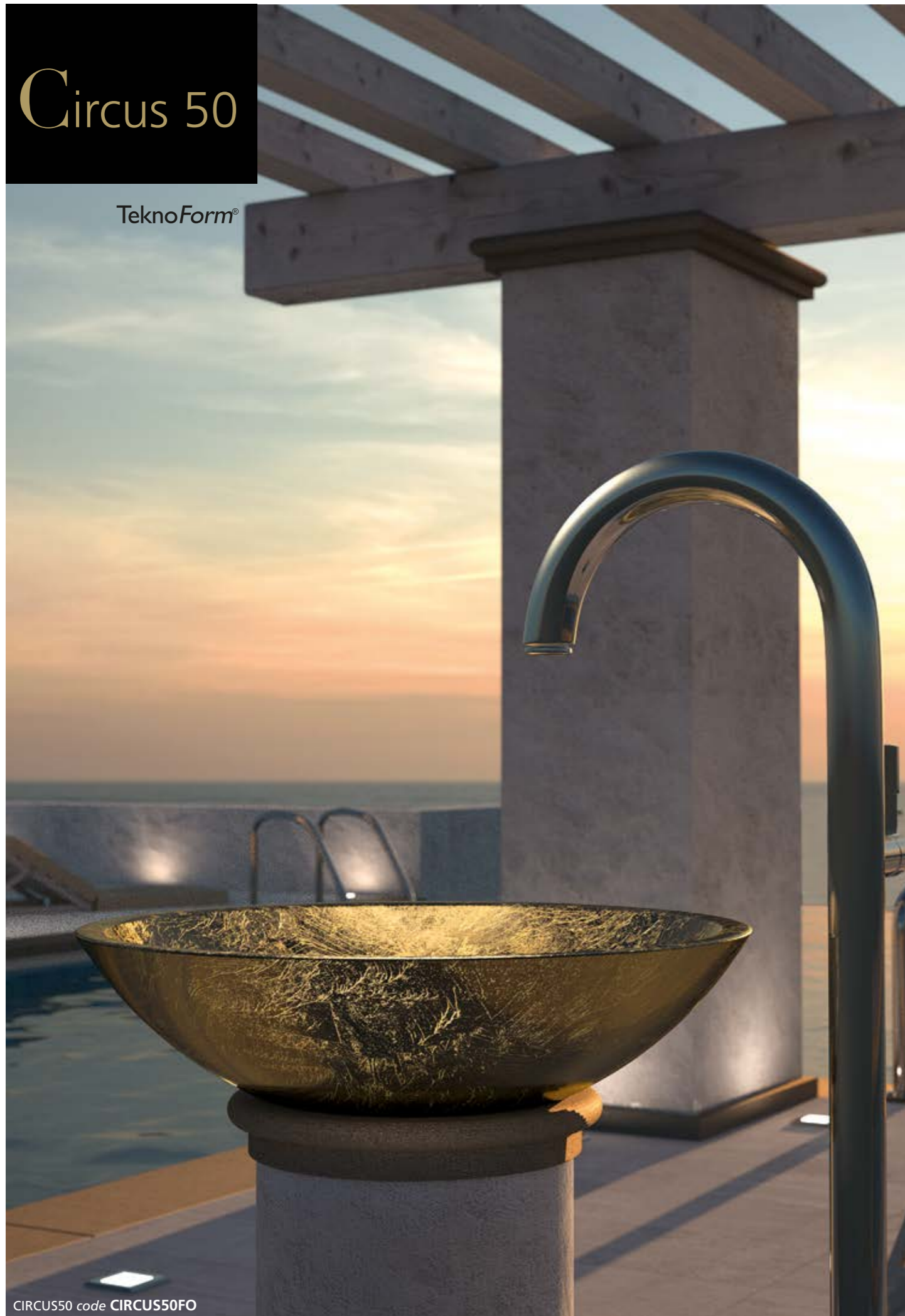

CIRCUS50 code CIRCUS50FO



CIRCUS50 code CIRCUS50FA



Circus 43

TeknoForm®



CIRCUS43 code CIRCUS43FO

114



CIRCUS43 code CIRCUS43FA



CIRCUS43 code CIRCUS43PO30

115



CIRCUS43 code CIRCUS43PO01



Circus 43
Travertino
TeknoForm®



CIRCUS 43 TRAVERTINO code CIRCUS43ST31



Oval
Travertino
TeknoForm®



OVAL TRAVERTINO code OVALST01



Rapolano

TeknoForm®



RAPOLANO 45 code RAP45B - RAP45ST30 - RAP45ST - RAP45TC



brevettato / patented

design by **Studio ARIUS**

118

119

Roma

TeknoForm®

design by: **Cairolì - Donzelli**



ROMA code **ROMAFA**



brevettato / patented

Pert[®]
polimero tecnologico

Leggerezza e design sposano la tecnologia.
Light weight, spectacular design, innovative technology.

Il Pert[®] è un polimero tecnologico dalle qualità eccezionali, che unisce un basso peso specifico ad un'elevata resistenza meccanica. Particolarmente adatto in quei settori dove l'esigenza della leggerezza del peso è fondamentale (nautico, aereo, camper...). E' un materiale che permette la realizzazione di prodotti di elevato design, eseguiti a regola d'arte, rispettando angoli, raggi, bassorilievi e planarità con la possibilità di scelta tra una vasta gamma di colori, personalizzabili a richiesta.

Pert[®] is a technological polymer of extraordinary quality, combining a low specific weight with high mechanical resistance. It is particularly suited to fields where light weight is essential (e.g. in nautical, aeronautical, camping, etc).

It is a material which enables the creation of products of high design, finely made, allowing perfectly crafted angles and a smoothly plane surface, with the possibility of choosing among a wide range of colours to suit individual demand.



“Collezione d’arte futurista”

“The avant-garde collection”



FLower

Pert®

design by: **Marco Pisati**



FLOWER code FLOPL34



brevettato / patented

124

125

FLOWer

Pert®

design by: **Marco Pisati**



FLOWer code **FLO402**



brevettato / patented



FLOWer code **FLOBL**



brevettato / patented

Rho
Metal

Pert



RHO METAL code RHOGD



RHO METAL code RHOPL



Rho
Lux
Pert®



RHO LUX code RHOFO



RHO LUX code RHOF A



Rho Vision

Pert®



RHO VISION code **RHONO**



RHO VISION OLD COPPER code **RHOCPO**



RHO VISION OLD BRONZE code **RHOBZO**



Rho Starlight

Pert®



RHO STARLIGHT code RHOLH05

Four Starlight

Pert®



FOUR STARLIGHT code FOURLH05



RHO STARLIGHT code RHOLH01

design by **Studio ARIUS**



design by **Studio ARIUS**

Four Lux

Pert®



FOUR LUX code FOURFO

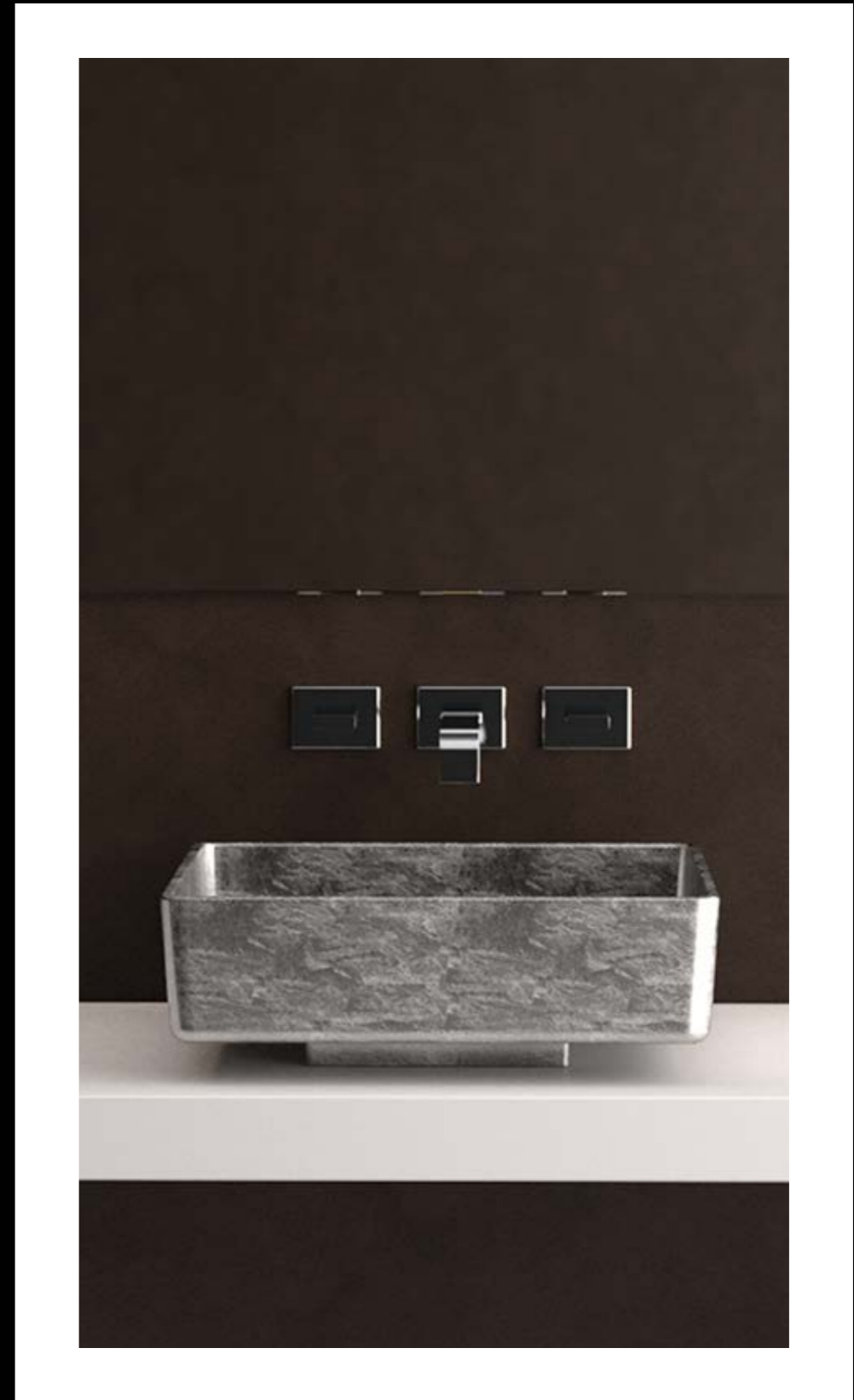

FOUR LUX code FOURFA



Four
Vision

Pert®



FOUR VISION code FOURBO

design by **Studio ARIUS**



Blade Vision

Pert®

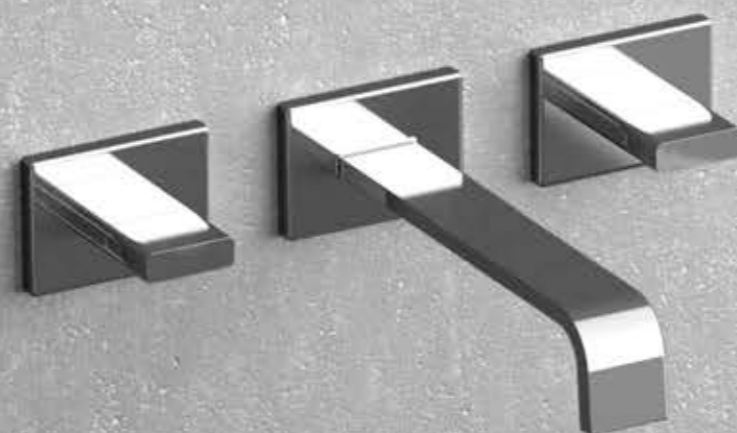

BLADE VISION code **BLADENO**

design by **Studio ARIUS**



Infinity Colour

Pert



design by

MD
MOGIDDESIGN

INFINITY COLOUR code **INFINITYPL34**



brevettato / patented

Infinity Starlight

Pert®



design by



INFINITY STARLIGHT code **INFINITYLH30**



brevettato / patented



INFINITY STARLIGHT code **INFINITYLH01**



brevettato / patented

Open

Pert®

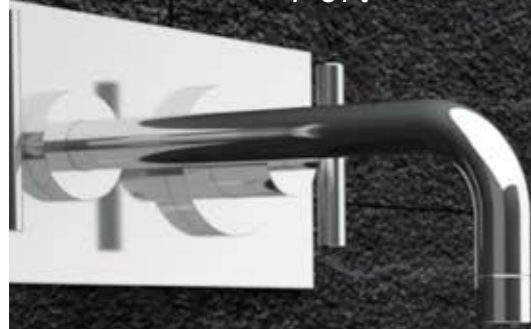

OPEN code OPENFA



OPEN code OPENFO



OPEN code OPENBL - OPEN406 - OPEN402



Alumix[®]
lega d'alluminio

L'hi-tech, elegante e contemporaneo.
Distinguishing with contemporary elegance.

Prodotto hi-tech, elegante e contemporaneo che nasce da una fusione di lega di alluminio. La decorazione è realizzata a pennello, con la tecnica del graffiato, per ottenere un effetto bicromatico. Il bordo è spazzolato e lucidato a mano, per valorizzare l'anima ed il colore tipico di questo materiale.

A high-tech product, both elegant and contemporary, born from a merger of aluminum alloys. The decorations are brush-painted, employing a special brush technique in order to obtain a bi-chromatic effect. The board is brushed and polished by hand to enhance the soul and color, which are typical for this material.



“L'espressione dell'Art-Tech”

“The expression of Art-Tech”



Exté Lux

Alumix®



EXTE' LUX code **ALUEXTELWG**

bordo finitura alluminio / edge aluminium colour



brevettato / patented



EXTE' LUX code **ALUEXTELWS**

bordo finitura alluminio / edge aluminium colour



EXTE' LUX code **ALUEXTELBG**

bordo finitura alluminio / edge aluminium colour



brevettato / patented

design by **Studio ARIUS**

Exté

Alumix®



EXTE' code **ALUEXTETA02**

bordo finitura alluminio / edge aluminium colour



brevettato / patented



EXTE' code **ALUEXTETA05**

bordo finitura alluminio / edge aluminium colour



brevettato / patented

design by **Studio ARIUS**

Nek
Lux

Alumix[®]



NEK LUX code **ALUNEKLBS**

bordo finitura alluminio / edge aluminium colour



NEK LUX code **ALUNEKLBG**

bordo finitura alluminio / edge aluminium colour



NEK LUX code **ALUNEKLWG**

bordo finitura alluminio / edge aluminium colour



Nek

Alumix®

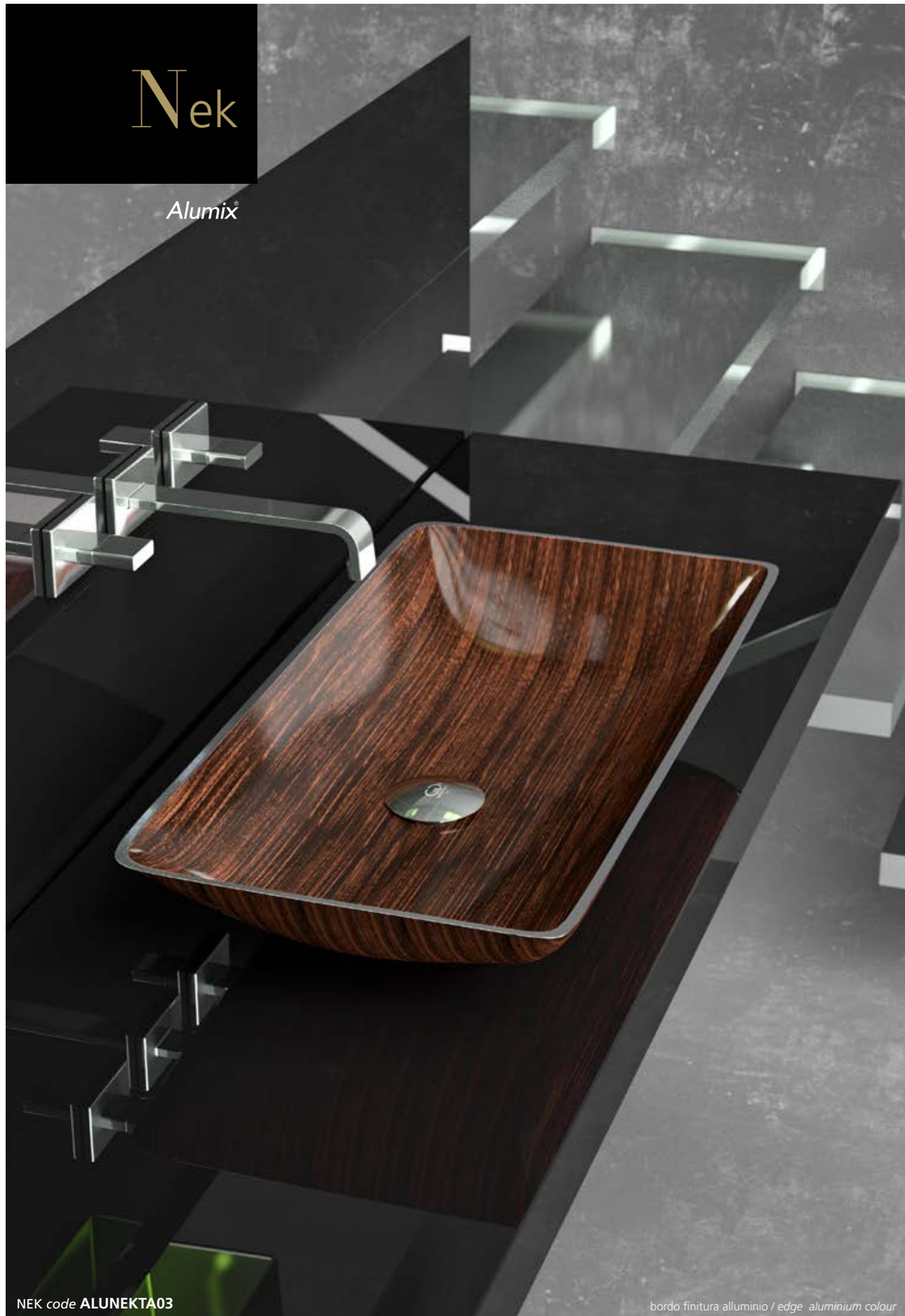

NEK code ALUNEKTA03

bordo finitura alluminio / edge aluminium colour



NEK code ALUNEKTA05

bordo finitura alluminio / edge aluminium colour



NEK code ALUNEKTA02

bordo finitura alluminio / edge aluminium colour



Ares

Alumix®

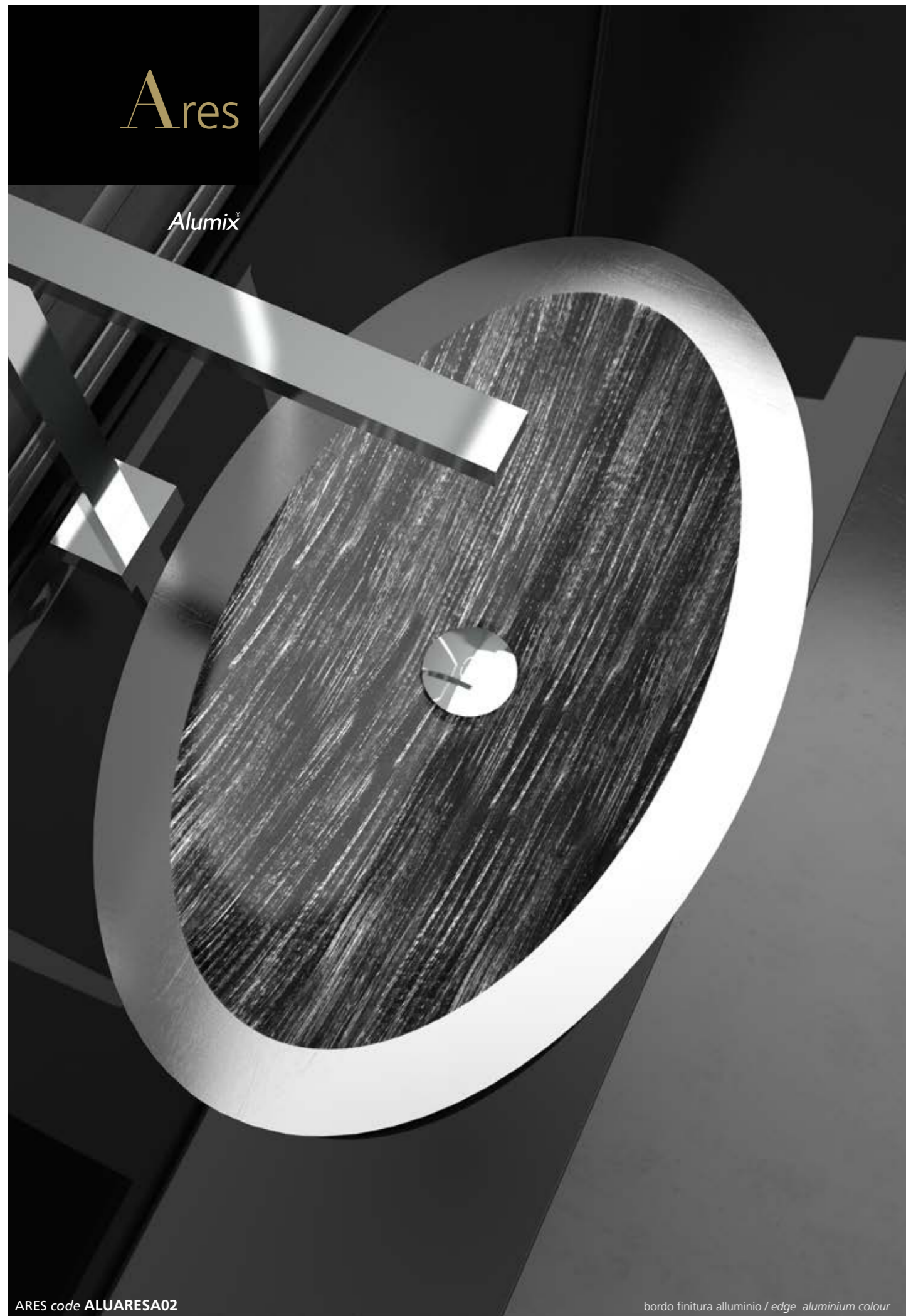

ARES code **ALUARESA02**

bordo finitura alluminio / edge aluminium colour



158

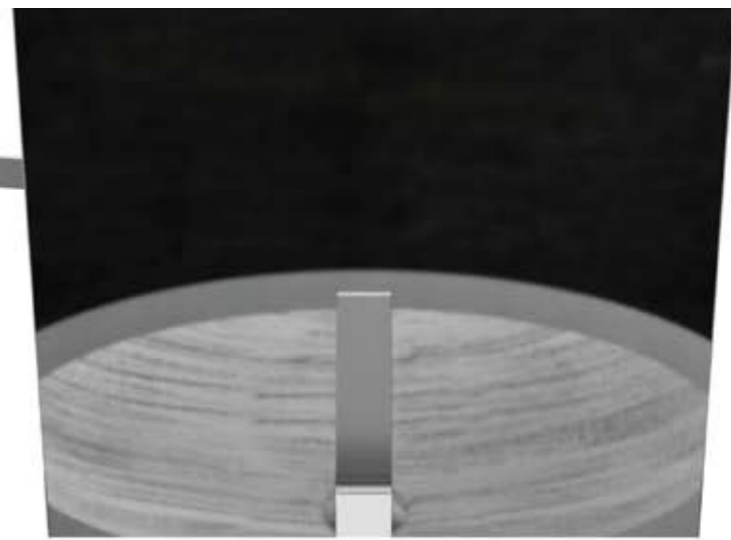

ARES code **ALUARESA07**

bordo finitura alluminio / edge aluminium colour



159

design by **Studio ARIUS**

Round

Alumix®



ROUND code **ALUROA05**
Accessori da bagno - Bath accessories **GLAMOUR**

bordo finitura alluminio / edge aluminium colour



brevettato / patented



bordo finitura alluminio / edge aluminium colour

ROUND code **ALUROA04**
Accessori da bagno - Bath accessories **GLAMOUR**



bordo finitura alluminio / edge aluminium colour

ROUND code **ALUROA02**
Accessori da bagno - Bath accessories **GLAMOUR**



brevettato / patented

design by **Studio ARIUS**

Vogue

Alumix®



VOGUE code ALUVOA02

bordo finitura alluminio / edge aluminium colour



brevettato / patented

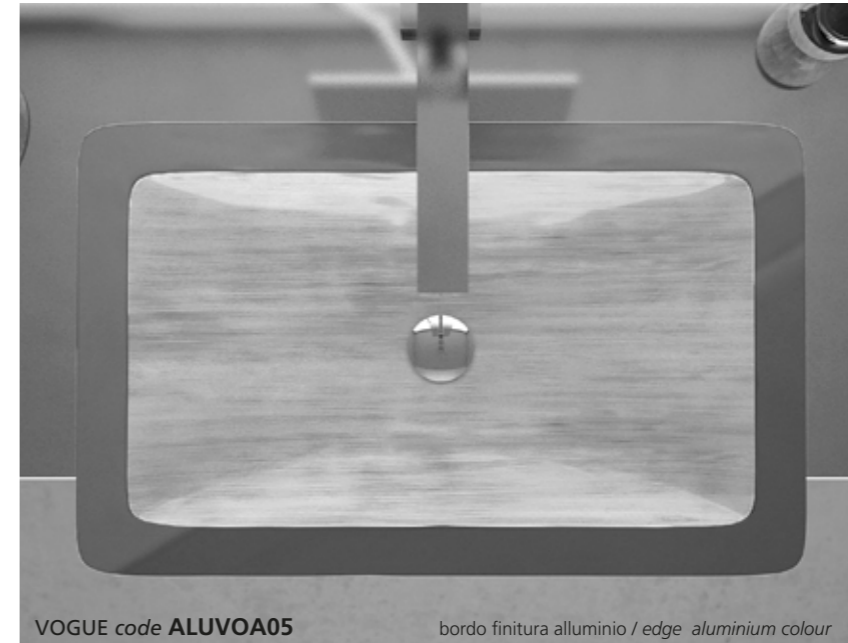

VOGUE code ALUVOA05

bordo finitura alluminio / edge aluminium colour



VOGUE code ALUVOA03

bordo finitura alluminio / edge aluminium colour



brevettato / patented

design by Studio ARIUS

Norite

Alumix®



Reverse

Alumix®



166

167

REVERSE code REVERSECP



design by **Studio ARIUS**

Oxidren

Alumix[®]

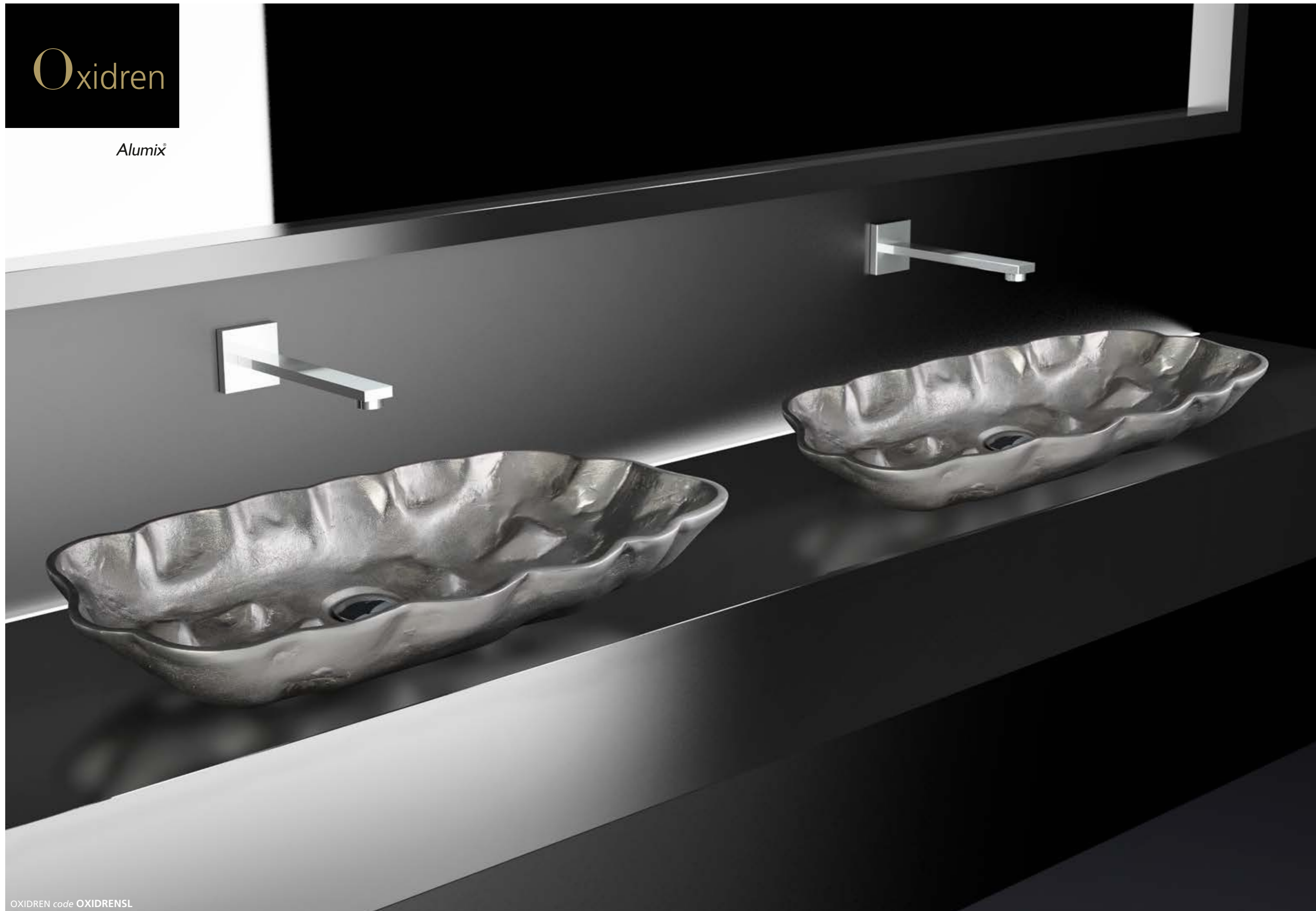

168

169

OXIDREN code OXIDRENSL



design by **Studio ARIUS**

Florence Glass
ATELIER[®]

L'ultima tendenza di oggetti decorati a mano.
Avant-garde trends in artisan product design.

Il progetto Atelier nasce dalla ricerca stilistica che una nostra equipe interna realizza rivolgendo lo sguardo al mondo della moda. I colori e le texture che vengono rappresentati nel programma sono la sintesi delle nuove tendenze.

The "Florence Glass Atelier" project is inspired by embedding the philosophy of the fashion world into product research. The focus lays on enhancing crystal material with colours and textures of fashion trends.

“Collezioni esclusive
dal mondo della moda”
*“Exclusive collection
inspired by the fashion world”*

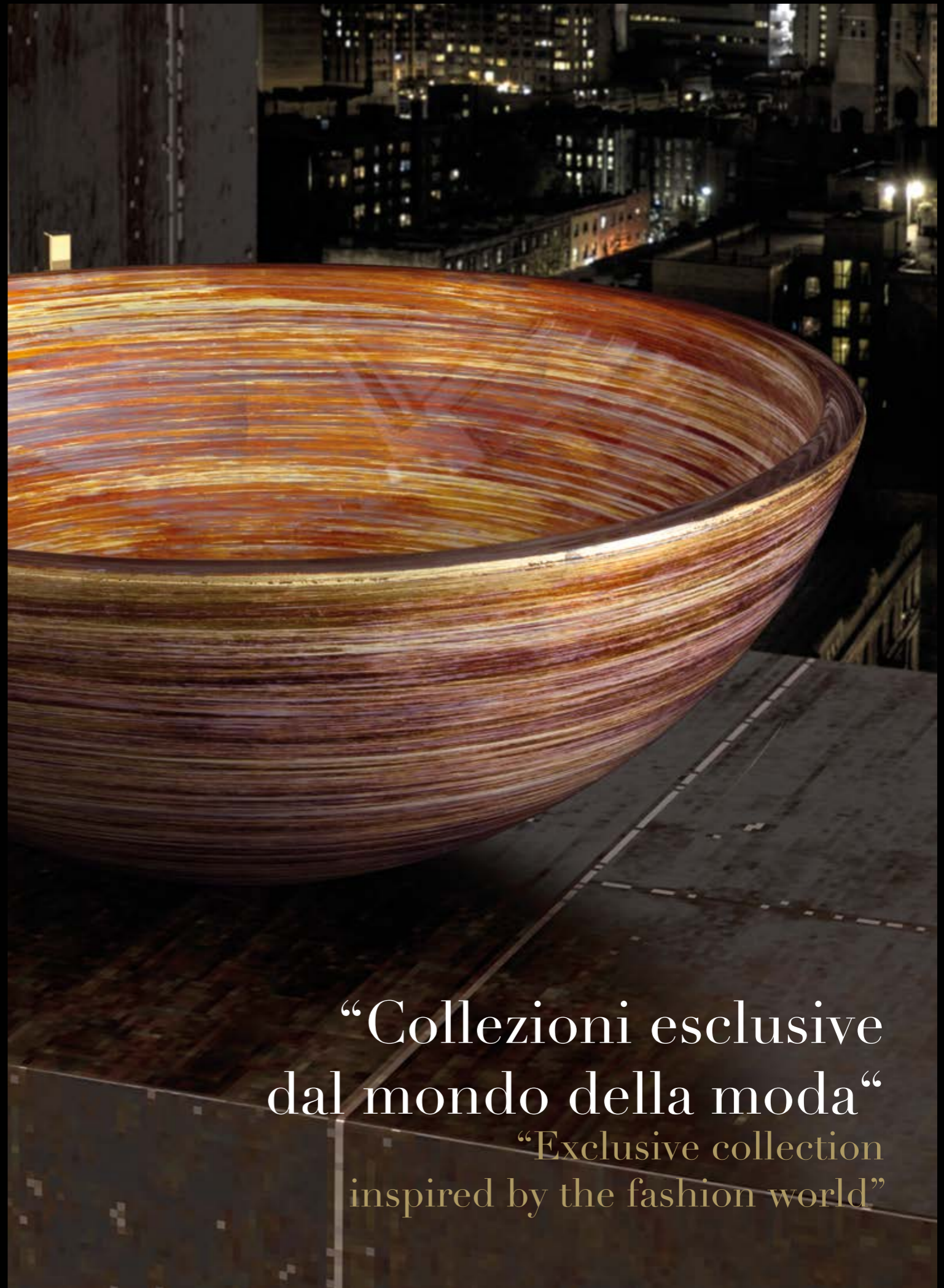

Metropole Katino

Florence Glass
ATELIER



METROPOLE Katino code **KATINOMAT**



brevettato / patented



METROPOLE Katino code **KATINOMPL**



METROPOLE Katino code **KATINOMBZ**



brevettato / patented

Metropole

Flou

Florence Glass
ATELIER

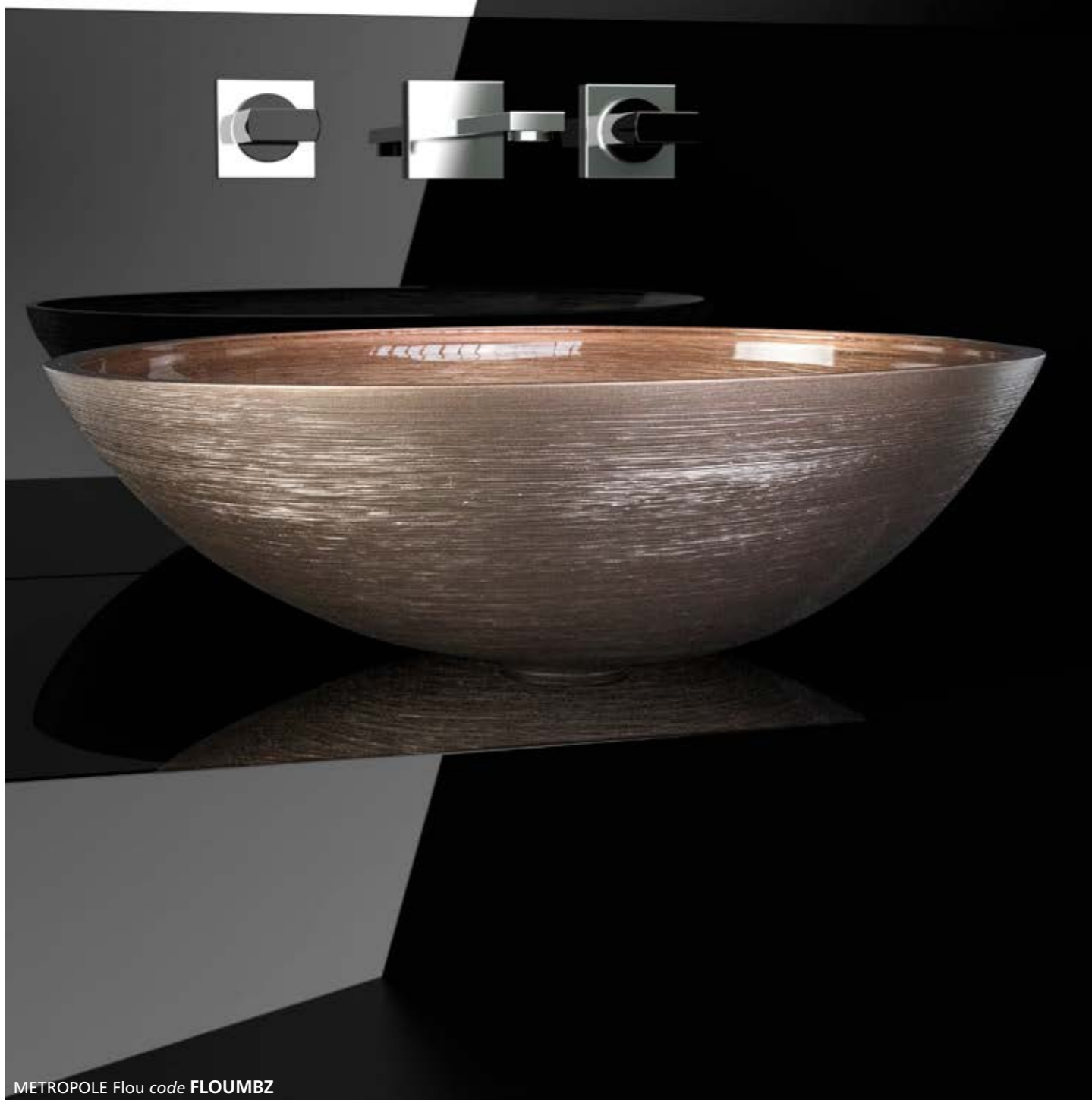

METROPOLE Flou code FLOUMBZ



brevettato / patented

design by **Studio ARIUS**

Metropole

Round

Florence Glass
ATELIER



METROPOLE Round code METROPOLE44PL



brevettato / patented

design by **Studio ARIUS**

174

175

Tekno Materic

Florence Glass
ATELIER®



TEKNO MATERIC code TEKNO40BO



brevettato / patented

design by **Studio ARIUS**

177

176

Tekno Metal

Florence Glass
ATELIER®

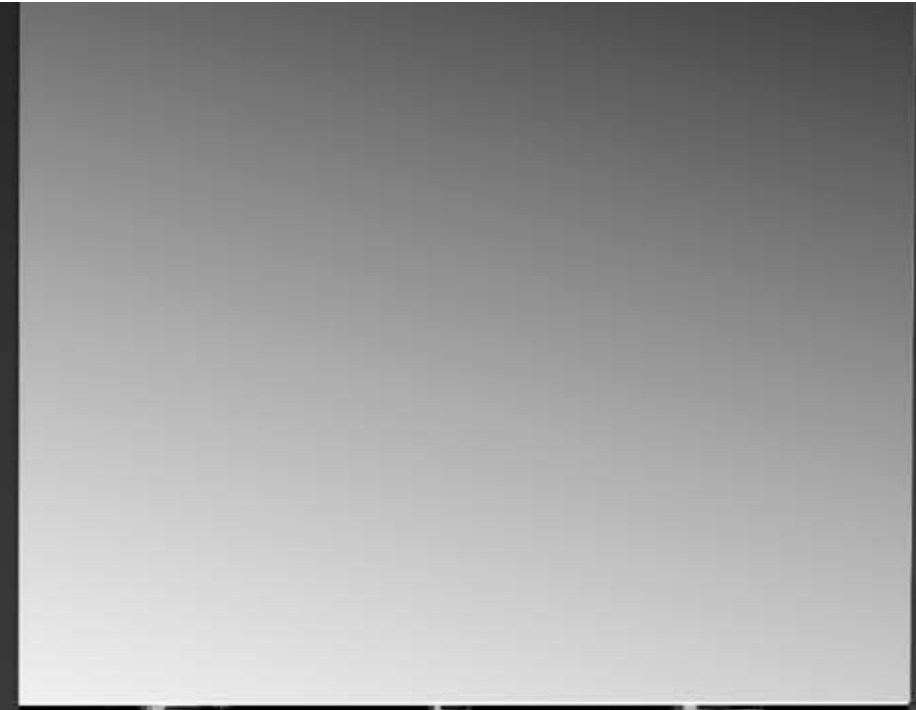

TEKNO METAL code TEKNO40BZ



brevettato / patented

design by **Studio ARIUS**

179

178

Tekno Lux

Florence Glass
ATELIER®



180

181



TEKNO LUX code **TEKNOL40GD**

brevettato / patented

design by **Studio ARIUS**

Graffiti

Florence Glass
ATELIER®

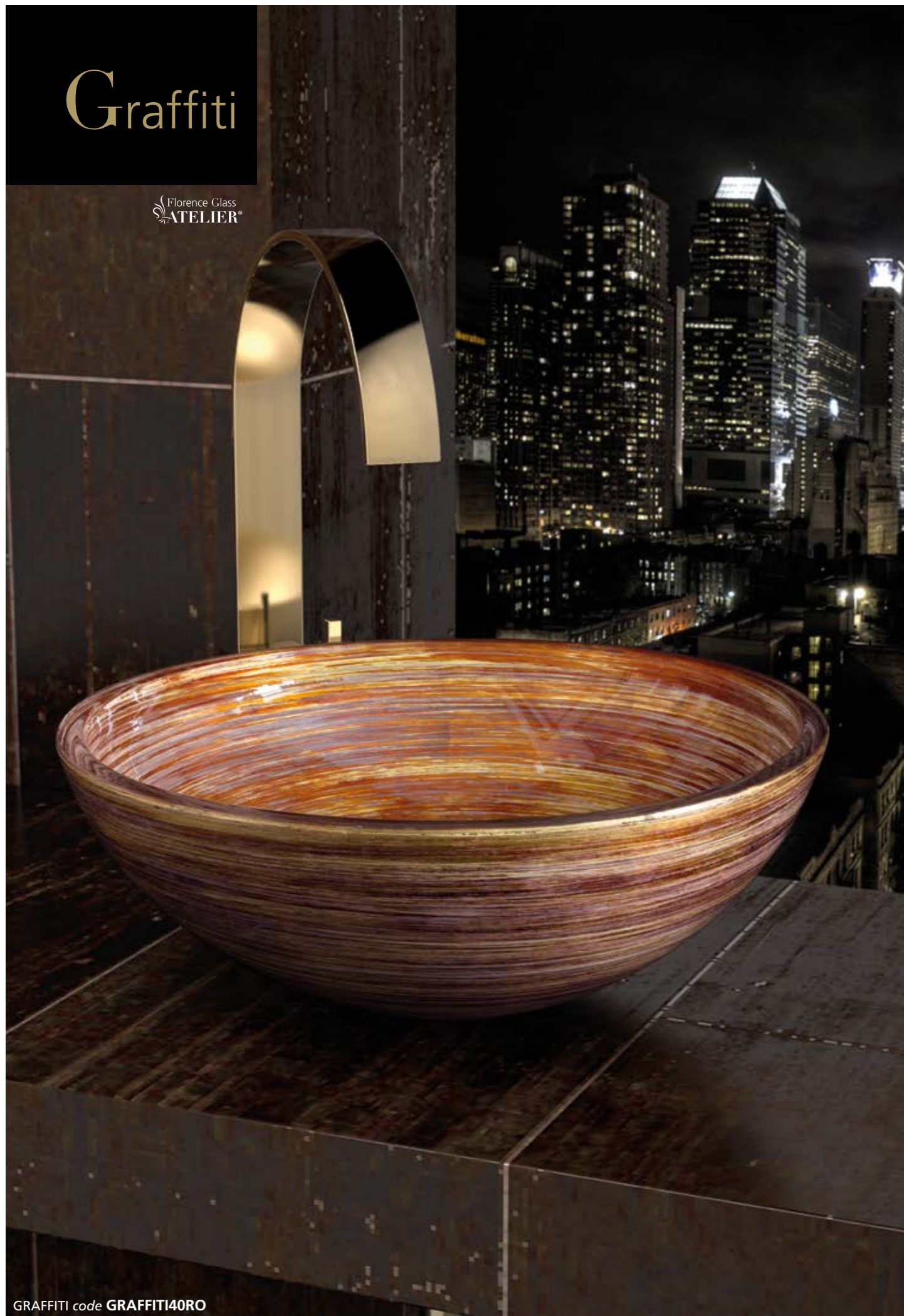

GRAFFITI code GRAFFITI40RO



GRAFFITI code GRAFFITI40BG



design by **Studio ARIUS**

Venice

Florence Glass
ATELIER®



VENICE code VENICE44OA



VENICE code VENICE40AN



VENICE code VENICE44MA



Mosaic

Anniversary

Florence Glass
ATELIER®



MOSAIC Anniversary code **MOSAICTPL**
Manopole per rubinetto in cristallo trasparente/platino - clear/platinum crystal faucet handles - **GLAMOROUS TUNING** collection



brevettato / patented

design by **Studio ARIUS**

186

187

Mosaic

Anniversary Sotto

Florence Glass
ATELIER

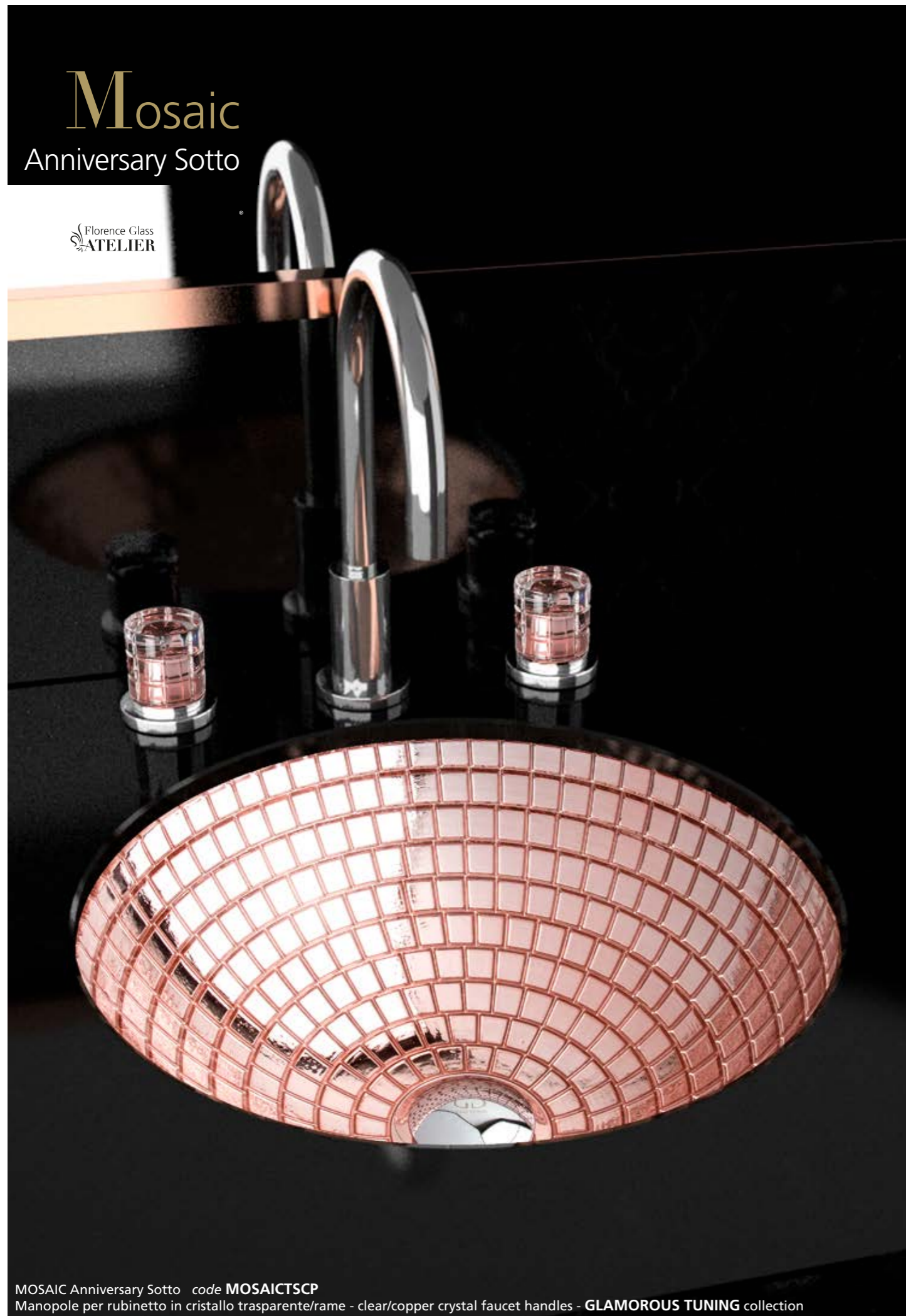

MOSAIC Anniversary Sotto code **MOSAICTSCP**
Manopole per rubinetto in cristallo trasparente/rame - clear/copper crystal faucet handles - **GLAMOROUS TUNING** collection



brevettato / patented

188



MOSAIC Anniversary Sotto code **MOSAICTSSL**
Manopole per rubinetto in cristallo trasparente/argento - clear/silver crystal faucet handles - **GLAMOROUS TUNING** collection



brevettato / patented

189

design by **Studio ARIUS**

Luna

Florence Glass
ATELIER®



LUNA code LUNA44YL

“Tecnologia esclusiva”
“Exclusive technology”



brevettato / patented

La pietra come fonte di ispirazione. Il risultato è una speciale combinazione del cemento applicato sul cristallo.

Natural stone, a source of inspiration, reflected in a uniquely decorative application of concrete to crystal.



LUNA code LUNA44GR



brevettato / patented

design by Studio ARIUS

Luna Katino

Florence Glass
ATELIER®



LUNA KATINO code KATINOLGR



brevettato / patented



LUNA KATINO code KATINOLSN



brevettato / patented

design by **Studio ARIUS**

192

193

Gala

Florence Glass
ATELIER®



GALA code GALA44FO

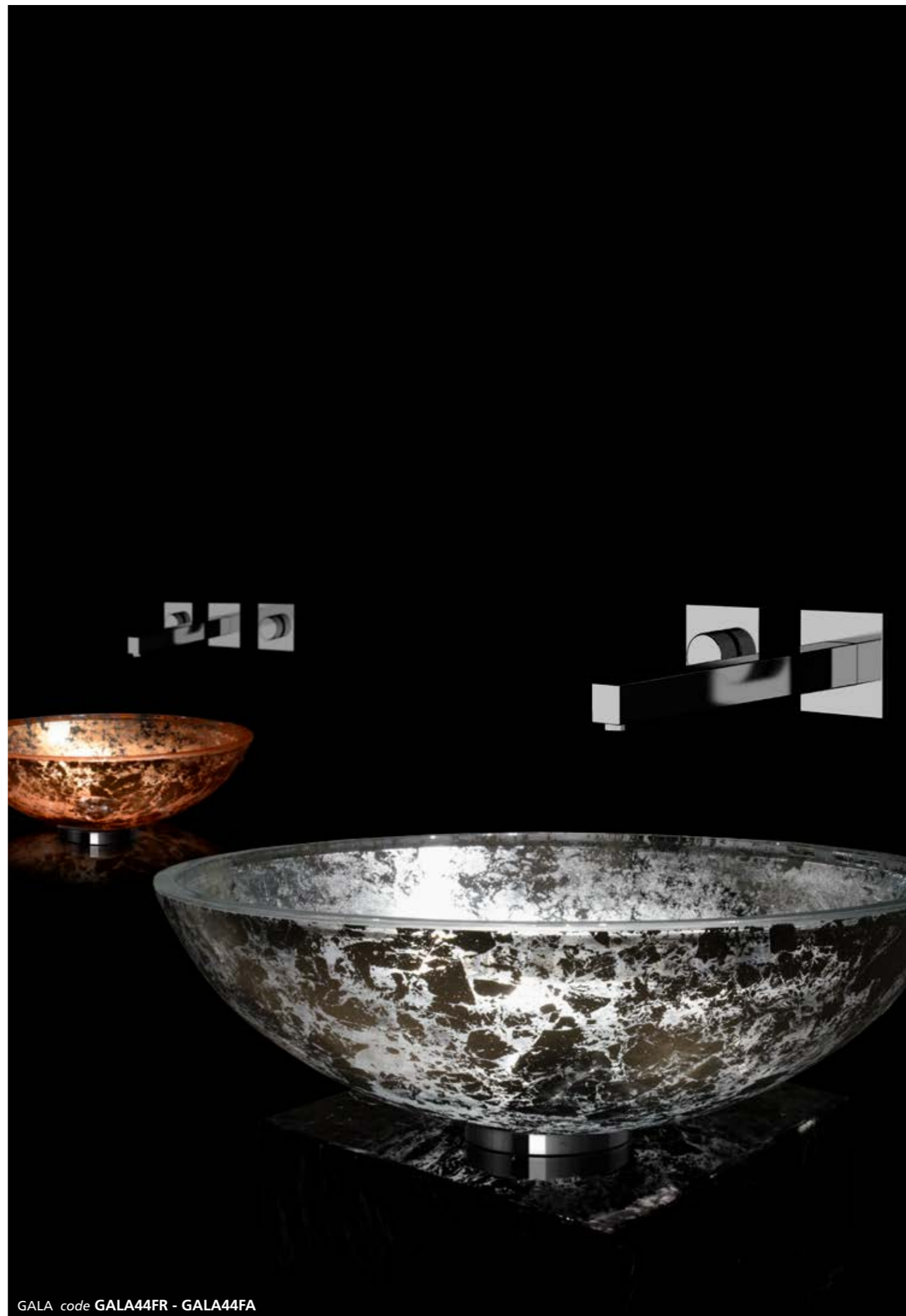

GALA code GALA44FR - GALA44FA



Kalahari

Florence Glass
ATELIER



KALAHARI code KALAHARI40WG



KALAHARI code KALAHARI40BS



design by **Studio ARIUS**

Xeni

Florence Glass
ATELIER



XENI code XENIT01WHITE



brevettato / patented



XENI code XENIT30BLACK



brevettato / patented

design by Studio ARIUS

198

199

Flare

Florence Glass
ATELIER



FLARE code FLARE40S01

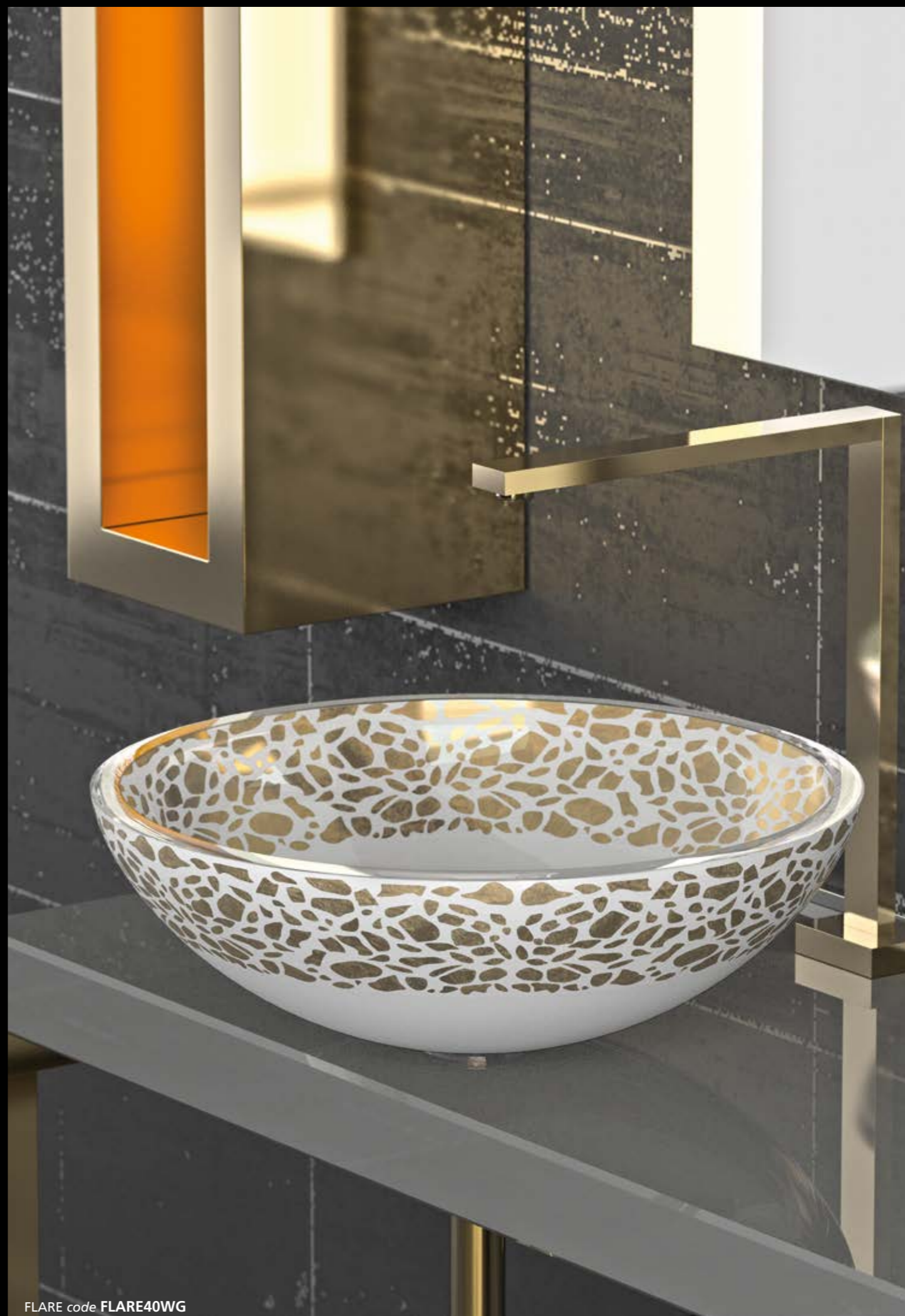

FLARE code FLARE40WG



Filigrana

Florence Glass
ATELIER®



FILIGRANA code **FILIGRANA40WG**



FILIGRANA 40 code **FILIGRANA40FAB**

design by **Studio ARIUS**



brevettato / patented

Flare Tech

Florence Glass
ATELIER®



FLARE TECH code **FLARET40WG**



FLARE TECH 40 code **FLARET40BS**
overflow joint code **TP**

design by **Studio ARIUS**



brevettato / patented

Drop Katino

Florence Glass
ATELIER®

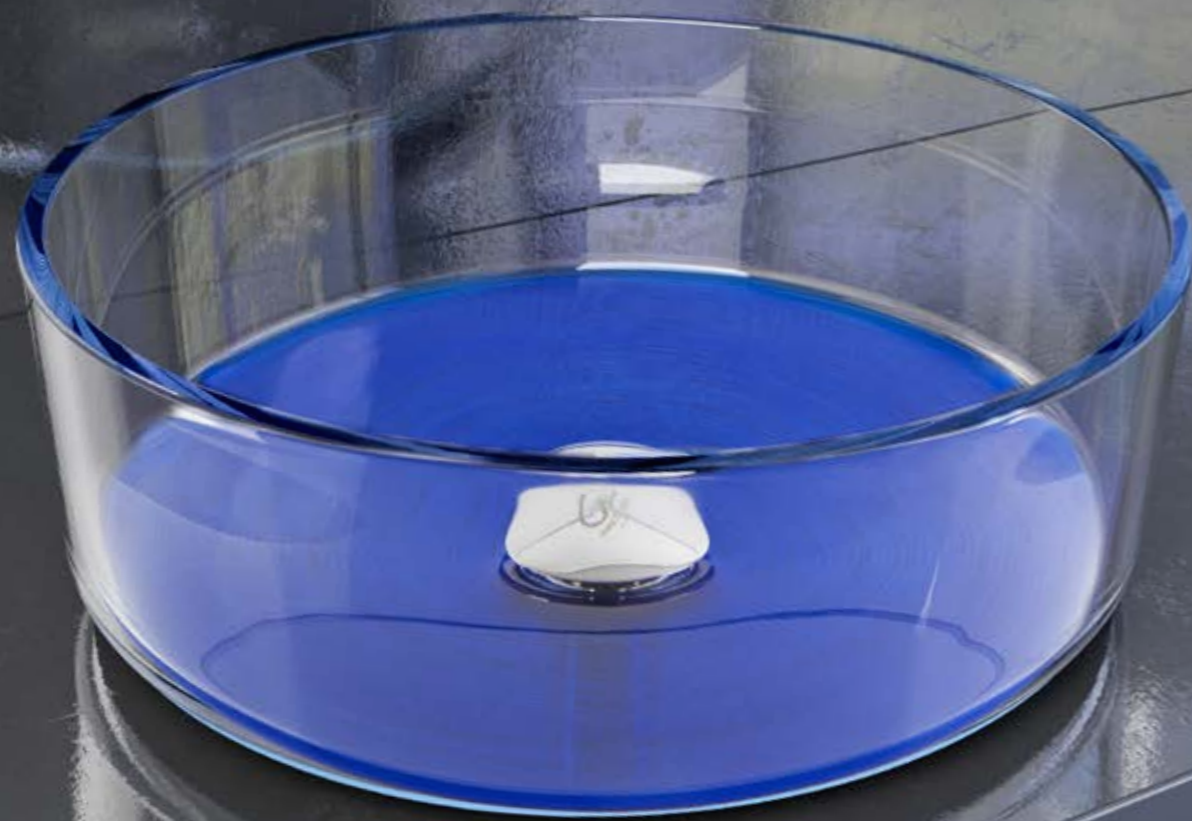

DROP KATINO code **DROPK39T18**



brevettato / patented



DROP KATINO code **DROPK39T12**



brevettato / patented

design by **Studio ARIUS**

Drop Katino

Florence Glass
ATELIER®



DROP KATINO code **DROPK39T20**
Manopole rubinetto cristallo trasparente/marine Crystal faucet handles clear/marine **GLAMOROUS TUNING** Collection



brevettato / patented

design by **Studio ARIUS**

FloU

Florence Glass
ATELIER



Vetro artistico interamente lavorato a mano.
Eventuali piccole imperfezioni sono la caratteristica di un prodotto artigianale.

Artistic glass hand-made.
Some tiny bubbles may appear in the basin, highlighting the character of objects individually made by hand by our master glassmakers.

FLOU code **FLOUT01**



Soffio

Florence Glass
ATELIER

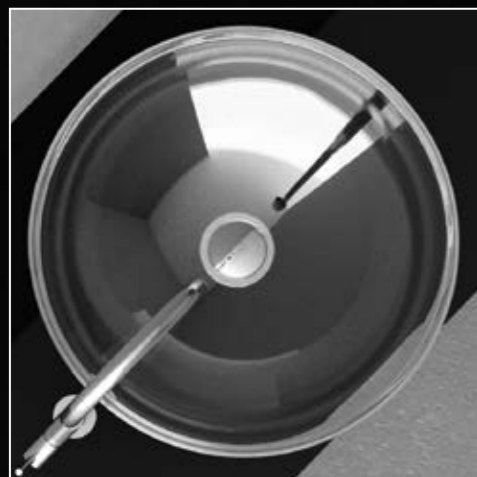

SOFFIO code SOFFIOT01

Vetro artistico interamente lavorato a mano.
Eventuali piccole imperfezioni sono la caratteristica di un prodotto artigianale.

Artistic glass hand-made.
Some tiny bubbles may appear in the basin, highlighting the character of objects
individually made by hand by our master glassmakers.

design by **Studio ARIUS**



Globo

Florence Glass
ATELIER



GLOBO code GLOBO34BO - GLOBO34NO

design by **Studio ARIUS**



brevettato / patented

Bamboo

Katino

Florence Glass
ATELIER®



BAMBOO KATINO code BAMBOOK39GR



Mistral Lux

Florence Glass
ATELIER



MISTRAL LUX code MISTRALLPGF4



MISTRAL LUX code MISTRALLPLF4



MISTRAL LUX code MISTRALLGDF4



City
Lux

Florence Glass
ATELIER



CITY LUX code CITY40LPLF4



CITY LUX code CITY40LSLF4



CITY LUX code CITY40LPGF4



Arabesque Lux

Florence Glass
ATELIER



ARABESQUE LUX code ARABESQUELGDF3



ARABESQUE LUX code ARABESQUELSLF4



ARABESQUE LUX code ARABESQUELPGF4



INOX ZERO®

L'evoluzione dell'inox.
Inox evolution.

Nuova tecnologia applicata per dar vita ad un prodotto inox (18/8) tridimensionale.

Peso specifico ridottissimo nonostante i volumi.

Varie sono le espressioni cromatiche dal colore tipico dell'inox lucido, spazzolato fino all'ultima generazione di colori high-tech.

The products of the INOX ZERO Collection are made out of stainless steel (18/8), utilising advanced production processes enabling the combination of expressive design with of low weight. A wide range of colours can be achieved, from timeless metallic shades to prestigious brushed and avant-garde colours.

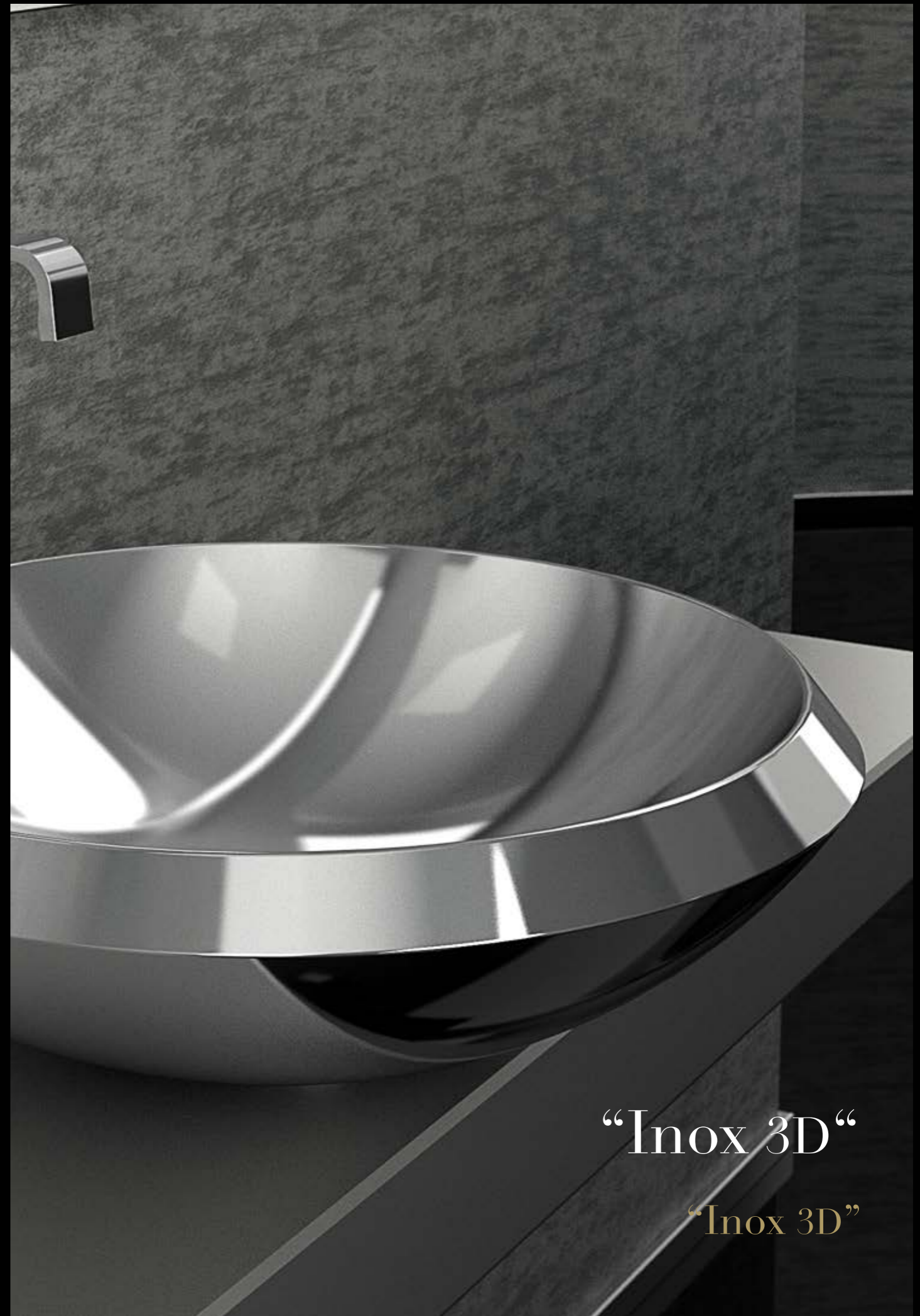

“Inox 3D”

“Inox 3D”



Mito

INOX
ZERO



MITO code MITOIL01



brevettato / patented

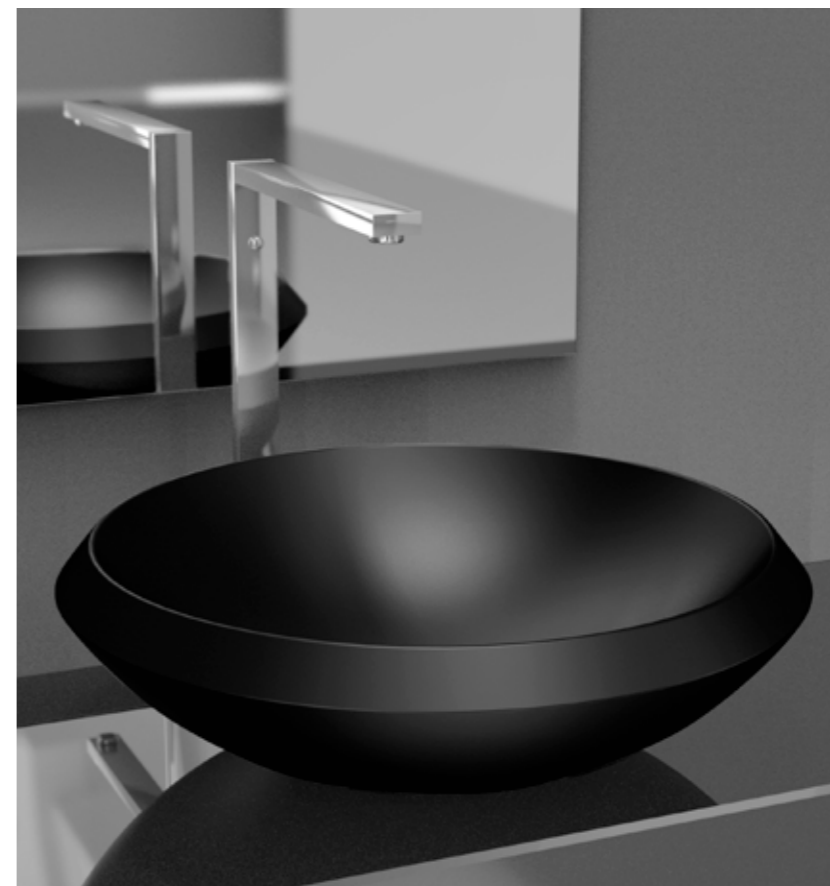

MITO code MITONO



brevettato / patented

design by **Studio ARIUS**

Glo Ball

INOX
ZERO



GLO BALL code GLOBALL01



brevettato / patented



GLO BALL code GLOBALBL



GLO BALL code GLOBALNO



brevettato / patented

design by **Studio ARIUS**

De Coste

INOX
ZERO



DE COSTE code DECOSTEIS01



brevettato / patented



DE COSTE code DECOSTEBL

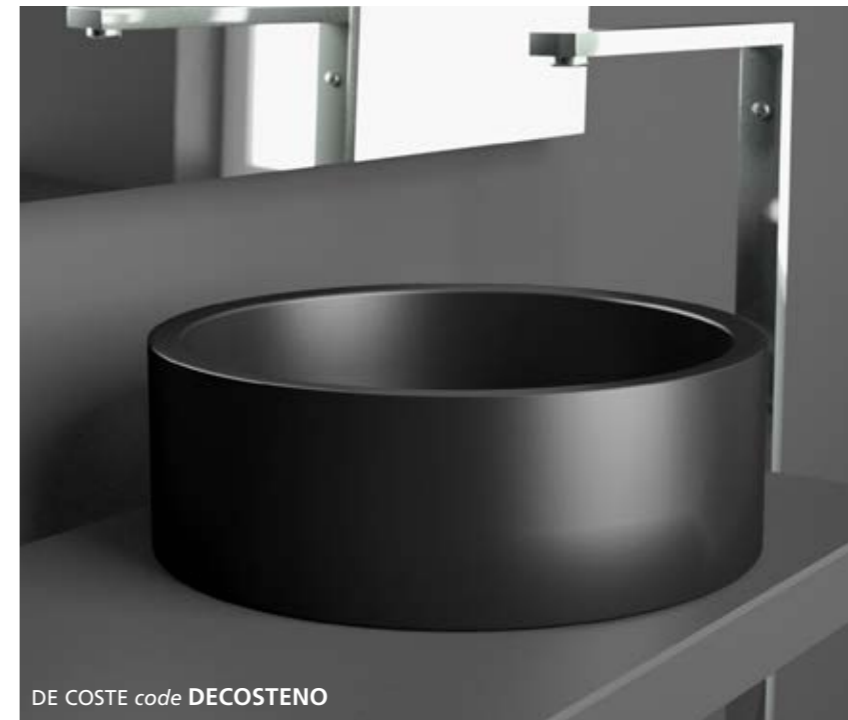

DE COSTE code DECOSTENO



brevettato / patented

design by **Studio ARIUS**

Siliconio®

Il design tattile, morbido, elastico, sensuale.
Touch and feel - soft and sensual.

Siliconio®, ultima generazione della famiglia dei siliconi. Via al design all'insegna dell'elasticità, dalle forme più rigorose che sfruttano le grandi potenzialità di questa materia, a quelle più bizzarre e originali. E' un materiale dalle forti sensazioni tattili: morbido, elastico, sensuale, unico. Siliconio®, quale materiale elastico, può essere sottoposto a torsioni, allungamenti e piegamenti ed in corso di rilascio torna alla sua forma originale. Siliconio® è idrorepellente, antinfortunistico, resistente a temperature tra -60°C e +250°C, lavabile, autoestinguento, atossico, dotato di resistenza chimica eccellente. Siliconio® è Touch design per eccellenza.

Siliconio®, is the latest development in the family of silicone materials. Featuring unique designs based on its elasticity, it allows for rigorous shapes, benefiting from the great potential of the material, being amongst the most unique and original. It is a material of touch: soft, elastic, sensual – simply unique. Siliconio® can be bent and folded in any possible way, always returning to its original form once released. Siliconio®, is water-repellent and, soft, thus reducing the risk of injury, but also resistant to extreme temperatures from -60°C to +250°C, washable, self-extinguishing, non-toxic and with excellent chemical resistance characteristics. Siliconio® is 'Touch design' at its very best.



“Touch design per eccellenza”

“Excellence you can touch and feel”

Barchetta

Light
Siliconio



BARCETTA LIGHT code **BARCHSL34L**

completo di illuminazione led e trasformatore
led lighting and transformer included



brevettato / patented

Barchetta

Siliconio



BARCETTA code **BARCHSL32**



BARCETTA code **BARCHSL30**



brevettato / patented

Gum

Siliconiò

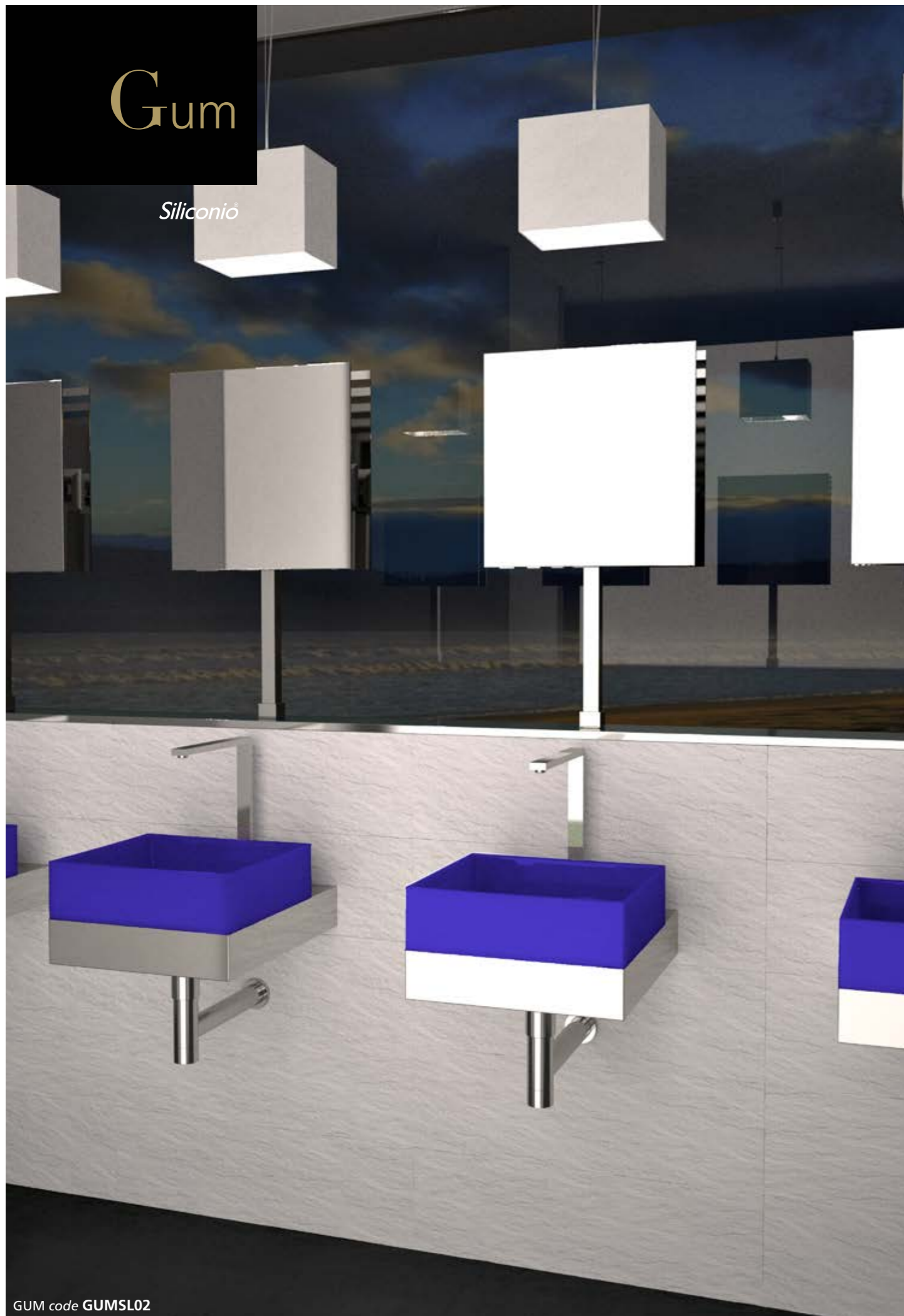

GUM code GUMSL02



brevettato / patented

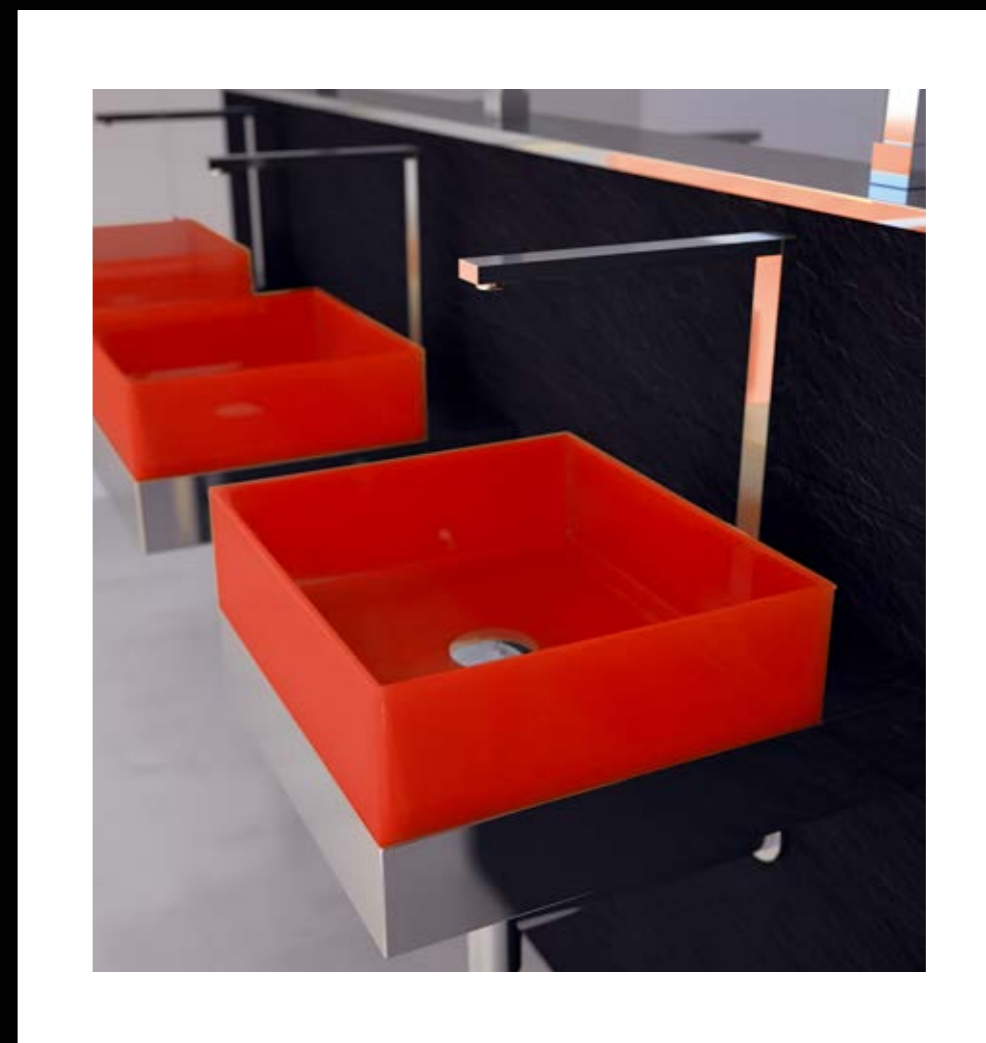

GUM code GUMSL34



brevettato / patented

design by **Studio ARIUS**



Tradizione senza tempo.
Timeless tradition.

La terra come fonte di ispirazione per rappresentare colorazioni e sensazioni tattili con finiture bicolore e texture esterne.

Terra di Siena una collezione di lavabi in ceramica realizzati interamente a mano. Lievi differenze cromatiche e imperfezioni di forma sono testimonianza dell'artigianalità del processo produttivo.

Earth is the source of inspiration for colours and tactile sensations with bi-colour finishes and textural exteriors.

The Terra di Siena collection of ceramic washbasins is made entirely by hand. Slight colour differences and shape imperfections are testimony to the craftsmanship of the production process.



Mode
Lux



MODE LUX code **MODE40MGD**



brevettato / patented

236



MODE LUX code **MODE40GMSL**



brevettato / patented

237

design by **Studio ARIUS**

Mode
Classic

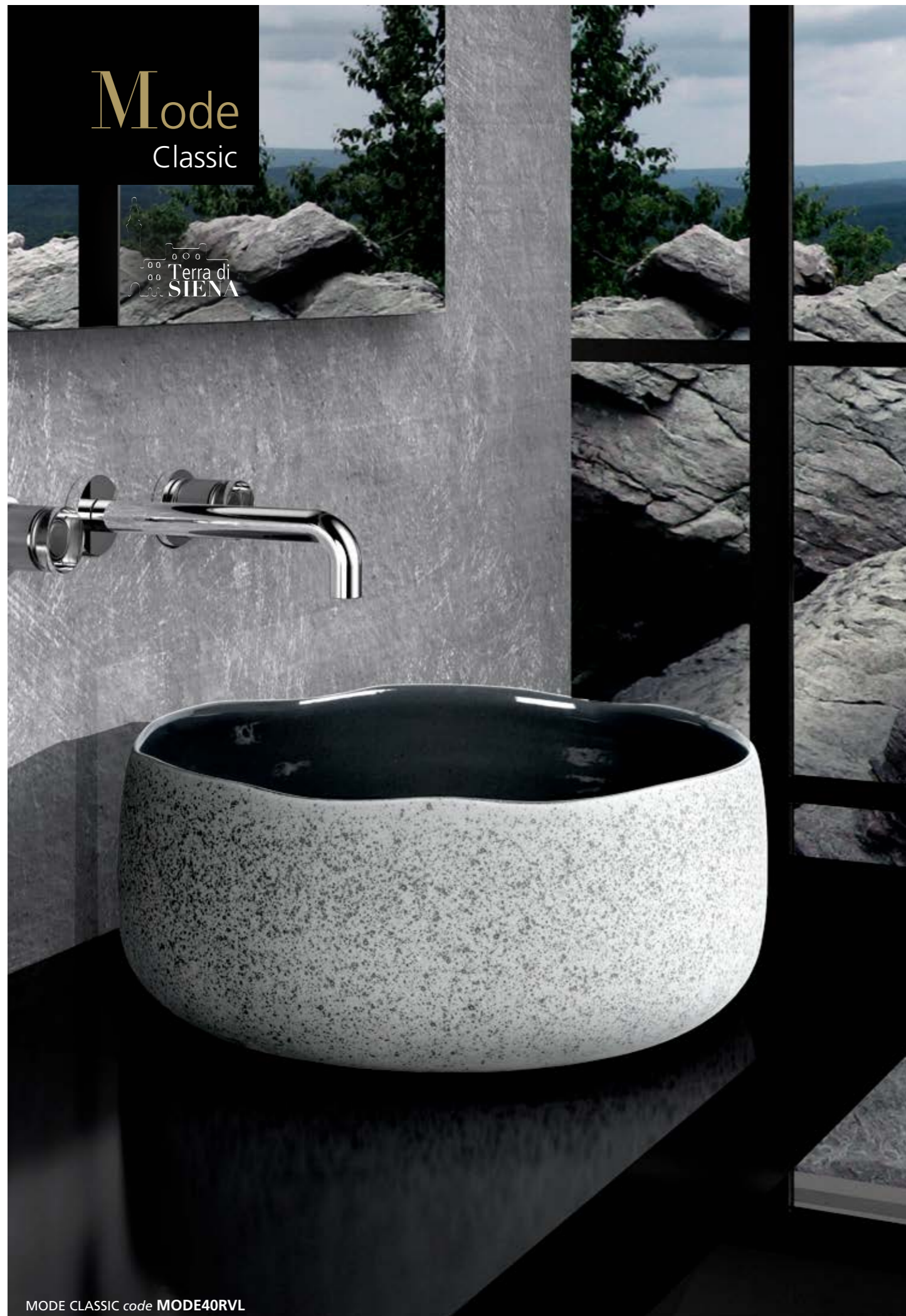

MODE CLASSIC code **MODE40RVL**



brevettato / patented

238



MODE CLASSIC code **MODE40RWT**



brevettato / patented

239

design by **Studio ARIUS**

Polo

Terra di
SIENA



POLO code POLO41RWT



brevettato / patented



POLO code POLO41RSN



brevettato / patented

design by Studio ARIUS

“accessori”
accessories

Valentino

Glass

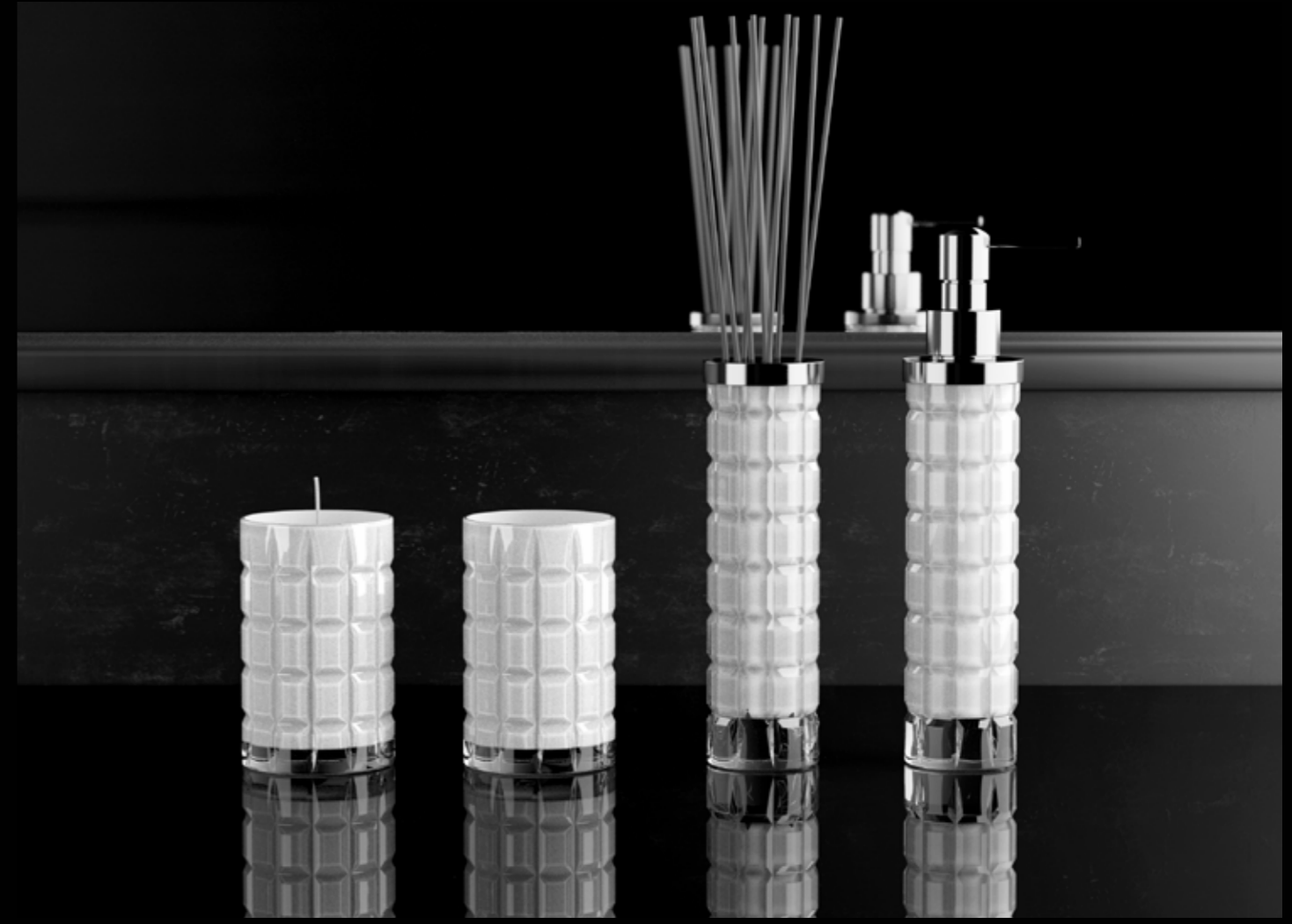
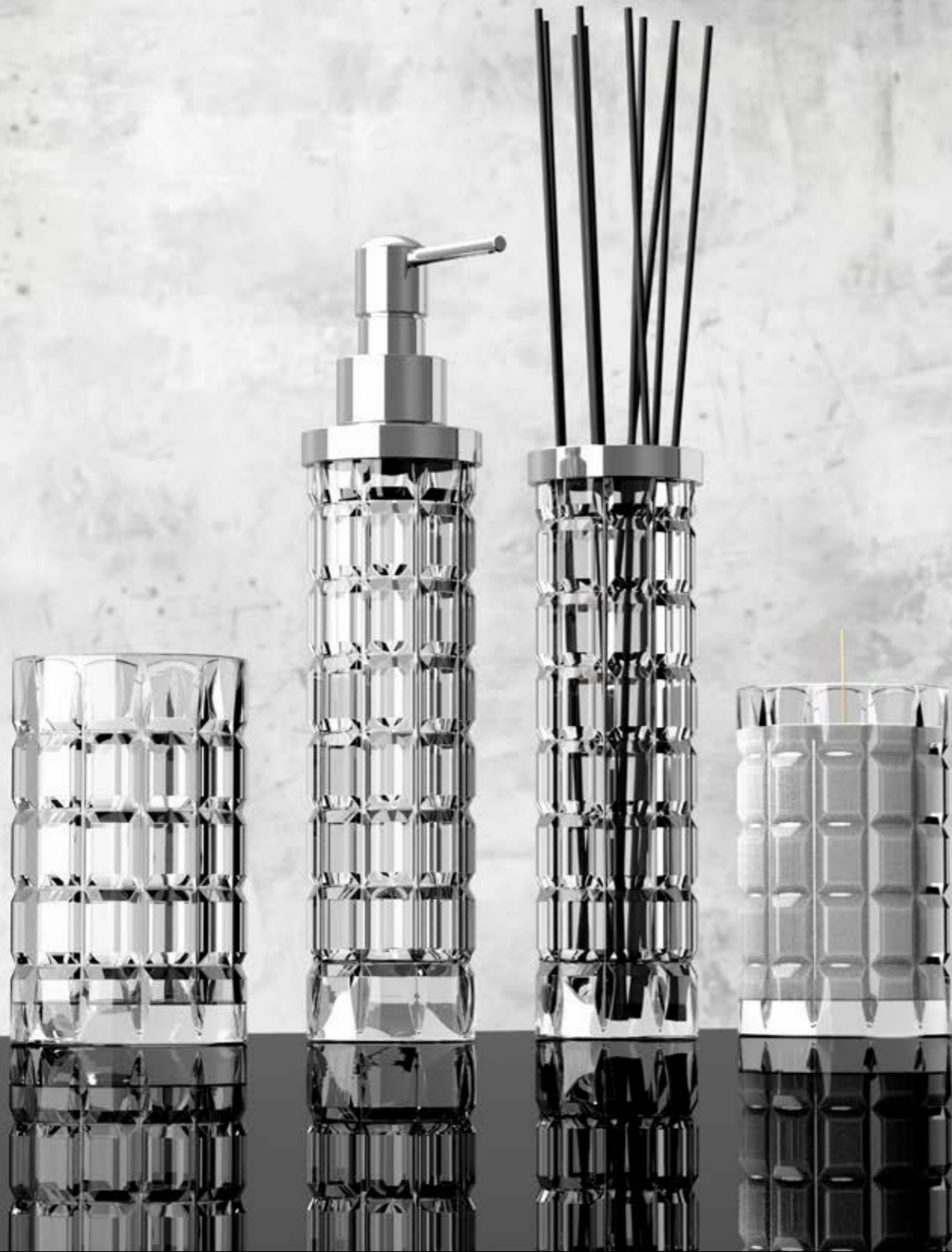

Tonda

Vetro Freddo®



Kleiss

Vetro Freddo®



Navy

Vetro Freddo®



Metropole

Vetro Freddo®



Colori

Glass

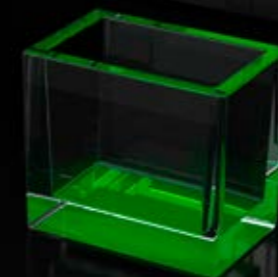
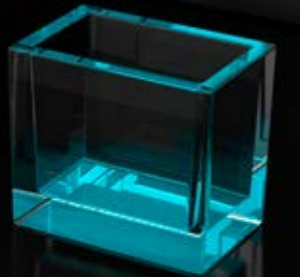
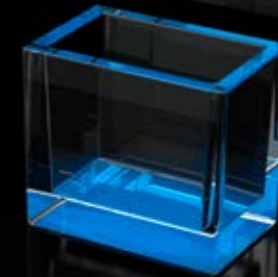

Colori Lux

Glass

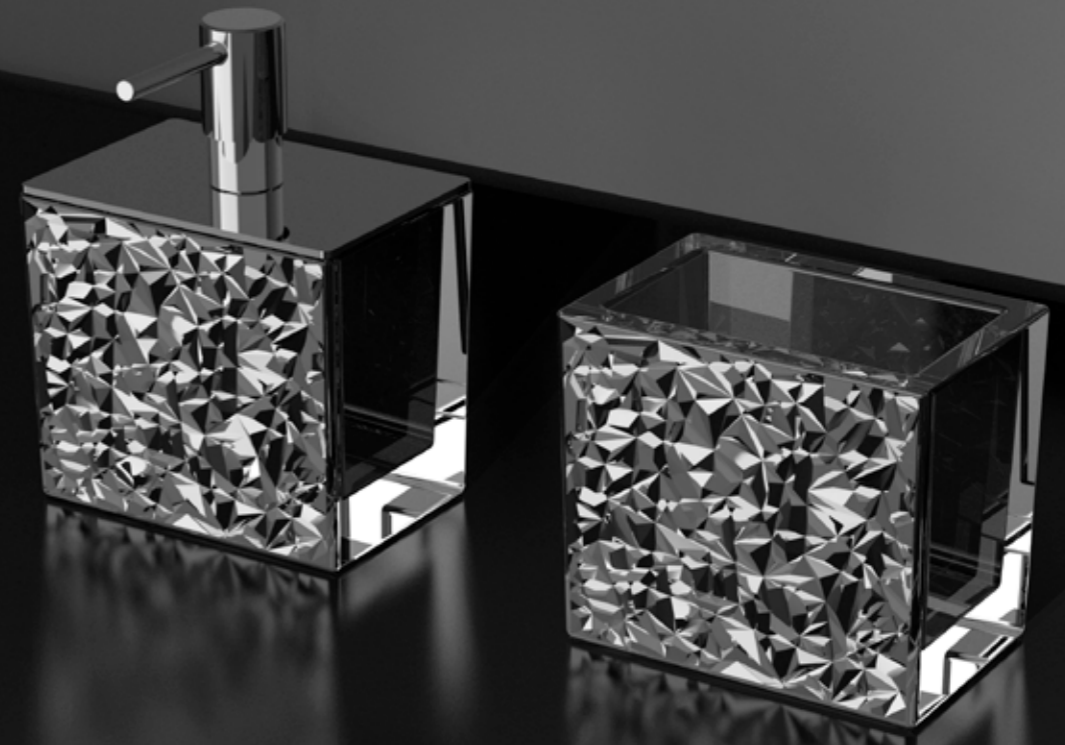

Luxury

Glass



Venice

Glass



Graffiti

Glass



Glamour

Alumix



Quadra

Alumix



Icissance



Icissance Luxor



Icissance

Collection

Icissance Ice



Icissance Ramada

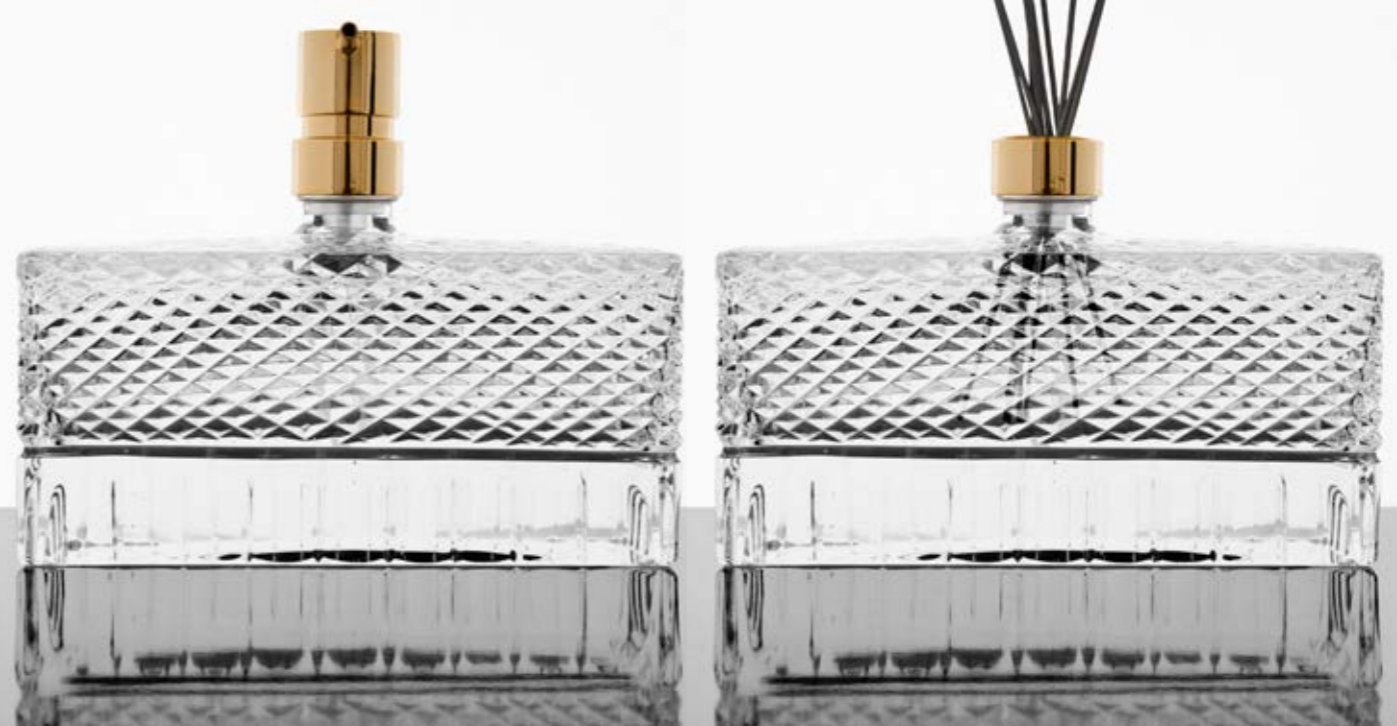

Drop essence Blue

Cristallo
DE MEDICI
Pd 24%



Drop essence Red



Drop essence Marine



Drop essence Yellow



Drop essence Turquoise



Drop essence Green



SPECIAL ONE

Luxury toilet brush



Opera Large

Cristallo
DE MEDICI
Pb 24%



Opera LARGE

clear / gold OPERALT01F3



brevettato / patented

Opera

Cristallo
DE MEDICI
Pb 24%



Opera SMALL
clear / chrome OPERAST01F4



Opera XL
clear / gold OPERAXLT01F3



brevettato / patented

Canto

Cristallo
DE MEDICI
Pb 24%



Canto SMALL
clear / chrome CANTOST01F4



Canto XL
clear / gold CANTOXLT01F3



brevettato / patented

“specifiche”
data sheet

“Il Cristallo: collezioni d'arte”
“The Crystal: art collections”

Dalle più antiche e nobili arti vetrarie.
From the ancient and noble glass arts.



Luxor Round



brevettato / patented

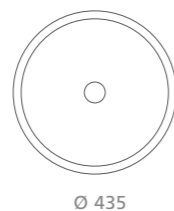

Ø 435

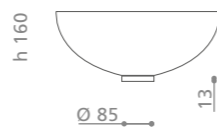

h 160

Ø 85

13

Ø foro / hole = 45 mm
peso / weight
lavabo / wash basin = 6,20 kg
piletta / waste = 0,35 kg
anello / ring basement = 0,42 kg



clear / chrome
LUXORROT01F4

code:

Base anello cromata e piletta inclusi Chrome waste and ring basement included



Villa



brevettato / patented

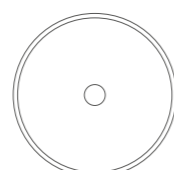

Ø 330



h 180

Ø foro / hole = 45 mm
peso / weight
lavabo / wash basin = ± 9 kg
piletta / waste = 0,35 kg



clear / chrome
VILLAT01F4

code:

Piletta cromata inclusa Chrome waste included



Collier



brevettato / patented

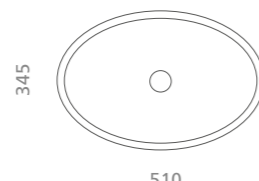

510



h 185

Ø foro / hole = 45 mm
peso / weight
lavabo / wash basin = 7,35 kg
piletta / waste = 0,35 kg



black with clear crystal base
COLLIERT30F4

code:

Base in cristallo e piletta cromata inclusi Crystal basement and chrome waste included



Ice Oval



brevettato / patented

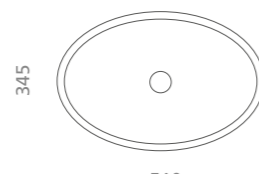

510

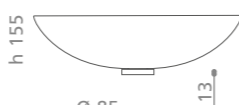

h 155

Ø 85

13

Ø foro / hole = 45 mm
peso / weight
lavabo / wash basin = 6,80 kg
piletta / waste = 0,35 kg
anello / ring basement = 0,42 kg



clear / chrome
ICEOVT01F4

code:



bluemarine / chrome
ICEOVT20F4



white gloss / chrome
ICEOVBLF4

Base anello cromata e piletta inclusi Chrome waste and ring basement included



Ice Oval Lux



brevettato / patented

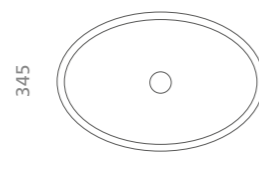

510

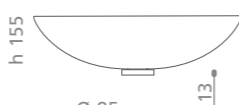

h 155

Ø 85

13

Ø foro / hole = 45 mm
peso / weight
lavabo / wash basin = 6,80 kg
piletta / waste = 0,35 kg
anello / ring basement = 0,42 kg



silver / chrome
ICEOVSLF4

code:



gold / chrome
ICEOVGDF4



gold / gold
ICEOVGDF3



platinum / chrome
ICEOVPLF4



rose gold / chrome
ICEOVPGF4

Base anello e piletta inclusi Waste and ring basement included



Ice Round



brevettato / patented

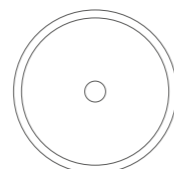

Ø 435

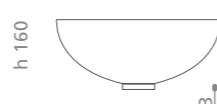

h 160

Ø 85

13

Ø foro / hole = 45 mm
peso / weight
lavabo / wash basin = 6,20 kg
piletta / waste = 0,35 kg
anello / ring basement = 0,42 kg



clear / chrome
ICEROT01F4

code:

Base anello cromata e piletta inclusi Chrome waste and ring basement included

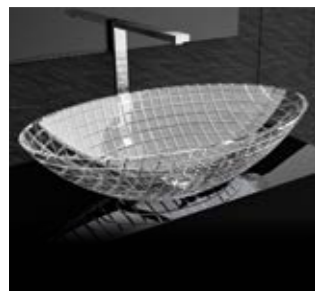

Luxor Oval

Cristallo DE' MEDICI Pb 24%

brevettato / patented

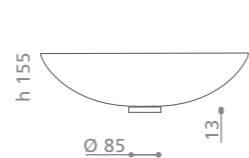
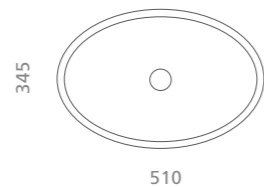

Ø foro / hole = 45 mm
peso / weight
lavabo / wash basin = 6,80 kg
piletta / waste = 0,35 kg
anello / ring basement = 0,42 kg

code:

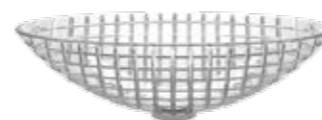

clear / chrome
LUXOROV1F4



bluemarine / chrome
LUXOROV20F4



white gloss / chrome
LUXOROVBLF4

Base anello cromata e piletta inclusi Chrome waste and ring basement included



Clivia

Cristallo DE' MEDICI Pb 24%

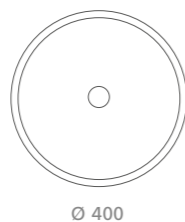

Ø foro / hole = 45 mm
peso / weight = 6,70 kg

code:



clear
CLIVIAT01



black
CLIVIAT35



Chelo

Cristallo DE' MEDICI Pb 24%

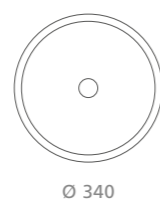

Ø foro / hole = 45 mm
peso / weight = 7,50 kg

code:



clear
CHELOT01



black
CHELOT30



Aqua

Cristallo DE' MEDICI Pb 24%

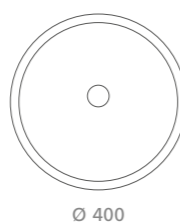

Ø foro / hole = 45 mm
peso / weight = 6,70 kg

code:



clear
AQUAT01



black
AQUAT30



Moon

Cristallo DE' MEDICI Pb 24%

brevettato / patented

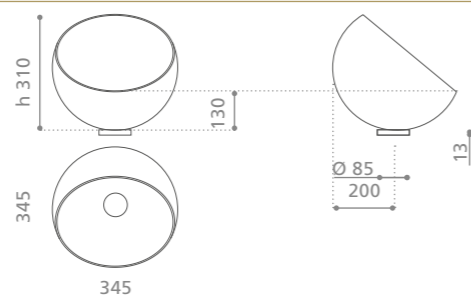

Ø foro / hole = 45 mm
peso / weight
lavabo / wash basin = 8,90 kg
piletta / waste = 0,35 kg
anello / ring basement = 0,42 kg

code:



clear / chrome
MOONT01F4

Base anello cromata e piletta inclusi Chrome waste and ring basement included



Ramada Lux

Cristallo DE' MEDICI Pb 24%

brevettato / patented

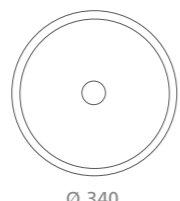

Ø foro / hole = 45 mm
peso / weight
lavabo / wash basin = 7,50 kg
piletta / waste = 0,35 kg
anello / ring basement = 0,42 kg

code:



silver / chrome
RAMADASLF4



gold / chrome
RAMADAGDF4



gold / gold
RAMADAGDF3



platinum / chrome
RAMADAPLF4



rose gold / chrome
RAMADAPGF4

Base anello e piletta inclusi Waste and ring basement included



Ramada

Cristallo DE' MEDICI Pb 24%

brevettato / patented

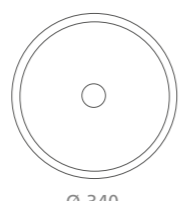

Ø foro / hole = 45 mm
peso / weight
lavabo / wash basin = 7,50 kg
piletta / waste = 0,35 kg
anello / ring basement = 0,42 kg

code:



clear / chrome
RAMADAT01F4

Base anello cromata e piletta inclusi Chrome waste and ring basement included





Moon Over Ice



brevettato / patented

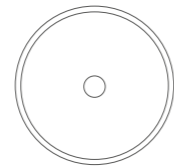

Ø 395

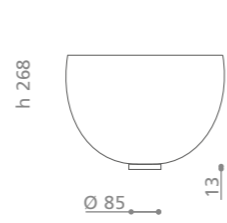

Ø foro / hole = 45 mm
peso / weight
lavabo / wash basin = 6,90 kg
piletta / waste = 0,35 kg
anello / ring basement = 0,42 kg

code:



clear / chrome
MOONOVICET01F4

Base anello cromata e piletta inclusi Chrome waste and ring basement included



Glo Ball Crystal Ice



brevettato / patented

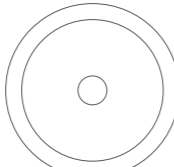

Ø 445

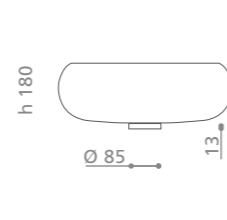

Ø foro / hole = 45 mm
peso / weight
lavabo / wash basin = ±7,10 kg
piletta / waste = 0,35 kg
anello / ring basement = 0,42 kg

code:



clear / chrome
GLOBALLICET01F4

Base anello cromata e piletta inclusi Chrome waste and ring basement included



Glo Ball Crystal Ramada



brevettato / patented

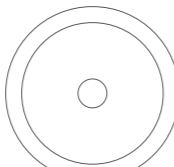

Ø 445

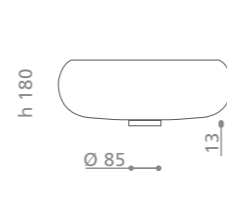

Ø foro / hole = 45 mm
peso / weight
lavabo / wash basin = ±8,20 kg
piletta / waste = 0,35 kg
anello / ring basement = 0,42 kg

code:



clear / chrome
GLOBALRAMT01F4

Base anello cromata e piletta inclusi Chrome waste and ring basement included

made with
MURANO[®]
glass

“Il privilegio dell’inimitabile”
“The privilege of individualism”

Dalla tradizione millenaria un oggetto unico e prestigioso.
Creating masterpieces with artisan traditions.



Isola Small



design by:
ALESSANDRO LENARDA
brevettato / patented

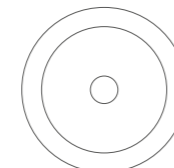

Ø 460

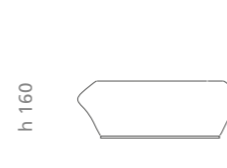

Ø foro / hole = 45 mm
peso / weight = 4,70 kg

code:



opal white
ISOLASMT36



mat opal white
ISOLASMS36

Piletta abs e base in vetrofreddo incluse
Illuminazione led e trasformatore inclusi
ABS waste and vetrofreddo basement included
Led lighting and transformer included

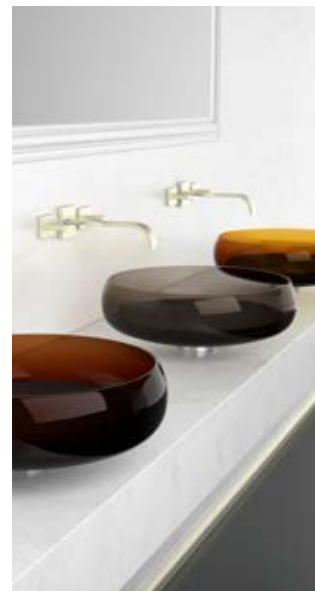

Glo Ball Murano



brevettato / patented

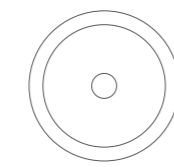

Ø 420

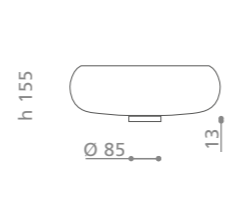

carabotto
cover

Ø 365

Ø foro / hole = 45 mm
peso / weight
lavabo / wash basin = 5,20 kg
piletta / waste = 0,35 kg
anello / ring basement = 0,42 kg

code:



amber / chrome
GLOBALLMT05F4



fumè / chrome
GLOBALLMT43F4



cognac / chrome
GLOBALLMT33F4



opal white / chrome
GLOBALLMT36F4



black mat cover in Pert[®]
INCLUDED



black mat cover in Pert[®]
INCLUDED



black mat cover in Pert[®]
INCLUDED



white mat cover in Pert[®]
INCLUDED

Base anello cromata, piletta e cover in Pert inclusi
Chrome waste, ring basement and cover in Pert included
Realizzato a mano da maestri vetrai muranesi secondo le più rinomate tradizioni.
Eventuali piccole imperfezioni e variazioni di forma e colore sono testimonianza dell'artigianalità del processo produttivo.
Handmade by master glassmakers of Murano according to the most ancient and noble glass arts.
Any slight imperfections and variations in shape and colour highlight the craftsmanship of the production process.



I colori rappresentati in stampa si intendono puramente indicativi. - Print colors of the wash basins may vary slightly from original color.



Laguna Blue

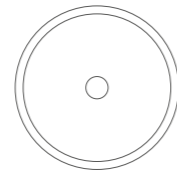

Ø 410

h 175

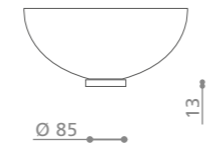

Ø 85

Ø foro / hole = 45 mm
peso / weight
lavabo / wash basin = 4,70 kg
piletta / waste = 0,35 kg
anello / ring basement = 0,42 kg

code:



blue transparent / chrome
LAGUNAT42F4

Base anello cromata e piletta inclusi
Chrome waste and ring basement included



Laguna Night

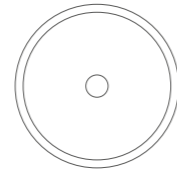

Ø 410

h 175

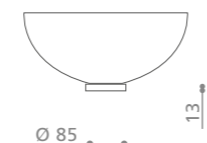

Ø 85

Ø foro / hole = 45 mm
peso / weight
lavabo / wash basin = 4,70 kg
piletta / waste = 0,35 kg
anello / ring basement = 0,42 kg

code:



brown / chrome
LAGUNAT33F4

Base anello cromata e piletta inclusi
Chrome waste and ring basement included



Laguna Oro

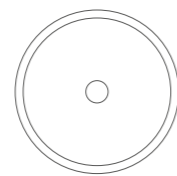

Ø 410

h 175

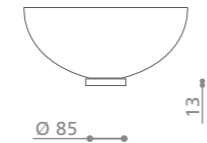

Ø 85

Ø foro / hole = 45 mm
peso / weight
lavabo / wash basin = 6,30 kg
piletta / waste = 0,35 kg
anello / ring basement = 0,42 kg

code:



clear - gold leaf / chrome
LAGUNAGDF4



clear - gold leaf / gold
LAGUNAGDF3

Base anello e piletta inclusi
Waste and ring basement included



Laguna Red

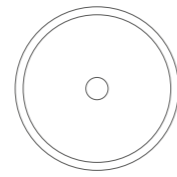

Ø 410

h 175

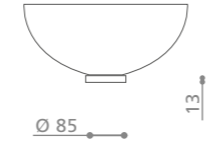

Ø 85

Ø foro / hole = 45 mm
peso / weight
lavabo / wash basin = 4,70 kg
piletta / waste = 0,35 kg
anello / ring basement = 0,42 kg

code:



red transparent / chrome
LAGUNAT16F4

Base anello cromata e piletta inclusi
Chrome waste and ring basement included



Laguna Vintage

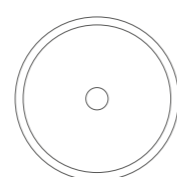

Ø 410

h 175

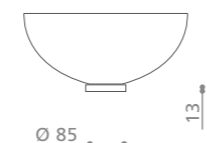

Ø 85

Ø foro / hole = 45 mm
peso / weight
lavabo / wash basin = 5,40 kg
piletta / waste = 0,35 kg
anello / ring basement = 0,42 kg

code:



red vintage / chrome
LAGUNAVNF4

Base anello cromata e piletta inclusi
Chrome waste and ring basement included



Laguna Smoke

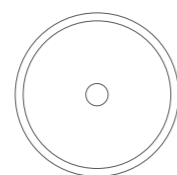

Ø 410

h 175

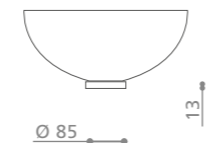

Ø 85

Ø foro / hole = 45 mm
peso / weight
lavabo / wash basin = 4,70 kg
piletta / waste = 0,35 kg
anello / ring basement = 0,42 kg

code:



smoke transparent / chrome
LAGUNAT43F4

Base anello cromata e piletta inclusi
Chrome waste and ring basement included





Canale

made with MURANO® glass

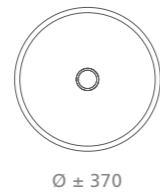

Ø ± 370

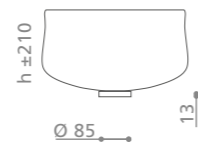

h ± 210

Ø 85

13

Ø foro / hole = 45 mm
peso / weight
lavabo / wash basin = 6,40 kg
piletta / waste = 0,35 kg
anello / ring basement = 0,42 kg

code:



white-black / chrome
CANALEWBF4

Base anello cromata e piletta inclusi
Chrome waste and ring basement included

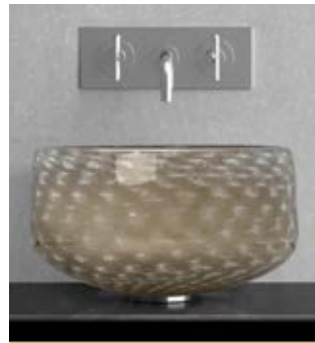

Ottico

made with MURANO® glass

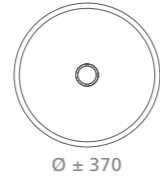

Ø ± 370

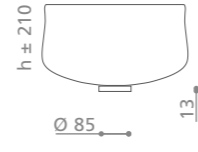

h ± 210

Ø 85

13

Ø foro / hole = 45 mm
peso / weight
lavabo / wash basin = 6,40 kg
piletta / waste = 0,35 kg
anello / ring basement = 0,42 kg

code:



grey-white / chrome
OTTICOGWF4

Base anello cromata e piletta inclusi
Chrome waste and ring basement included



Calla Black

made with MURANO® glass

design by:
MOGIODESIGN

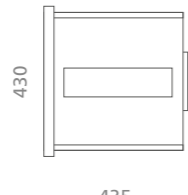

435

430

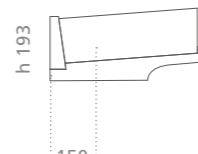

h 193

150

Ø foro / hole = 45 mm
peso / weight = 9,20 kg

code:



black - gold
CALLABG



black - silver
CALLABS

Supporto in VetroFreddo nero incluso
VetroFreddo black basement included



Calla

made with MURANO® glass

design by:
MOGIODESIGN

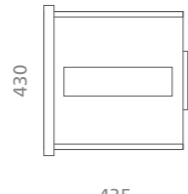

435

430

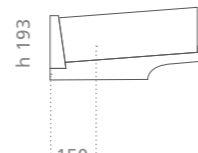

h 193

150

Ø foro / hole = 45 mm
peso / weight = 9,20 kg

code:



calla decor / white
CALLACR01



calla decor / black
CALLACR01BK

Supporto in VetroFreddo nero o bianco incluso
VetroFreddo black or white basement included



Arte Uno

made with MURANO® glass

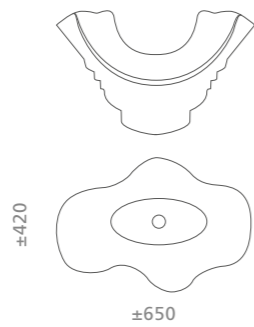

±420

±650

h ± 210

Ø foro / hole = 45 mm
peso / weight = 8,40 kg

code:



clear / gold leaf 3d
ARTEUNOFO

Piletta cromata inclusa
Chrome waste included



Arte Due

made with MURANO® glass

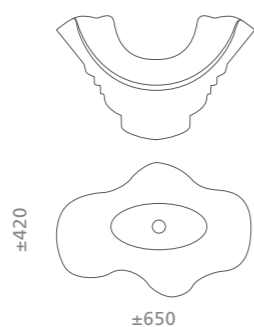

±420

±650

h ± 210

Ø foro / hole = 45 mm
peso / weight = 8,40 kg

code:



black / gold leaf 3d
ARTEDUENFO

Piletta cromata inclusa
Chrome waste included



I colori rappresentati in stampa si intendono puramente indicativi. - Print colors of the wash basins may vary slightly from original color.



Arte Tre

made with MURANO® glass

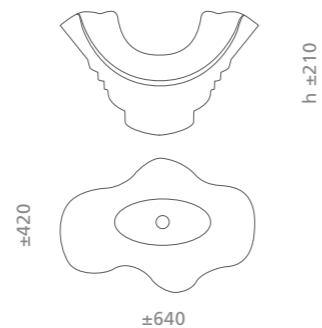

Ø foro / hole = 45 mm
peso / weight = 8,40 kg

code:

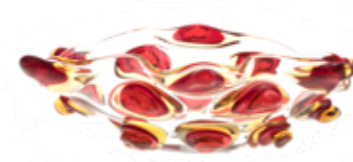

red / amber beads
ARTETRETD

Piletta cromata inclusa
Chrome waste included



Arte Quattro

made with MURANO® glass

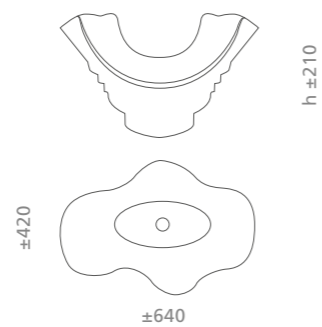

Ø foro / hole = 45 mm
peso / weight = 8,40 kg

code:

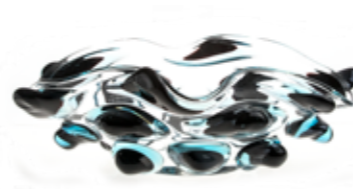

blue / black beads
ARTEQUATTRBB

Piletta cromata inclusa
Chrome waste included



Gondola

made with MURANO® glass

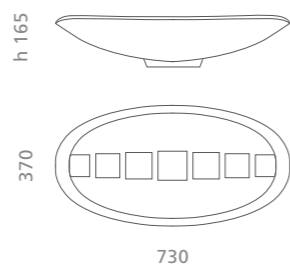

Ø foro / hole = 45 mm
peso / weight = 6,60 kg

code:



gondola decor
GONDOLATX01

Supporto in VetroFreddo nero e piletta inclusi
VetroFreddo black basement and chrome waste included

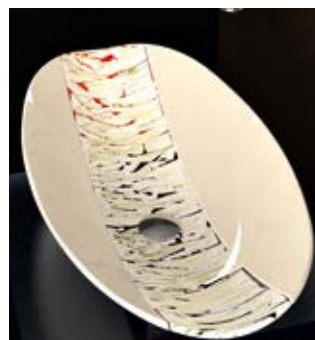

Carnival

made with MURANO® glass

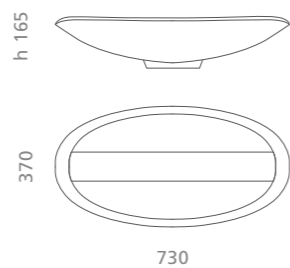

Ø foro / hole = 45 mm
peso / weight = 6,60 kg

code:



carnival decor
CARNIVALCR01

Supporto in VetroFreddo nero e piletta inclusi
VetroFreddo black basement and chrome waste included

“Quando l’arte
incontra la natura”
“When art ,eets nature”

La metamorfosi della materia.
The metamorphosis of matter.



Air



brevettato / patented

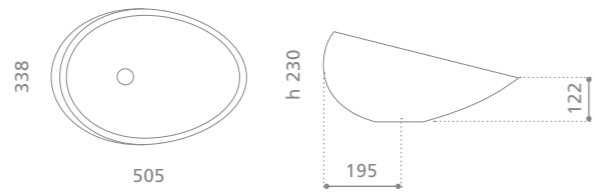

Ø foro / hole = 45 mm
peso / weight = 11 kg

code:



white calacatta
AIRMARW

Piletta cromata inclusa
Chrome waste included



Kool Max



brevettato / patented

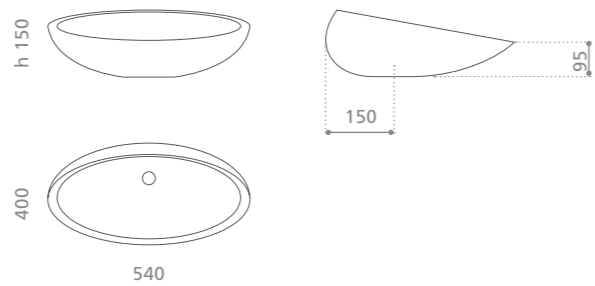

Ø foro / hole = 45 mm
peso / weight = 9,40 kg

code:



white calacatta
KOOLMAXMARW

Piletta cromata inclusa
Chrome waste included

“Forme e design senza limiti”
“Shapes and design without limits”

L’ esaltazione della materia attraverso l’anima del suo colore.
A unique material. Expressive colours.



Kool
Vetro Freddo®

brevettato / patented

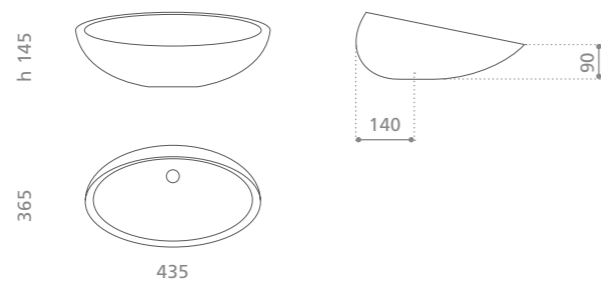

Ø foro / hole = 45 mm
peso / weight = 5,50 kg

code:



white mat
KOOLPO01

black mat
KOOLPO30

moka mat
KOOLPO33

cognac
KOOLTO35

red-mat
KOOLTO34

Ferrari red
KOOLPL34

code:



silver leaf 3d
KOOLFA



gold leaf 3d
KOOLFO



copper leaf 3d
KOOLFR



platinum
KOOLPL



Kool max

Vetro Freddo®

brevettato / patented

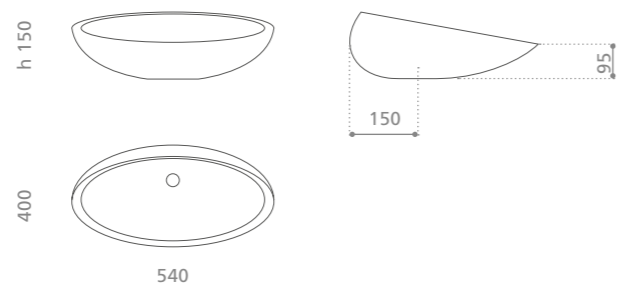

Ø foro / hole = 45 mm
peso / weight = 6,50 kg

code:



code:



Kool XL

Vetro Freddo®

brevettato / patented

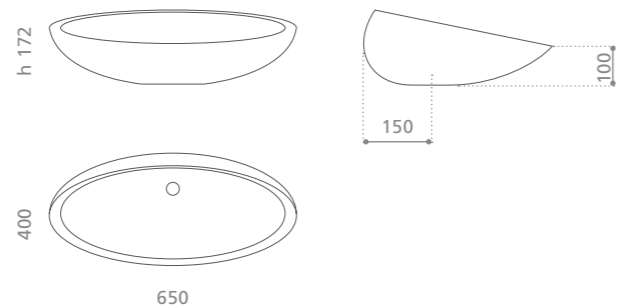

Ø foro / hole = 45 mm
peso / weight = 6,70 kg

code:



code:



Kool oversize

Vetro Freddo®

brevettato / patented

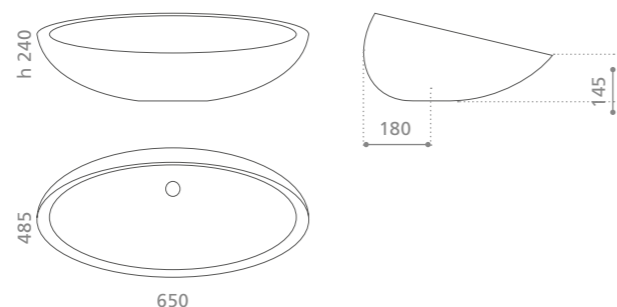

Ø foro / hole = 45 mm
peso / weight = 6,70 kg

code:



code:



Air

Vetro Freddo®

brevettato / patented

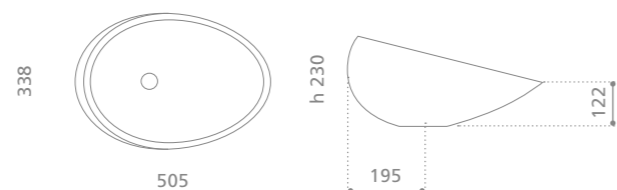

Ø foro / hole = 45 mm
peso / weight = 6,30 kg

code:

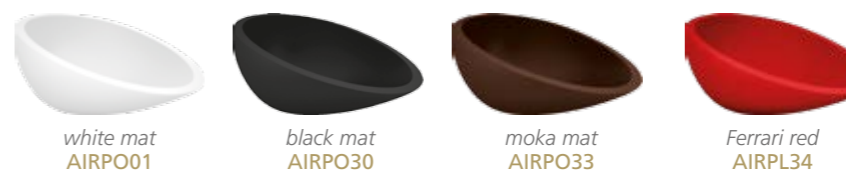

code:

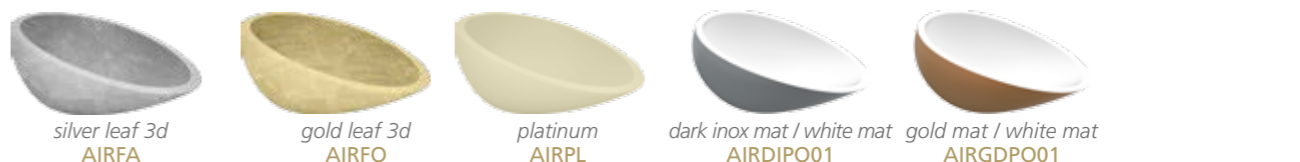

Infinity over

Vetro Freddo®

design by: MOGIODESIGN

brevettato / patented

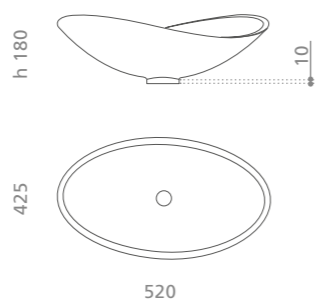

Ø foro / hole = 45 mm
peso / weight = 6,60 kg

code:

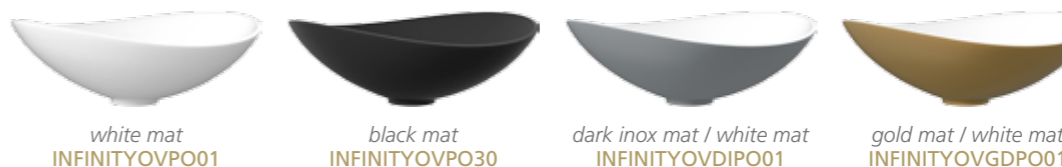

code:

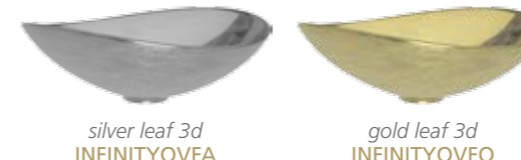

I colori rappresentati in stampa si intendono puramente indicativi. - Print colors of the wash basins may vary slightly from original color.



Collina
Vetro Freddo®

brevettato / patented

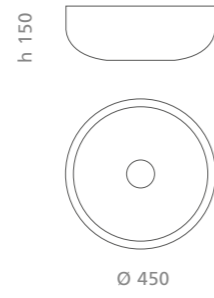

Ø foro / hole = 45 mm
peso / weight = 10,80 kg

code:



white mat
COLLINAPO01



black mat
COLLINAPO30



dark inox mat / white mat
COLLINADIPO01



gold mat / white mat
COLLINAGDPO01



Ala 80
Vetro Freddo®

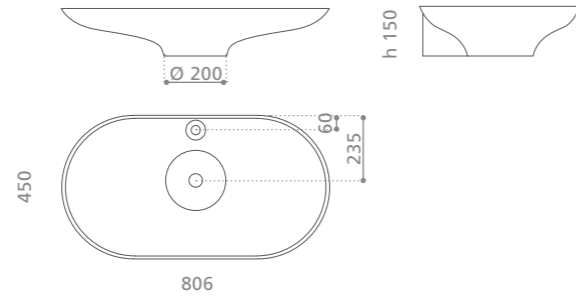

Ø foro / hole = 45 mm
peso / weight = 7,10 kg

code:



white mat
ALA80PO01



black mat
ALA80PO30



dark inox mat / white mat
ALA80DIPO01



gold mat / white mat
ALA80GDPO01



Ala 100
Vetro Freddo®

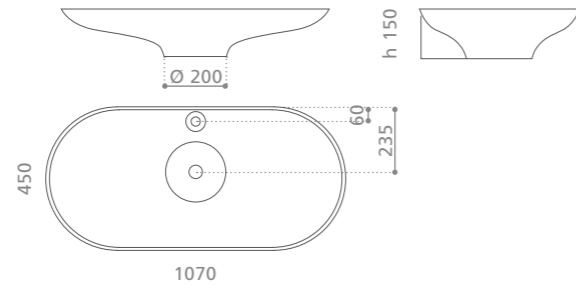

Ø foro / hole = 45 mm
peso / weight = 9,20 kg

code:



white mat
ALA100PO01



black mat
ALA100PO30



dark inox mat / white mat
ALA100DIPO01



gold mat / white mat
ALA100GDPO01



Play
Vetro Freddo®

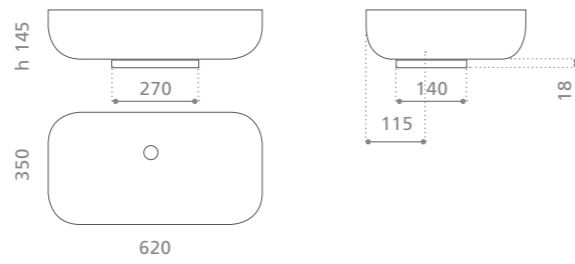

Ø foro / hole = 45 mm
peso / weight = 11,50 kg

code:



white
PLAYPO01



black
PLAYPO30



white gloss
PLAYPL01



black gloss
PLAYPL30



Net
Vetro Freddo®

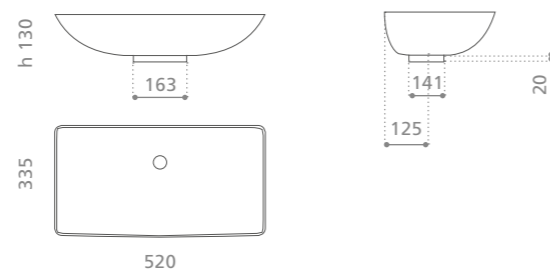

Ø foro / hole = 45 mm
peso / weight = 4,50 kg

code:



white mat
NETPO01



black mat
NETPO30



silver leaf 3D
NETFA



gold leaf 3D
NETFO



copper leaf 3D
NETFR



bluemarine
NETTO02



green mat
NETTO32



cognac
NETTO35



red mat
NETTO34



Stone
Vetro Freddo®

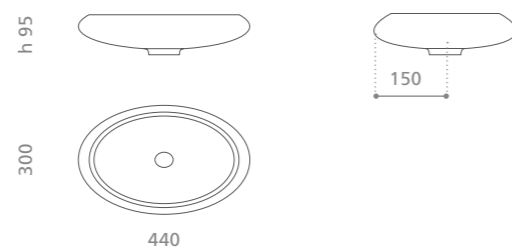

Ø foro / hole = 45 mm
peso / weight = 2,50 kg

code:



white mat
STONEPO01



black mat
STONEPO30



moka mat
STONEPO33



cognac
STONETO35



red mat
STONETO34



bluemarine
STONETO02



Cocoon Metal
TeknoForm®

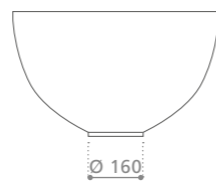
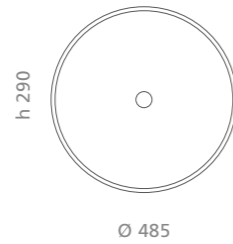

Ø foro / hole = 45 mm
peso / weight = 6,40 kg



code: brushed dark inox / white mat
COCOONDIPO01



code: brushed gold / white mat
COCOONGDPO01



code: brushed platinum / white mat
COCOONPLPO01



Cocoon Lux
TeknoForm®

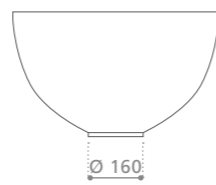
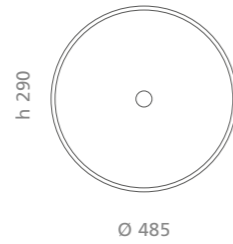

Ø foro / hole = 45 mm
peso / weight = 6,40 kg



code: silver leaf 3d / white mat
COCOONFAPO01



code: gold leaf 3d / white mat
COCOONFOPO01



Cocoon Materic
TeknoForm®

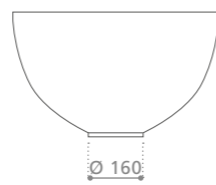
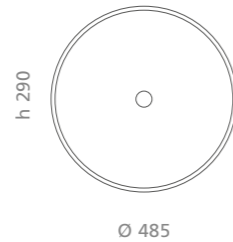

Ø foro / hole = 45 mm
peso / weight = 6,40 kg



code: white mat
COCOONPO01



code: grey mat
COCOONGR



code: beige mat
COCOONBG



code: tortora mat
COCOONTR



code: white gloss
COCOONBL



Mosaic
TeknoForm®
brevettato / patented

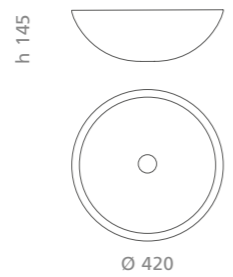

Ø foro / hole = 45 mm
peso / weight = 6,00 kg



code: white mat
MOSAICPO01



code: black mat
MOSAICPO30



code: silver leaf 3d
MOSAICFA



code: gold leaf 3d
MOSAICFO



code: copper leaf 3d
MOSAICFR



Circus 50
TeknoForm®

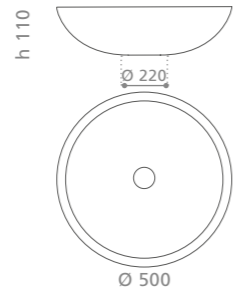

Ø foro / hole = 45 mm
peso / weight = 9,00 kg



code: white mat
CIRCUS50PO01



code: black mat
CIRCUS50PO30



code: silver leaf 3d
CIRCUS50FA



code: gold leaf 3d
CIRCUS50FO



code: copper leaf 3d
CIRCUS50FR



Circus 43
TeknoForm®

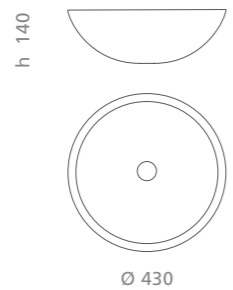

Ø foro / hole = 45 mm
peso / weight = 7,00 kg



code: white mat
CIRCUS43PO01



code: black mat
CIRCUS43PO30



code: silver leaf 3d
CIRCUS43FA



code: gold leaf 3d
CIRCUS43FO



code: copper leaf 3d
CIRCUS43FR



Circus 43
travertino
TeknoForm®

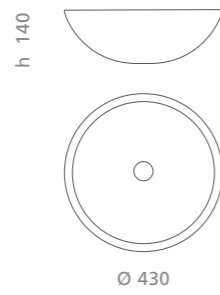

Ø foro / hole = 45 mm
peso / weight = 7,00 kg

code:



white travertino
CIRCUS43ST01



black travertino
CIRCUS43ST30



natural travertino
CIRCUS43ST31



Oval
travertino
TeknoForm®

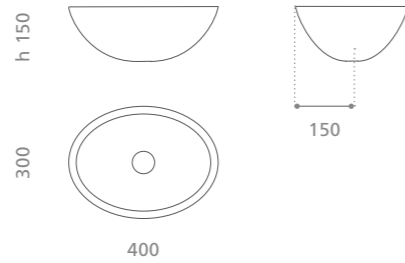

Ø foro / hole = 45 mm
peso / weight = 5,80 kg

code:



white travertino
OVALST01



black travertino
OVALST30



natural travertino
OVALST31



Rapolano
TeknoForm®

brevettato / patented

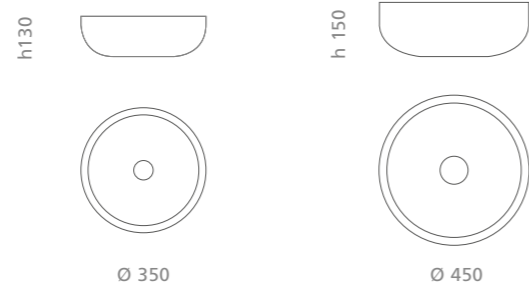

RAPOLANO 35
Ø foro / hole = 35 mm
peso / weight = 5,50 kg

RAPOLANO 45
Ø foro / hole = 45 mm
peso / weight = 10,80 kg

code:



natural travertino
RAP35ST



white travertino
RAP35B



black travertino
RAP35ST30



cotto
RAP35TC



natural travertino
RAP45ST



white travertino
RAP45B



black travertino
RAP45ST30



cotto
RAP45TC



Roma
TeknoForm®

design by:
CAIROLI-DONZELLI

brevettato / patented

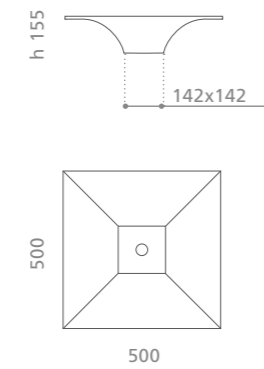

Ø foro / hole = 45 mm
peso / weight = 7,20 kg

code:



white gloss
ROMAPL01



black mat
ROMAPO30



Ferrari red
ROMAPL34



beige
ROMABG



grey
ROMAGR



tortora
ROMATR



gold leaf 3d
ROMAFO



silver leaf 3d
ROMAFA

“Collezione d’arte futurista”
“The avant-garde collection”

Leggerezza e design sposano la tecnologia.
Light weight, spectacular design, innovative technology.



FLOwer

Pert[®]

design by:
MARCO PISATI

brevettato / patented

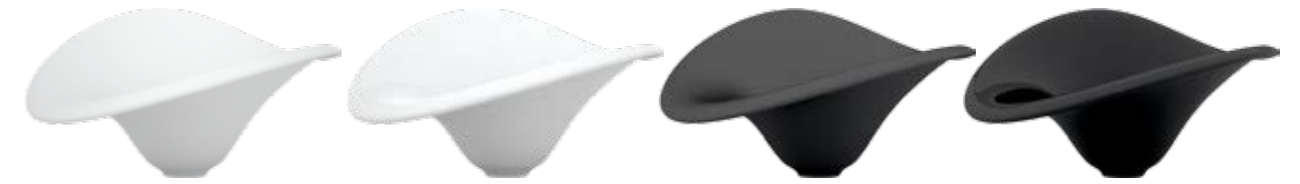
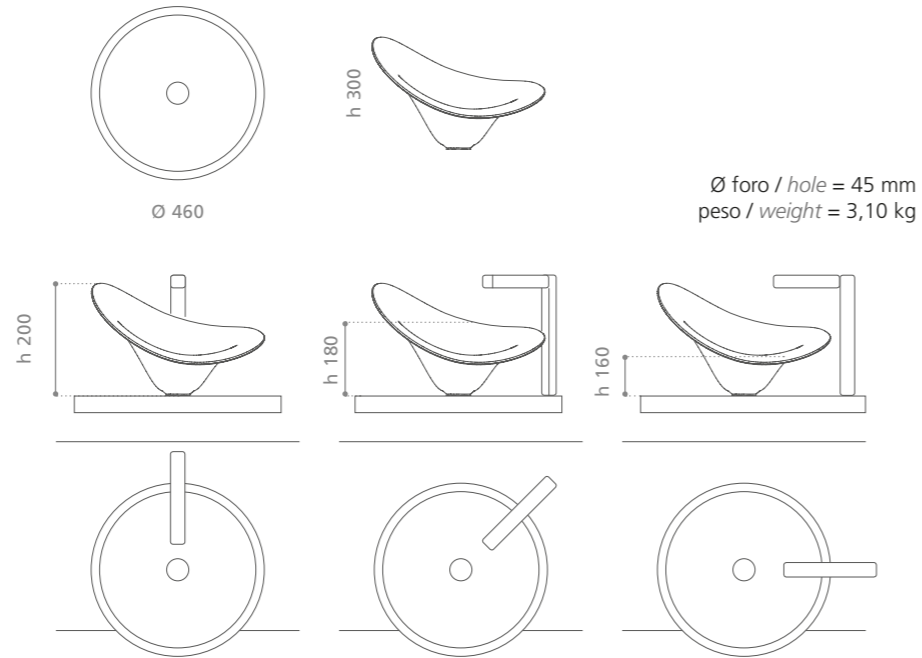

code:

white mat
FLOP31

white gloss
FLOBL

black mat
FLOP30

black gloss
FLO402



code:

platinum
FLOPL

Ferrari red
FLOPL34

silver leaf 3d
FLOFA

gold leaf 3d
FLOFO

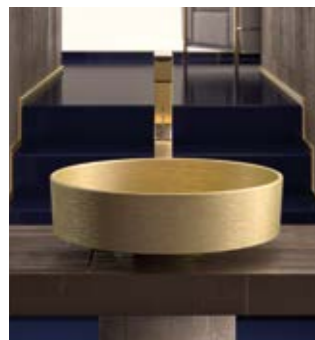

Rho metal

Pert[®]

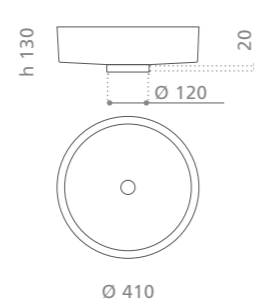

Ø foro / hole = 45 mm
peso / weight = 4,65 kg

code:



brushed gold
RHOGD



brushed platinum
RHOPL



brushed dark inox
RHODI



brushed copper
RHOCP



Rho lux

Pert[®]

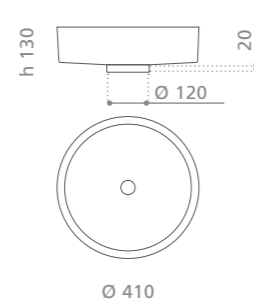

Ø foro / hole = 45 mm
peso / weight = 4,65 kg

code:



silver leaf 3d
RHOF A



gold leaf 3d
RHOF O



Rho vision

Pert[®]

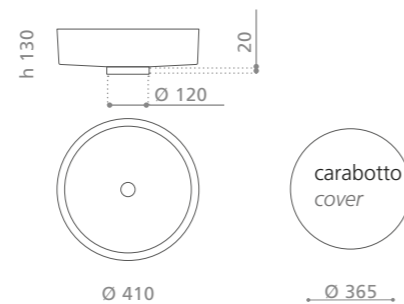

Ø foro / hole = 45 mm
peso / weight = 6,15 kg

code:



white mat
RHOB O



black mat
RHONO



old copper
RHOCPO



old bronze
RHOBZO



Rho starlight

Pert®

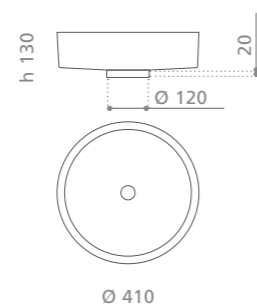

Ø foro / hole = 45 mm
peso / weight = 4,65 kg

code:



white starlight
RHOLH01



black starlight
RHOLH30



grey starlight
RHOLH43



champagne starlight
RHOLH05



Four starlight

Pert®

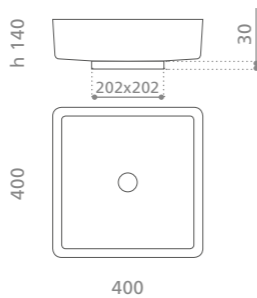

Ø foro / hole = 45 mm
peso / weight = 4,65 kg

code:



white starlight
FOURLH01



black starlight
FOURLH30



grey starlight
FOURLH43



champagne starlight
FOURLH05



Four lux

Pert®

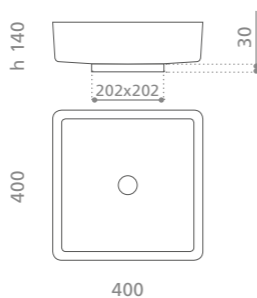

Ø foro / hole = 45 mm
peso / weight = 4,65 kg

code:



silver leaf 3d
FOURFA



gold leaf 3d
FOURFO



Four vision

Pert®

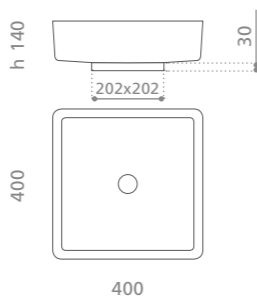

Ø foro / hole = 45 mm
peso / weight = 6,14 kg

code:



white mat
FOURBO



black mat
FOURNO



Blade vision

Pert®

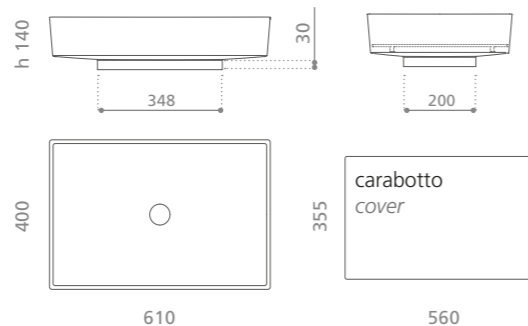

Ø foro / hole = 45 mm
peso / weight = 8,50 kg

code:



white mat
BLADEBO



black mat
BLADENO





Infinity colour

Pert®

design by:
MOGIODESIGN

brevettato / patented

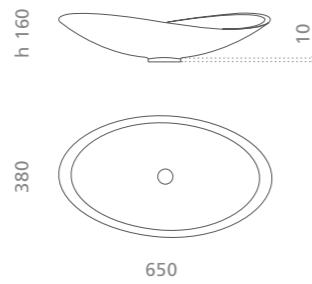

Ø foro / hole = 45 mm
peso / weight = 3,30 kg

code:



code:

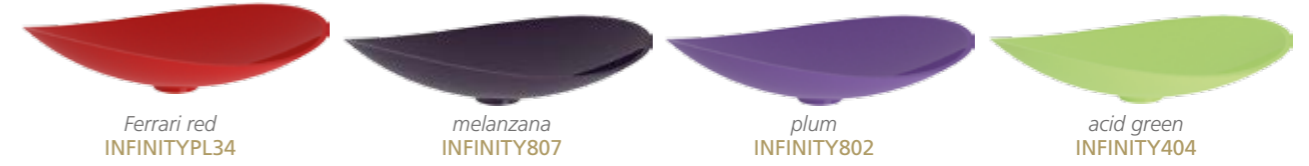

Infinity starlight

Pert®

design by:
MOGIODESIGN

brevettato / patented

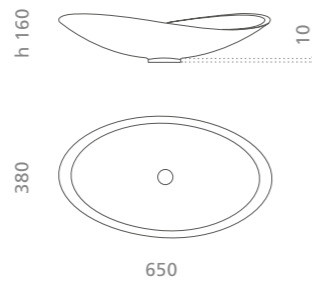

Ø foro / hole = 45 mm
peso / weight = 3,30 kg

code:



code:



Open

Pert®

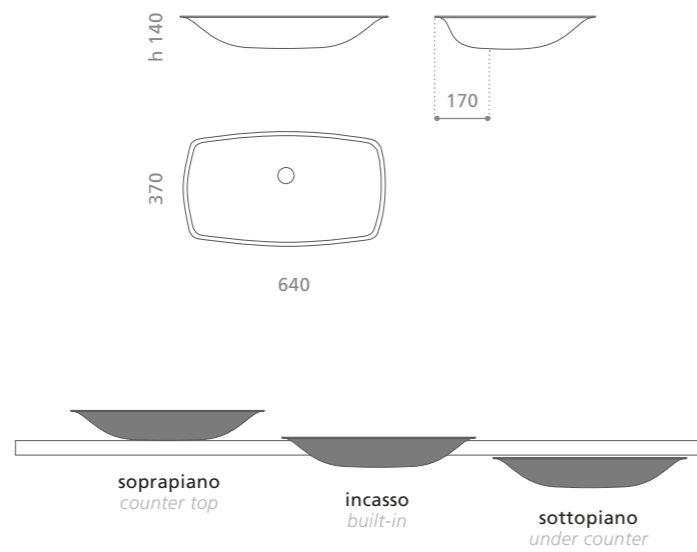

Ø foro / hole = 45 mm
peso / weight = 3,50 kg

code:



code:



code:

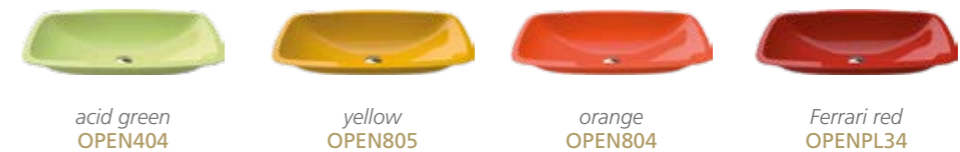

code:



“L'espressione dell'Art-Tech”
“The expression of Art-Tech”

L'hi-tech, elegante e contemporaneo.
Distinguishing with contemporary elegance.



**Exté
Lux
Alumix**

brevettato / patented

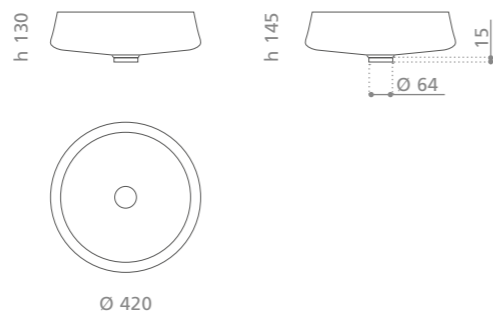

Ø foro / hole = 45 mm
peso / weight = 3,20 kg

code:



white / gold leaf 3d
ALUEXTELWG



white / silver leaf 3d
ALUEXTELWS



black / gold leaf 3d
ALUEXTELBG



black / silver leaf 3d
ALUEXTELBS



**Exté
Lux
Alumix**

brevettato / patented

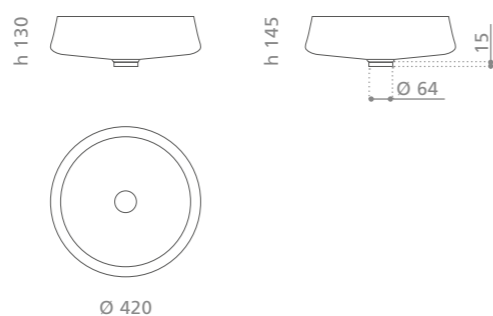

Ø foro / hole = 45 mm
peso / weight = 3,20 kg

code:



white / silver
ALUEXTETA05



black / silver
ALUEXTETA02



brown / black
ALUEXTETA03



**Nek
Lux
Alumix**

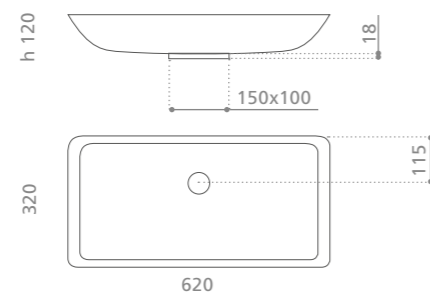

Ø foro / hole = 45 mm
peso / weight = 4,10 kg

code:



white / gold leaf 3d
ALUNEKLWG



white / silver leaf 3d
ALUNEKLWS



black / gold leaf 3d
ALUNEKLBG



black / silver leaf 3d
ALUNEKLBS



**Nek
Alumix**

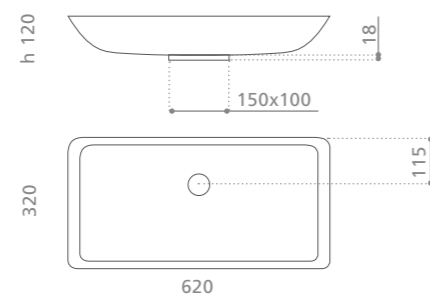

Ø foro / hole = 45 mm
peso / weight = 4,10 kg

code:



white / silver
ALUNEKTA05



black / silver
ALUNEKTA02



brown / black
ALUNEKTA03



**Ares
Alumix**

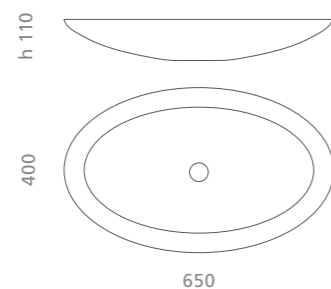

Ø foro / hole = 45 mm
peso / weight = 7,20 kg

code:



white / black
ALUARESA07



black / silver
ALUARESA02



white / copper
ALUARESA08



Round

Alumix

brevettato / patented

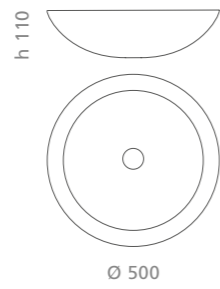

Ø foro / hole = 45 mm
peso / weight = 4,60 kg

code:



white / silver
ALUROA05



black / silver
ALUROA02



red / black
ALUROA04



brown / black
ALUROA03



silver leaf 3D
ALUROFA



gold leaf 3D
ALUROFO



copper leaf 3D
ALUROFR

code:



Vogue

Alumix

brevettato / patented

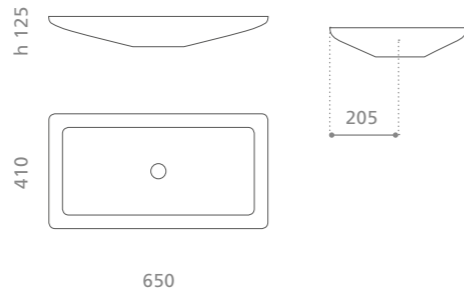

Ø foro / hole = 45 mm
peso / weight = 7,70 kg

code:



white / silver
ALUVOA05



black / silver
ALUVOA02



brown / black
ALUVOA03



silver leaf 3D
ALUVOFA



gold leaf 3D
ALUVOFO



copper leaf 3D
ALUVOFR

code:



Norite

Alumix

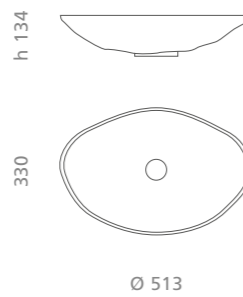

Ø foro / hole = 45 mm
peso / weight = 3,11 kg

code:



silver
NORITESL



gold
NORITEGD



copper
NORITECP

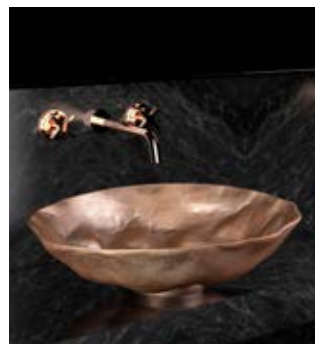

Reverse

Alumix

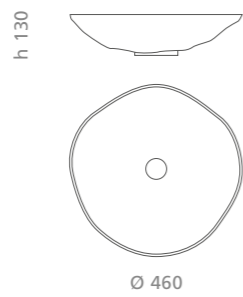

Ø foro / hole = 45 mm
peso / weight = 3,56 kg

code:



silver
REVERSESL



gold
REVERSEGD



copper
REVERSECP



Oxidren

Alumix

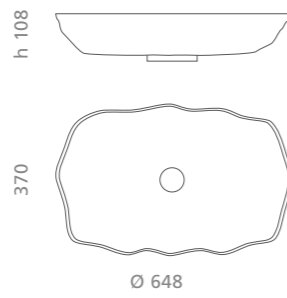

Ø foro / hole = 45 mm
peso / weight = 4,54 kg

code:



silver
OXIDRENSL



gold
OXIDRENGD



copper
OXIDRENCP

“Collezioni esclusive
dal mondo della moda”
L'ultima tendenza di oggetti decorati a mano.

“Exclusive collection inspired
by the fashion world”
Avant-garde trends in artisan product design.



Metropole
Katino

Florence Glass
ATELIER

brevettato / patented

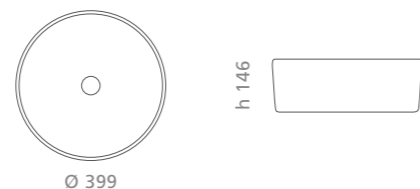

Ø foro / hole = 45 mm
peso / weight = 4,20 kg



code: *white* KATINOMWT *silver* KATINOMSL *gold* KATINOMGD *rose* KATINOMPG *platinum* KATINOMPL

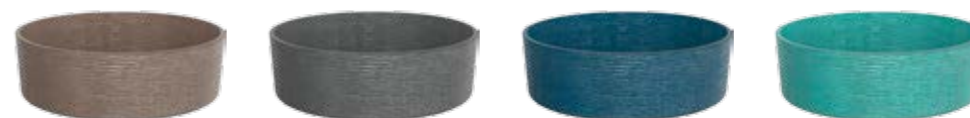

code: *bronze* KATINOMBZ *anthracite* KATINOMAT *blue* KATINOMBL *aquamarine* KATINOMTF



Metropole
Flou

Florence Glass
ATELIER

brevettato / patented

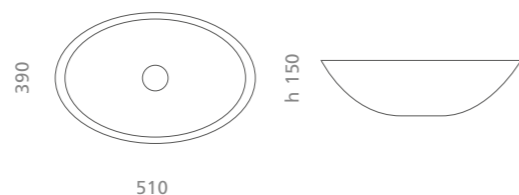

Ø foro / hole = 45 mm
peso / weight = 4,50 kg



code: *white* FLOUMWT *silver* FLOUMSL *gold* FLOUMGD *rose* FLOUMPG *platinum* FLOUMPL



code: *bronze* FLOUMBZ *anthracite* FLOUMAT *blue* FLOUMBL *aquamarine* FLOUMTF



Metropole Round 34

Florence Glass
ATELIER

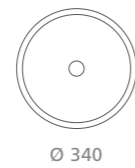

h 125



brevettato / patented

Ø foro / hole = 45 mm
peso / weight = 3,10 kg

code:



white
METROPOLE34WT



silver
METROPOLE34SL



gold
METROPOLE34GD



rose
METROPOLE34PG



platinum
METROPOLE34PL

code:



bronze
METROPOLE34BZ



anthracite
METROPOLE34AT



blue
METROPOLE34BL



aquamarine
METROPOLE34TF



Metropole Round 40

Florence Glass
ATELIER

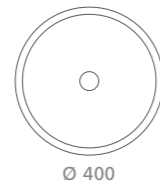

h 150



brevettato / patented

Ø foro / hole = 45 mm
peso / weight = 4,30 kg

code:



white
METROPOLE40WT



silver
METROPOLE40SL



gold
METROPOLE40GD



rose
METROPOLE40PG



platinum
METROPOLE40PL

code:



bronze
METROPOLE40BZ



anthracite
METROPOLE40AT



blue
METROPOLE40BL



aquamarine
METROPOLE40TF



Metropole Round 44

Florence Glass
ATELIER

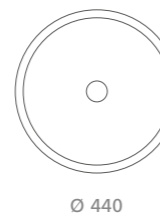

h 150



brevettato / patented

Ø foro / hole = 45 mm
peso / weight = 5,20 kg

code:



white
METROPOLE44WT



silver
METROPOLE44SL



gold
METROPOLE44GD



rose
METROPOLE44PG



platinum
METROPOLE44PL

code:



bronze
METROPOLE44BZ



anthracite
METROPOLE44AT



blue
METROPOLE44BL



aquamarine
METROPOLE44TF





Tekno Materic 40

Florence Glass ATELIER

brevettato / patented

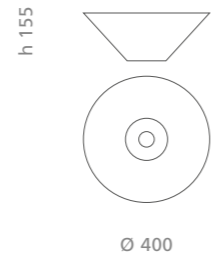

Ø foro / hole = 45 mm
peso / weight = 3,40 kg

code:



clear
TEKNO40T01



white mat
TEKNO40BO



black mat
TEKNO40NO



beige mat
TEKNO40BGO



Tekno Metal 40

Florence Glass ATELIER

brevettato / patented

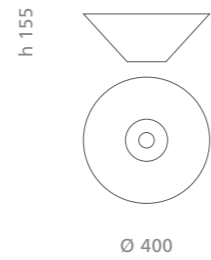

Ø foro / hole = 45 mm
peso / weight = 3,40 kg

code:



iron
TEKNO40IR



platinum
TEKNO40PL



copper
TEKNO40CP



bronze
TEKNO40BZ



Tekno Lux 40

Florence Glass ATELIER

brevettato / patented

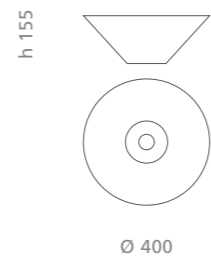

Ø foro / hole = 45 mm
peso / weight = 3,40 kg

code:



silver
TEKNOL40SL



platinum
TEKNOL40PL



rose gold
TEKNOL40PG



gold
TEKNOL40GD



Graffiti 34

Florence Glass
ATELIER



h 125



Ø foro / hole = 45 mm
peso / weight = 3,10 kg

code:



red - gold - ivory
GRAFFITI34RO



black - gold - ivory
GRAFFITI34BG

Graffiti 40

Florence Glass
ATELIER

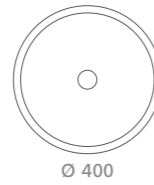

h 150



Ø foro / hole = 45 mm
peso / weight = 4,30 kg

code:



red - gold - ivory
GRAFFITI40RO



black - gold - ivory
GRAFFITI40BG

Graffiti 44

Florence Glass
ATELIER

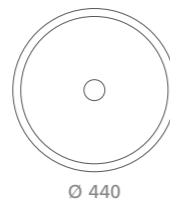

h 150



Ø foro / hole = 45 mm
peso / weight = 5,20 kg

code:



red - gold - ivory
GRAFFITI44RO



black - gold - ivory
GRAFFITI44BG

Venice 40

Florence Glass
ATELIER

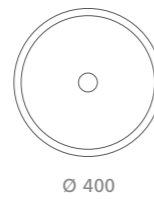

h 150



Ø foro / hole = 45 mm
peso / weight = 4,30 kg

code:



gold / silver
VENICE40OA



silver / black
VENICE40AN



brown / ivory
VENICE40MA

Venice 44

Florence Glass
ATELIER

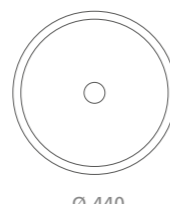

h 150



Ø foro / hole = 45 mm
peso / weight = 5,20 kg

code:



gold / silver
VENICE44OA



silver / black
VENICE44AN



brown / ivory
VENICE44MA



I colori rappresentati in stampa si intendono puramente indicativi. - Print colors of the wash basins may vary slightly from original color.



Mosaic Anniversary

Florence Glass
ATELIER

brevettato / patented

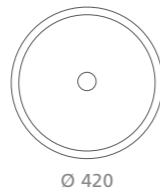

Ø 420



h 145

Ø foro / hole = 45 mm
peso / weight = 4,30 kg

code:



white gloss
MOSAICTBL



black gloss
MOSAICTNL



silver
MOSAICTSL



gold
MOSAICTGD



platinum
MOSAICTPL



rose gold
MOSAICTPG



copper
MOSAICTCP



black metal
MOSAICTBK



Mosaic Anniversary sotto

Florence Glass
ATELIER

brevettato / patented



Ø 420



h 145

Ø foro / hole = 45 mm
peso / weight = 4,30 kg

code:



white gloss
MOSAICTSBL



black gloss
MOSAICTSNL



silver
MOSAICTSSL



gold
MOSAICTSGD



platinum
MOSAICTSPL



rose gold
MOSAICTSPG



copper
MOSAICTSCP



black metal
MOSAICTSBK



Luna 40

Florence Glass
ATELIER

brevettato / patented

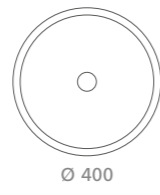

Ø 400



h 150

Ø foro / hole = 45 mm
peso / weight = 4,50 kg

code:



white
LUNA40WT



grey
LUNA40GR



sand
LUNA40SN



yellow
LUNA40YL

Luna 44

Florence Glass
ATELIER

brevettato / patented

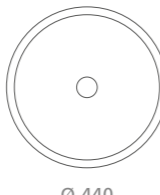

Ø 440



h 150

Ø foro / hole = 45 mm
peso / weight = 5,60 kg

code:



white
LUNA44WT



grey
LUNA44GR



sand
LUNA44SN



yellow
LUNA44YL

Luna 45

Florence Glass
ATELIER

brevettato / patented

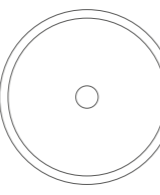

Ø 450



h 170

Ø foro / hole = 45 mm
peso / weight = 6,60 kg

code:



white
LUNA45WT



grey
LUNA45GR



sand
LUNA45SN



yellow
LUNA45YL



I colori rappresentati in stampa si intendono puramente indicativi. - Print colors of the wash basins may vary slightly from original color.



Luna Oval

Florence Glass
ATELIER

brevettato / patented

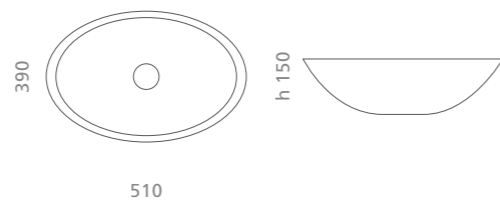

Ø foro / hole = 45 mm
peso / weight = 4,50 kg

code:



white
LUNAOVWT



grey
LUNAOVGR



sand
LUNAOVSN



yellow
LUNAOVYL



Luna Katino

Florence Glass
ATELIER

brevettato / patented

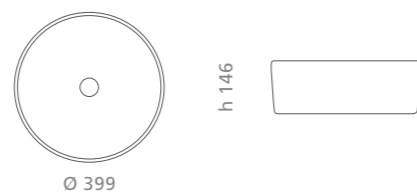

Ø foro / hole = 45 mm
peso / weight = 4,2 kg

code:



white
KATINOLWT



grey
KATINOLGR



sand
KATINOLSN



yellow
KATINOLYL



Gala 40

Florence Glass
ATELIER

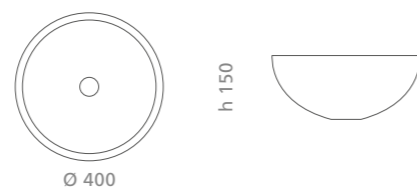

Ø foro / hole = 45 mm
peso / weight = 4,30 kg

code:



silver leaf 3d
GALA40FA



gold leaf 3d
GALA40FO



copper leaf 3d
GALA40FR



Gala 44

Florence Glass
ATELIER

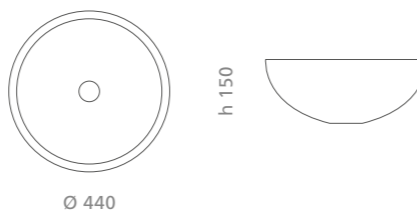

Ø foro / hole = 45 mm
peso / weight = 5,20 kg

code:



silver leaf 3d
GALA44FA



gold leaf 3d
GALA44FO



copper leaf 3d
GALA44FR



Kalahari 30

Florence Glass
ATELIER

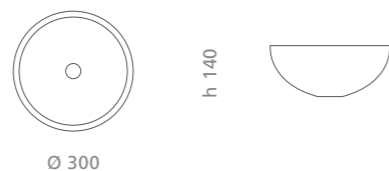

Ø foro / hole = 45 mm
peso / weight = 2,68 kg

code:



white / gold
KALAHARI30WG



black / silver
KALAHARI30BS



Kalahari 40

Florence Glass
ATELIER

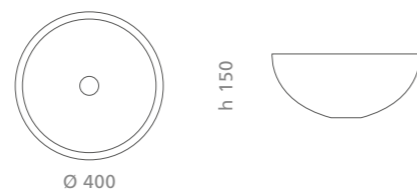

Ø foro / hole = 45 mm
peso / weight = 4,30 kg

code:



white / gold
KALAHARI40WG



black / silver
KALAHARI40BS



Kalahari 44

Florence Glass
ATELIER

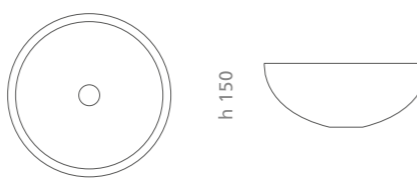

Ø foro / hole = 45 mm
peso / weight = 5,20 kg

code:



white / gold
KALAHARI44WG

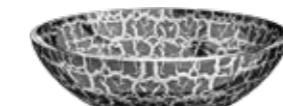

black / silver
KALAHARI44BS



Xeni

Florence Glass
ATELIER

brevettato / patented

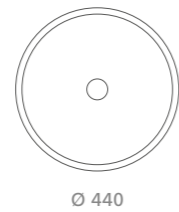

Ø 440

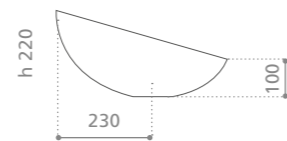

h 220

230

100

Ø foro / hole = 45 mm
peso / weight = 5,20 kg

code:



white
XENIT01WHITE



black
XENIT30BLACK



Flare 34

Florence Glass
ATELIER

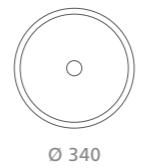

Ø 340



h 125

Ø foro / hole = 45 mm
peso / weight = 3,10 kg

code:



mat
FLARE34S01



white / gold leaf 3d
FLARE34WG



black / silver leaf 3d
FLARE34BS



Flare 40

Florence Glass
ATELIER

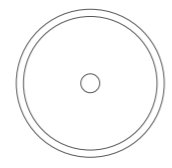

Ø 400



h 150

Ø foro / hole = 45 mm
peso / weight = 4,30 kg

code:



mat
FLARE40S01



white / gold leaf 3d
FLARE40WG



black / silver leaf 3d
FLARE40BS



Flare 44

Florence Glass
ATELIER

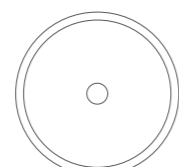

Ø 440



h 150

Ø foro / hole = 45 mm
peso / weight = 5,20 kg

code:



mat
FLARE44S01



white / gold leaf 3d
FLARE44WG

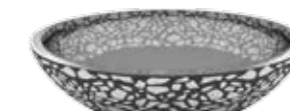

black / silver leaf 3d
FLARE44BS



Filigrana 34

Florence Glass
ATELIER

brevettato / patented

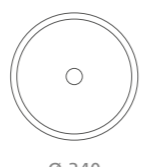

Ø 340



h 125

Ø foro / hole = 45 mm
peso / weight = 3,10 kg

code:



white / gold leaf 3d
FILIGRANA34WG



gold leaf 3d / white
FILIGRANA34FOW



black / silver leaf 3d
FILIGRANA34BS



silver leaf 3d / black
FILIGRANA34FAB



Filigrana 40

Florence Glass
ATELIER

brevettato / patented

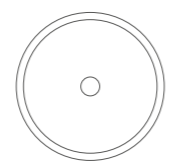

Ø 400



h 150

Ø foro / hole = 45 mm
peso / weight = 4,30 kg

code:



white / gold leaf 3d
FILIGRANA40WG



gold leaf 3d / white
FILIGRANA40FOW



black / silver leaf 3d
FILIGRANA40BS



silver leaf 3d / black
FILIGRANA40FAB



Filigrana 44

Florence Glass
ATELIER

brevettato / patented

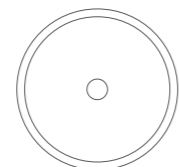

Ø 440

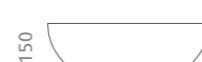

h 150

Ø foro / hole = 45 mm
peso / weight = 5,20 kg

code:



white / gold leaf 3d
FILIGRANA44WG



gold leaf 3d / white
FILIGRANA44FOW



black / silver leaf 3d
FILIGRANA44BS



silver leaf 3d / black
FILIGRANA44FAB



I colori rappresentati in stampa si intendono puramente indicativi. - Print colors of the wash basins may vary slightly from original color.



Flare tech 40

Florence Glass ATELIER

brevettato / patented

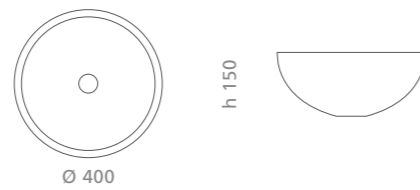

Ø foro / hole = 45 mm
peso / weight = 4,30 kg

code:



white / gold leaf 3d
FLARET40WG



black / silver leaf 3d
FLARET40BS

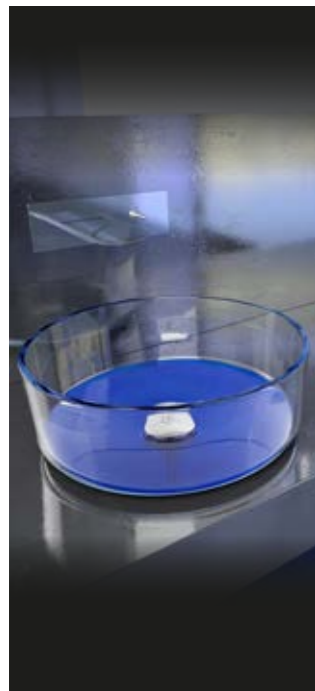

Drop Katino

Florence Glass ATELIER

brevettato / patented

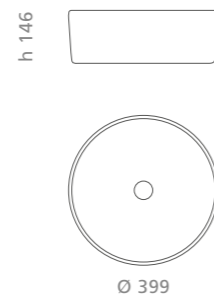

Ø foro / hole = 45 mm
peso / weight = 4,20 kg

code:



blue
DROPK39T18



marine
DROPK39T20



turquoise
DROPK39T12



green
DROPK39T23



red
DROPK39T16



yellow
DROPK39T37



Flou

Florence Glass ATELIER

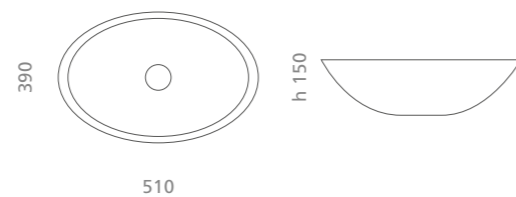

Ø foro / hole = 45 mm
peso / weight = 4,50 kg

code:



clear
FLOUT01



white / gold
FLOUWG



black / gold
FLOUBG



gold leaf 3d
FLOUFO



black / silver
FLOUBS



silver leaf 3d
FLOUFA



Soffio

Florence Glass ATELIER

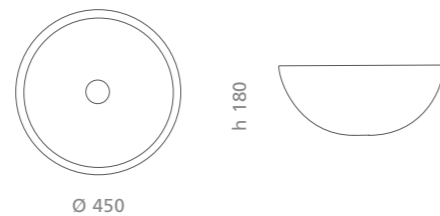

Ø foro / hole = 45 mm
peso / weight = 6,00 kg

code:



clear
SOFFIOT01



white / gold
SOFFIOWG



black / gold
SOFFIOBG



gold leaf 3d
SOFFIOFO



black / silver
SOFFIOBS



silver leaf 3d
SOFFIOFA





Globo

Florence Glass
ATELIER

brevettato / patented



Ø foro / hole = 45 mm
peso / weight = 3,65 kg



code: clear
GLOBO34T01



code: white mat
GLOBO34BO



code: black mat
GLOBO34NO



code: beige mat
GLOBO34BGO



Bamboo Katino

Florence Glass
ATELIER

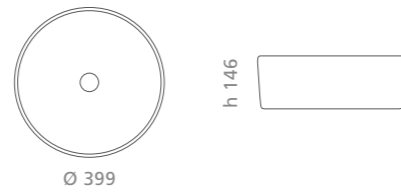

Ø foro / hole = 45 mm
peso / weight = 4,20 kg



code: black
BAMBOOK39NO



code: grey
BAMBOOK39GR



code: copper
BAMBOOK39CP



Mistral Lux

Florence Glass
ATELIER

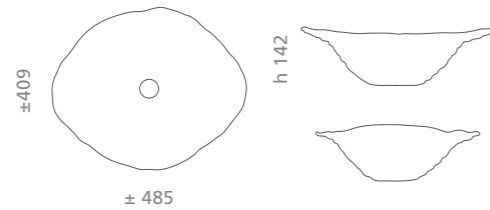

Ø foro / hole = 45 mm
peso / weight = 2,91 kg



code: silver / chrome
MISTRALLSLF4



code: gold / chrome
MISTRALLGDF4



code: rose gold / chrome
MISTRALLPGF4



code: platinum / chrome
MISTRALLPLF4

Speciale piletta cromata inclusa / Special chrome waste included



City Lux

Florence Glass
ATELIER

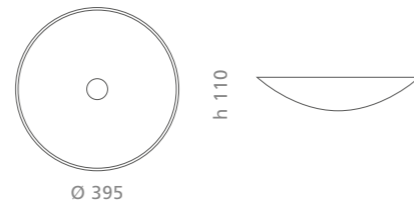

Ø foro / hole = 45 mm
peso / weight
lavabo / wash basin = 2,10 kg
piletta ABS / waste = 0,35 kg
anello / ring basement = 0,42 kg



code: silver / chrome
CITY40LSLF4



code: gold / chrome
CITY40LGDF4



code: rose gold / chrome
CITY40LPGF4



code: platinum / chrome
CITY40LPLF4

Piletta in ABS ed anello cromato inclusi / Chrome ABS waste and ring basement included



Arabesque Lux

Florence Glass
ATELIER

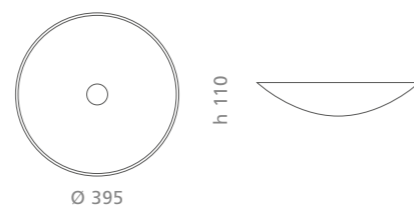

Ø foro / hole = 45 mm
peso / weight
lavabo / wash basin = 1,73 kg
piletta ABS / waste = 0,35 kg
anello / ring basement = 0,42 kg



code: silver / chrome
ARABESQUELSLF4



code: gold / chrome
ARABESQUELGDF4



code: rose gold / chrome
ARABESQUELPGF4



code: platinum / chrome
ARABESQUELPLF4

Piletta in ABS ed anello cromato inclusi / Chrome ABS waste and ring basement included



INOX ZERO®

“Inox 3D” “Inox 3D”

L'evoluzione dell'inox.
Inox evolution.



Mito
INOX ZERO®

brevettato / patented

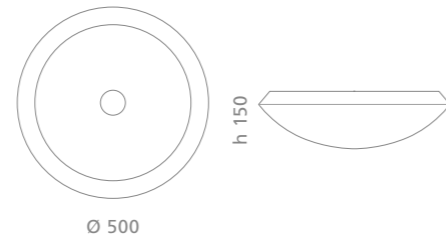

Ø foro / hole = 45 mm
peso / weight = 2,17 kg

code:



shiny inox
MITOIL01



white gloss
MITOBL



black mat
MITONO



Glo Ball
INOX ZERO®

brevettato / patented

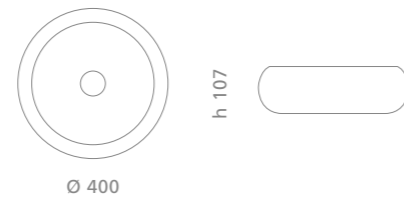

Ø foro / hole = 45 mm
peso / weight = 1,90 kg

code:



shiny inox
GLOBALLI01



white gloss
GLOBALLBL



black mat
GLOBALLNO



De Coste
INOX ZERO®

brevettato / patented

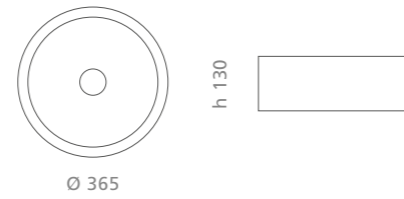

Ø foro / hole = 45 mm
peso / weight = 1,90 kg

code:



brushed inox
DECOSTEIS01



white gloss
DECOSTEBL



black mat
DECOSTENO

Siliconio®

“Touch design per eccellenza” “Excellence you can touch and feel”

Il design tattile, morbido, elastico, sensuale.
Touch and feel - soft and sensual.



Barchetta
Siliconio

brevettato / patented

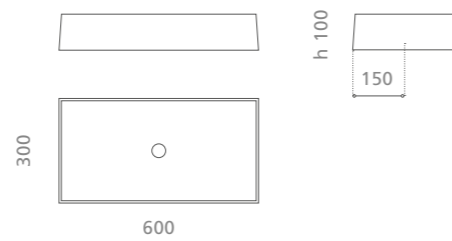

Ø foro / hole = 45 mm
peso / weight = 5,50 kg

code:



green
BARCHSL32



black
BARCHSL30



red
BARCHSL34



blue
BARCHSL02



Barchetta light
Siliconio

brevettato / patented

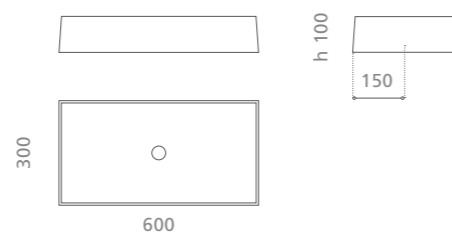

Ø foro / hole = 45 mm
peso / weight = 5,70 kg

code:



red light
BARCHSL34L



blue light
BARCHSL02L

completo di illuminazione led e trasformatore.
Led light and transformer included.



Gum
Siliconio

brevettato / patented

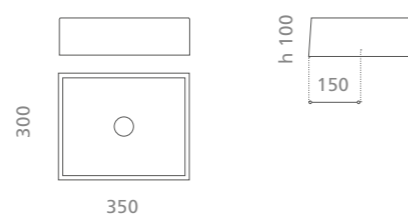

Ø foro / hole = 45 mm
peso / weight = 3,20 kg

code:



white
GUMSL01



yellow
GUMSL05



orange
GUMSL26



red
GUMSL34



blue
GUMSL02



plum
GUMSL82



violet
GUMSL87



alice blue
GUMSL43



black
GUMSL30

“Tradizione senza tempo”
“Timeless tradition”



Mode
Lux



brevettato / patented

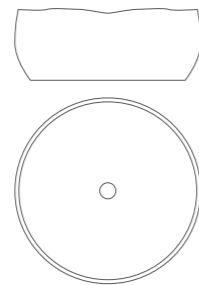

h 162

Ø 405

Ø foro / hole = 45 mm
peso / weight = 7,70 kg

code:



gun metal / gold
MODE40MGD



gun metal / silver
MODE40GMSL



gun metal / bronze
MODE40GMBZ



Mode
Classic



brevettato / patented

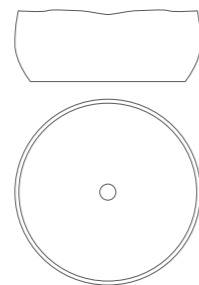

h 162

Ø 405

Ø foro / hole = 45 mm
peso / weight = 7,70 kg

code:



white
MODE40RWT



sand
MODE40RSN



vulcano
MODE40RVL



Polo



brevettato / patented

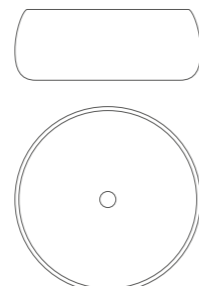

h 151

Ø 410

Ø foro / hole = 45 mm
peso / weight = 7,70 kg

code:



white
POLO41RWT



sand
POLO41RSN



gunmetal
POLO41GM

Realizzato a mano da maestri ceramisti secondo le più rinomate tradizioni.
Eventuali piccole imperfezioni di forma e colore sono testimonianza
dell'artigianalità del processo produttivo.
Handmade by master ceramists according to the most ancient and notable
ceramic arts.
Any slight imperfections and variations in shape and colour highlight the
craftsmanship of the production process.

Dettagli di “valore”

Piletta scarico libero

Piletta in ottone a scarico libero con logo GD
Waste with free flow plug with GD logo
(Ø 70 - H 100 mm)

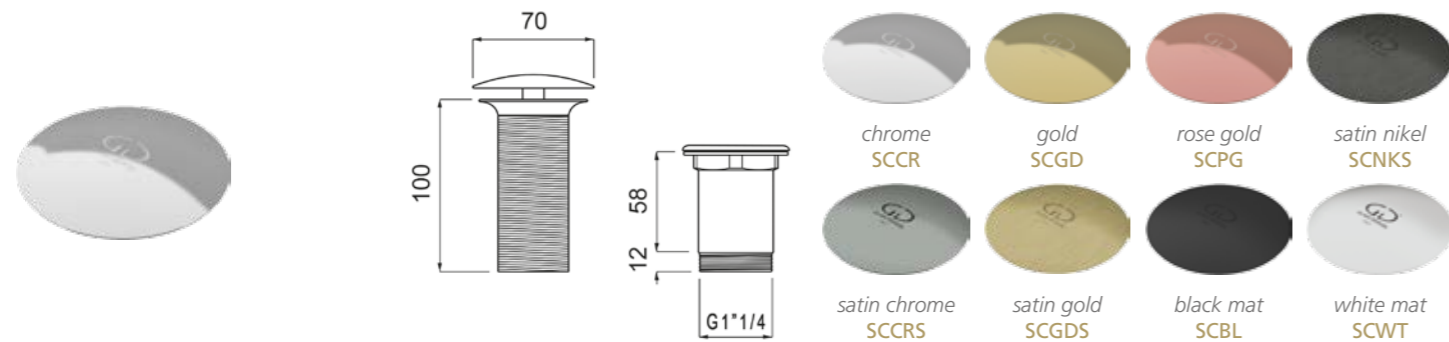

Piletta clik-clak con troppopieno

Piletta clik clak con logo GD (con troppo pieno)
Up & Down waste with GD logo (with overflow)
(Ø 63,5 - H 100 mm)

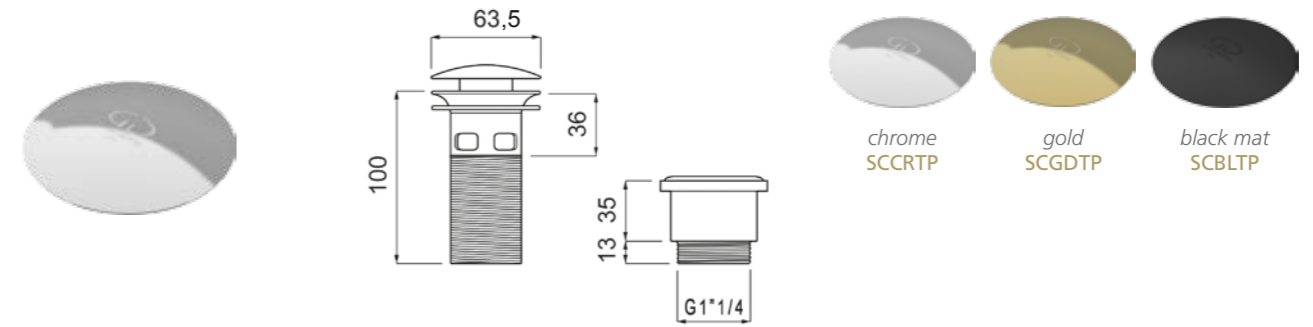

Piletta ABS clik-clak con o senza troppopieno

Piletta ABS clik clak con logo GD utilizzabile per lavabi senza e con troppo pieno
Up & Down ABS waste with GD logo suitable for washbasins with and without overflow
(Ø 72 - H 100 mm)

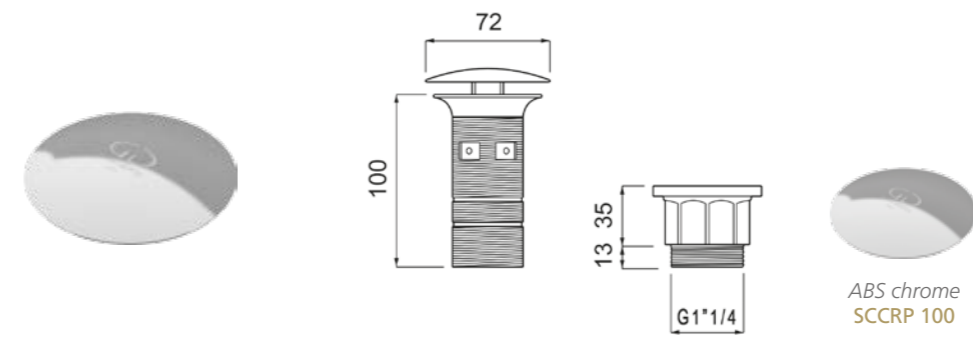

Piletta ABS scarico libero

Piletta ABS a scarico libero con logo GD
ABS waste with free flow plug with GD logo
(Ø 72 - H 100 mm)

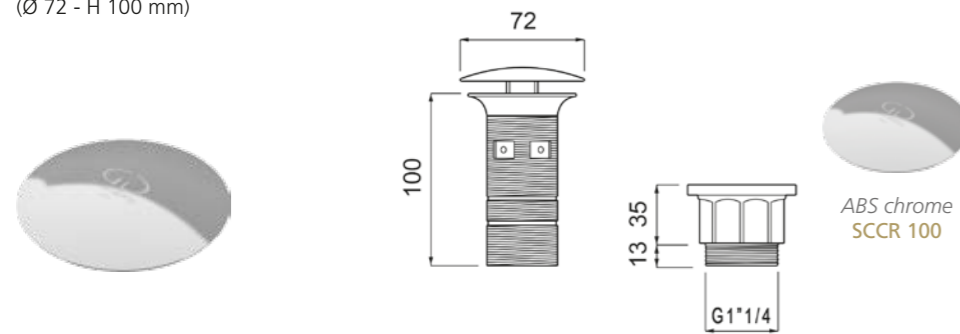

Piletta clik-clak senza troppopieno

Piletta clik clak in ottone con logo GD
Up & Down waste with GD logo (without overflow)
(Ø 63,5 - H 100 mm)

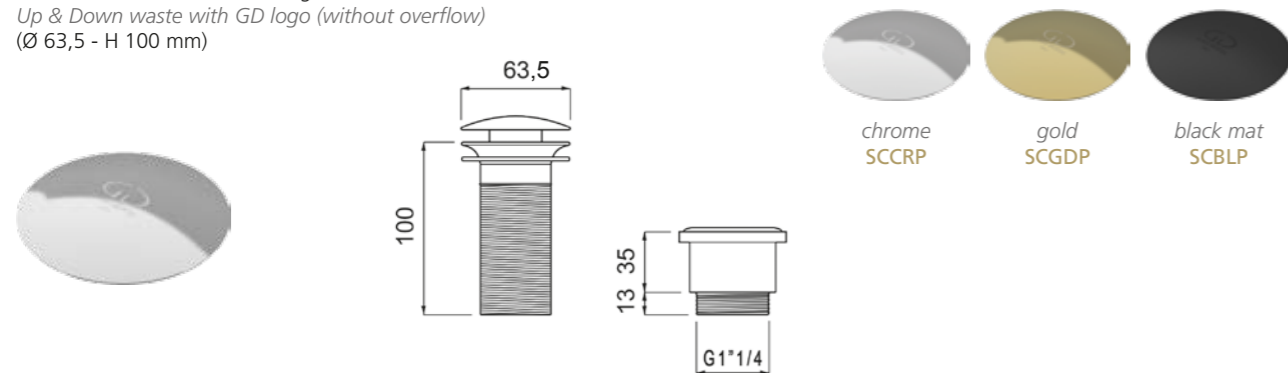

Piletta scarico libero tappo XL

Piletta a scarico libero con logo GD
Waste with free flow plug with GD logo
(Ø 105 - H 100 mm)

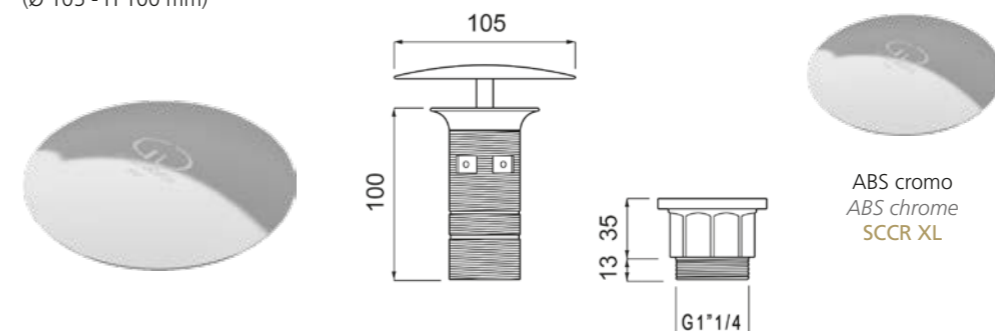

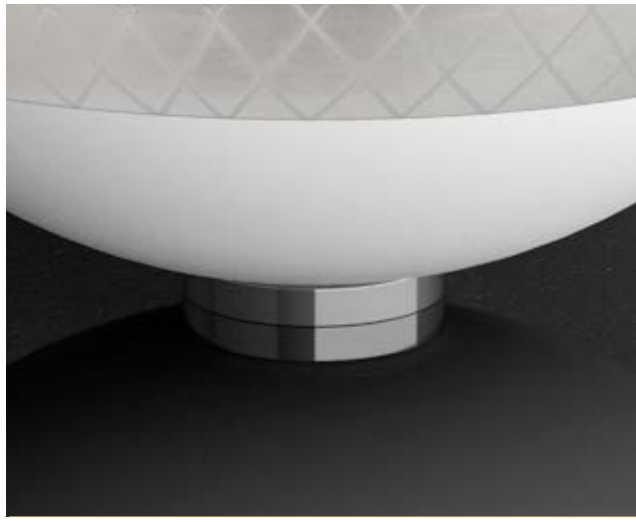

Base anello Ring basement

Anello Standard con o'ring

Base anello in ottone con o'ring in silicone per lavabo da appoggio
Brass ring basement with silicon o'ring for counter top washbasin



Anello per Flou con o'ring

Base anello in ottone con doppio o'ring in silicone e guarnizione per lavabo FLOU da appoggio
Brass ring basement with double silicon o'ring and gasket for FLOU counter top washbasin



Anello per Katino con o'ring

Base anello in ottone con doppio o'ring in silicone e guarnizione per lavabo KATINO da appoggio
Brass ring basement with double silicon o'ring and gasket for KATINO counter top washbasin



Tondo Sifone tondo Round siphon

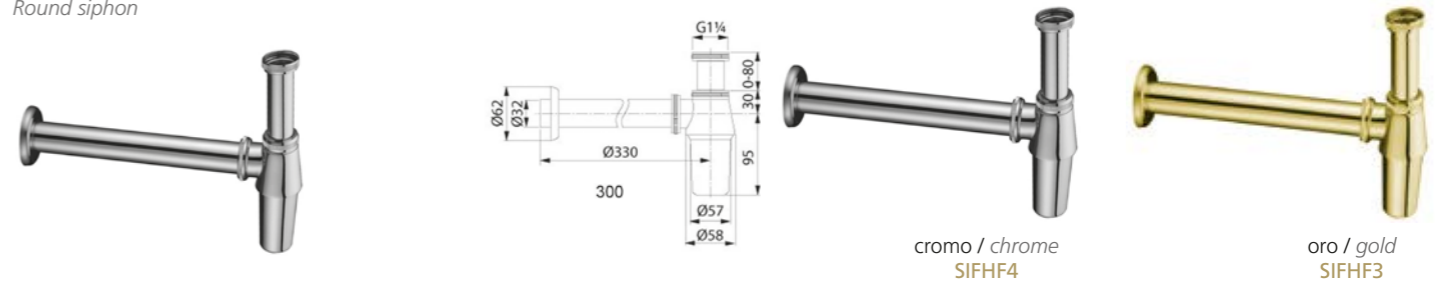

Quadro Sifone quadrato Square siphon

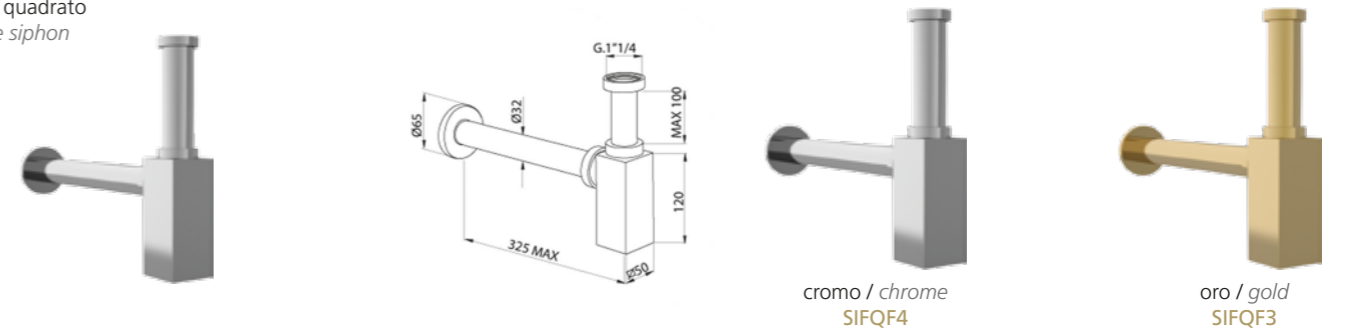

Troppo pieno

Troppo pieno completo per scarico lavabo 1" 1/4
Overflow joint for basin waste 1" 1/4

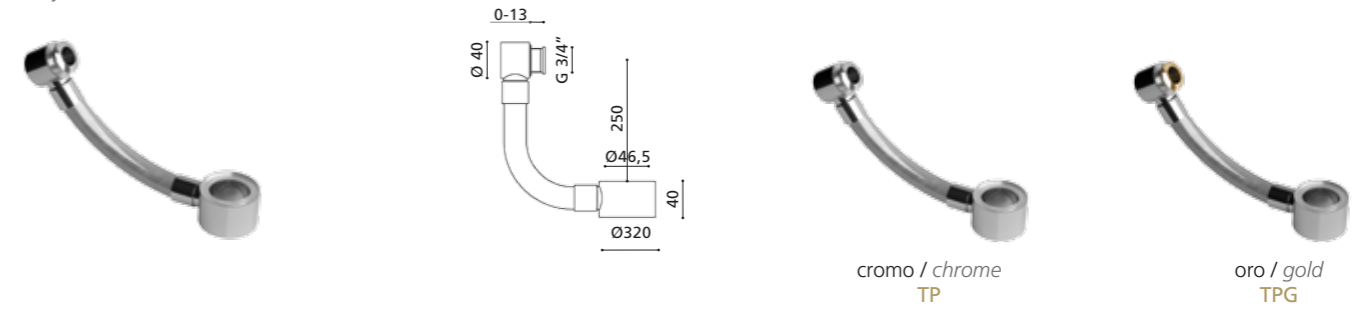

Troppo pieno ABS

Troppo pieno per lavabi sottopiano ABS bianco (con anello cromato)
White ABS basin overflow (with chrome ring) for under mounted wash basins

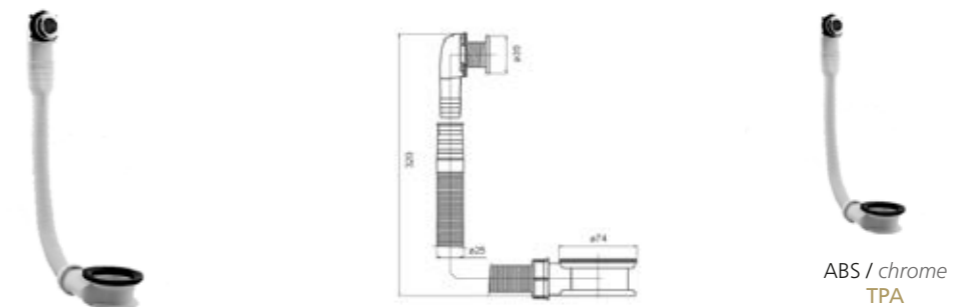



Specchio Tondo

round mirror

MDF wood

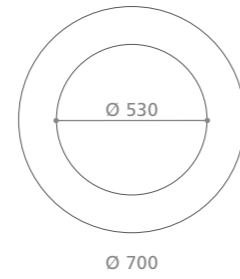

code:

white gloss
FLOMIRROBL



white mat
FLOMIRROBO



black gloss
FLOMIRRONL



black mat
FLOMIRRONO



Ferrari red
FLOMIRROPL34



code:

gold leaf 3d
FLOMIRROFO



silver leaf 3d
FLOMIRROFA



gold mat
FLOMIRROGD



dark inox mat
FLOMIRRODI



Specchio Ovale

oval mirror

MDF wood

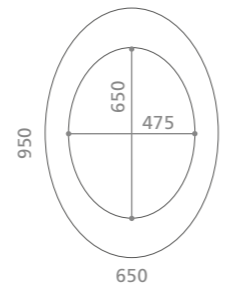

code:

white gloss
FLOMIROVBL



white mat
FLOMIROVBO



black gloss
FLOMIROVNL

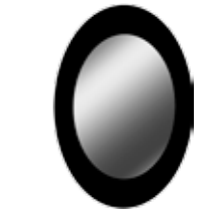

black mat
FLOMIROVNO



Ferrari red
FLOMIROVPL34



code:

gold leaf 3d
FLOMIROVFO



silver leaf 3d
FLOMIROVFA



gold mat
FLOMIROVGD

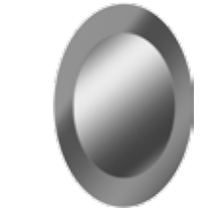

dark inox mat
FLOMIROVDI



Specchio Rettangolare

rectangular mirror

MDF wood

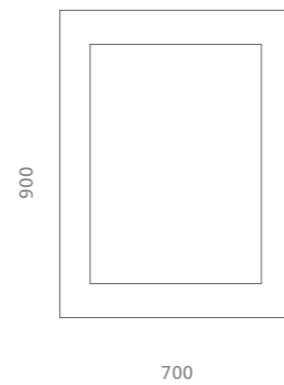

code:

white gloss
MIRRETL



white mat
MIRRETBO



black gloss
MIRRETNL



black mat
MIRRETNO



Ferrari red
MIRRETPL34



code:

gold leaf 3d
MIRRETFO



silver leaf 3d
MIRRETFA



gold mat
MIRRETGD

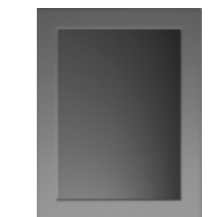

dark inox mat
MIRRETDI



Specchio bj

bj mirror

Alumix

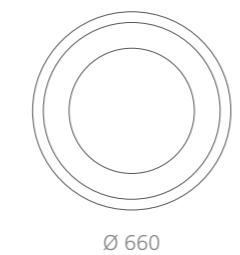

code:

white / silver
ALUBJMIRA05



black / silver
ALUBJMIRA02



gold leaf 3d
ALUBJMIRFO

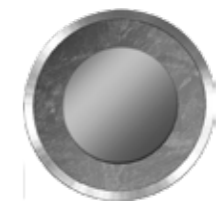

silver leaf 3d
ALUBJMIRFA



copper leaf 3d
ALUBJMIRFR

“Accessori” Accessories



Valentino

Glass

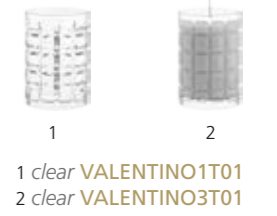
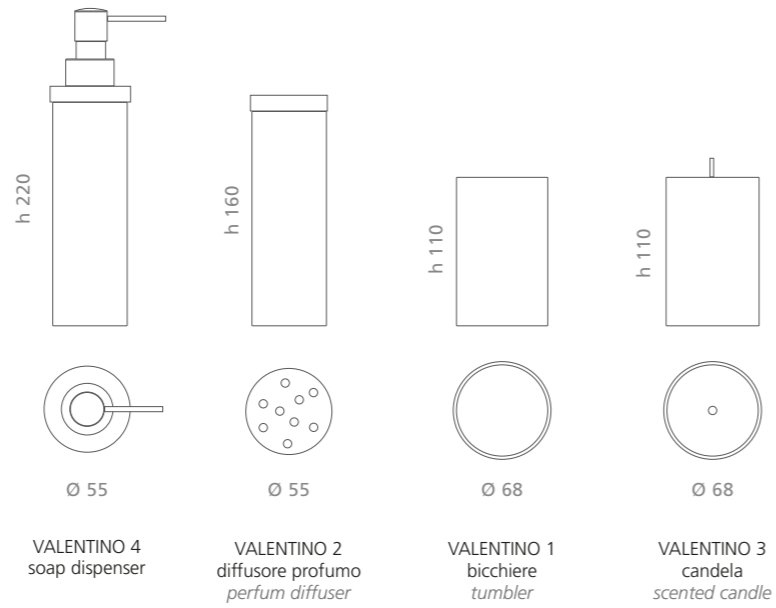

Tonda

Vetro Freddo

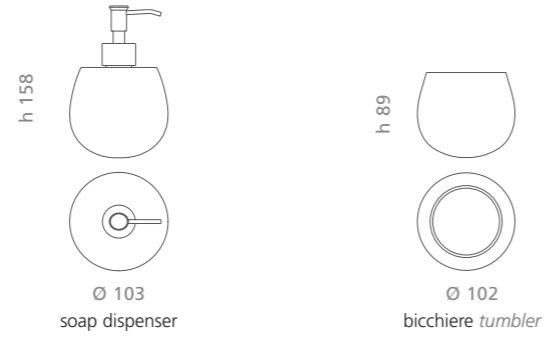

Kleiss

Vetro Freddo

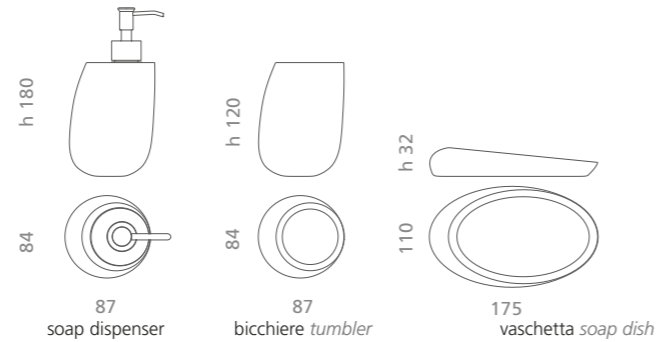

Navy

Vetro Freddo

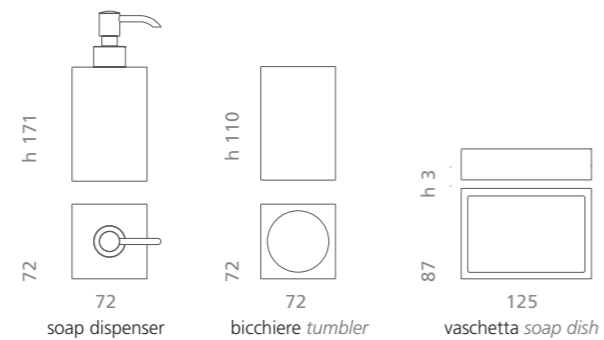



Metropole

Vetro Freddo

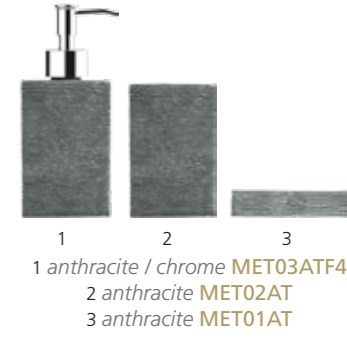
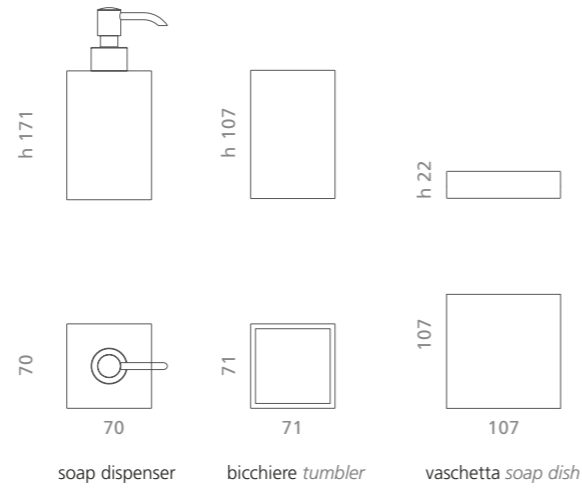

Colori

Glass

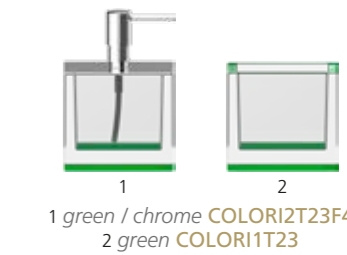
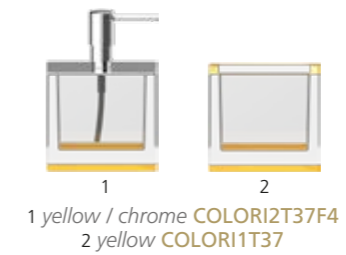
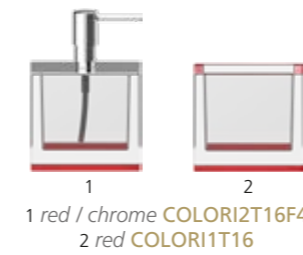
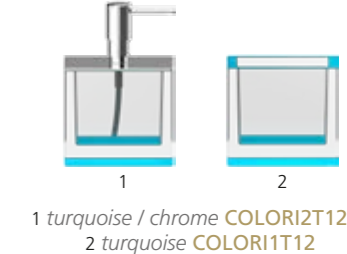
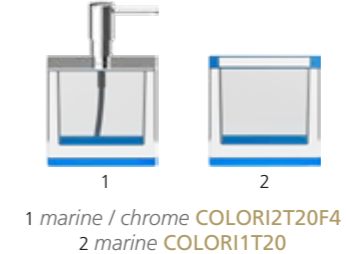
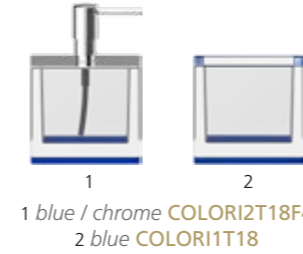
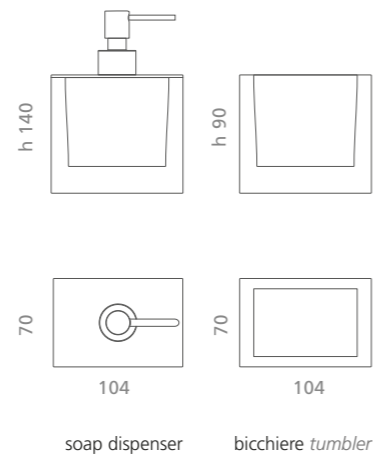

Colori Lux

Glass

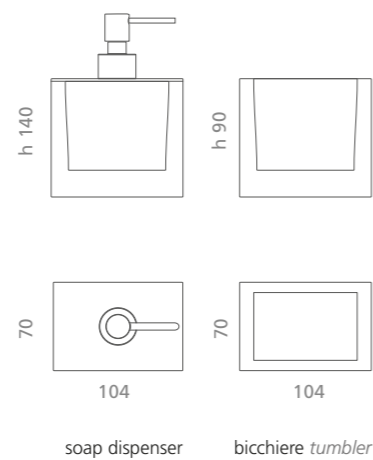



Luxury

Glass

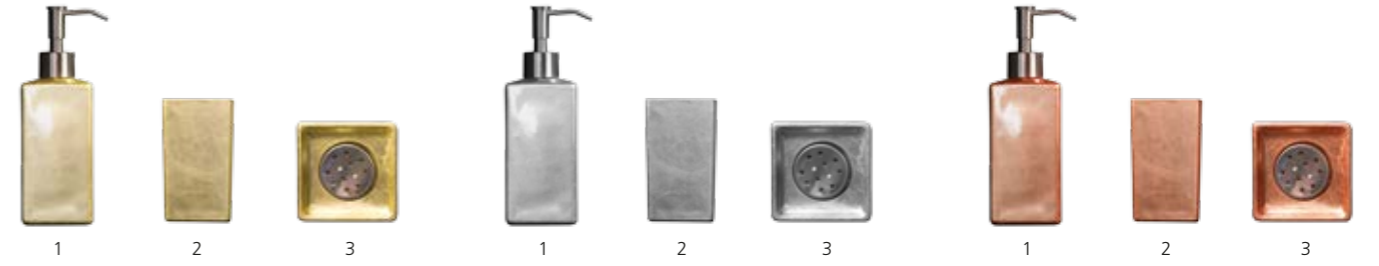
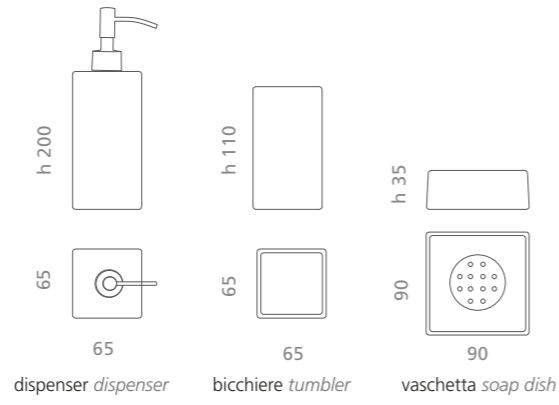

1 gold leaf 3d LUX03FO
2 gold leaf 3D LUX02FO
3 gold leaf 3D LUX01FO

1 silver leaf 3d LUX03FA
2 silver leaf 3d LUX02FA
3 silver leaf 3d LUX01FA

1 copper leaf 3d LUX03FR
2 copper leaf 3d LUX02FR
3 copper leaf 3d LUX01FR



Venice

Glass

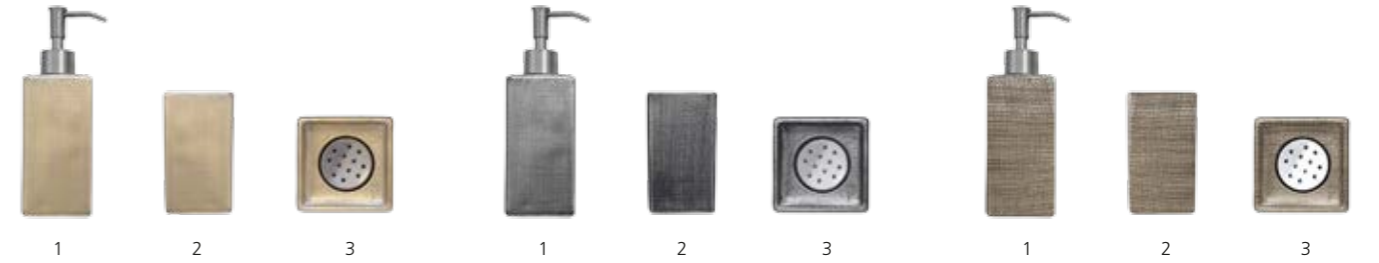
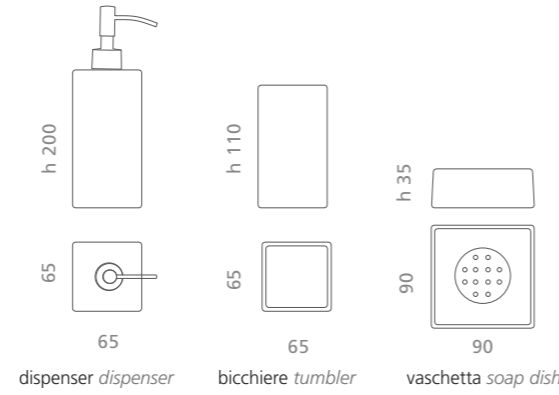

1 gold / silver VEN03OA
2 gold / silver VEN02OA
3 gold / silver VEN01OA

1 black / silver VEN03AN
2 black / silver VEN02AN
3 black / silver VEN01AN

1 brown / black VEN03MA
2 brown / black VEN02MA
3 brown / black VEN01MA



Graffiti

Glass

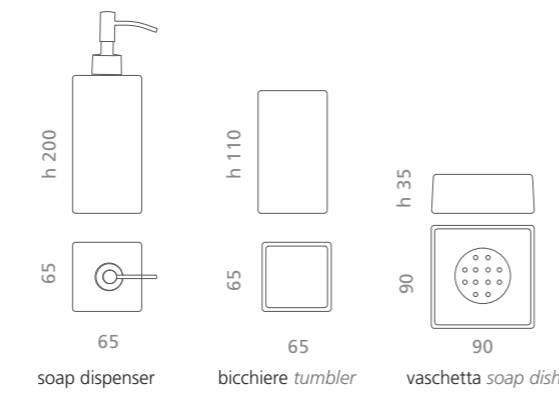

1 red / gold / ivory GRAF03RO
2 red / gold / ivory GRAF02RO
3 red / gold / ivory GRAF01RO

1 black / gold / ivory GRAF03BG
2 black / gold / ivory GRAF02BG
3 black / gold / ivory GRAF01BG



Glamour

Alumix

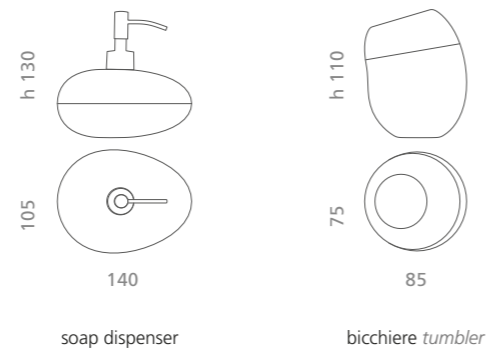

1 brown-black / chrome GLAM03A0F4
2 brown-black GLAM02A03

1 black-silver / chrome GLAM03A03F4
2 black-silver GLAM03A02

1 white-silver / chrome GLAM03A05F4
2 white-silver GLAM02A05



Quadra

Alumix

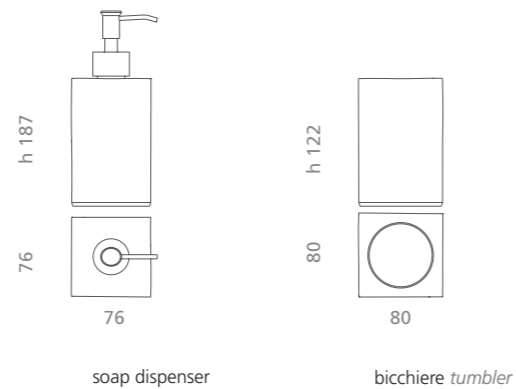

1 brown-black / chrome QUADRA2A03F4
2 brown-black QUADRA1A03

1 black-silver / chrome QUADRA2A02F4
2 black-silver QUADRA1A02

1 white-silver / chrome QUADRA2A05F4
2 white-silver QUADRA1A05

Icessence



Icessence n°1

Soap dispenser

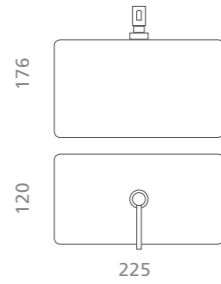

clear / chrome
ICESSENCE1T01F4



clear / gold
ICESSENCE1T01F3

Icessence Luxor



Icessence Luxor n°1

Soap dispenser

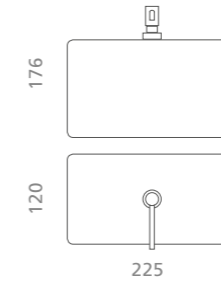

clear / chrome
ICESSENCELUX1T01F4



clear / gold
ICESSENCELUX1T01F3

Icessence n°2

Perfume diffuser

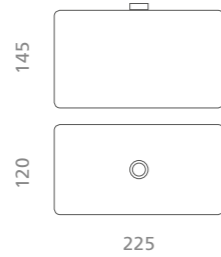

clear / chrome
ICESSENCE2T01F4



clear / gold
ICESSENCE2T01F3

Icessence Luxor n°2

Perfume diffuser

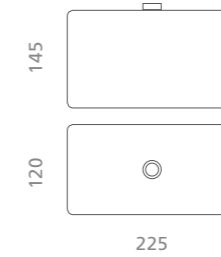

clear / chrome
ICESSENCELUX2T01F4



clear / gold
ICESSENCELUX2T01F3

Icessence Ice



Icessence Ice n°1

Soap dispenser

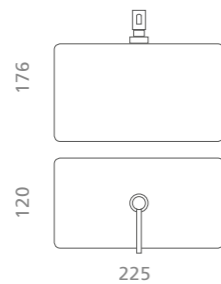

clear / chrome
ICESSENCEICE1T01F4



clear / gold
ICESSENCEICE1T01F3

Icessence Ramada



Icessence Ramada n°1

Soap dispenser

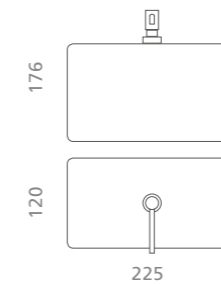

clear / chrome
ICESSENCERAM1T01F4



clear / gold
ICESSENCERAM1T01F3

Icessence Ice n°2

Perfume diffuser

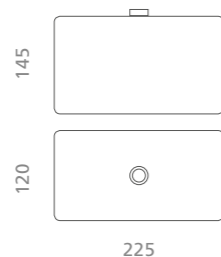

clear / chrome
ICESSENCEICE2T01F4



clear / gold
ICESSENCEICE2T01F3

Icessence Ramada n°2

Perfume diffuser

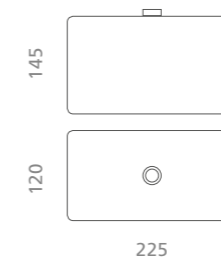

clear / chrome
ICESSENCERAM2T01F4



clear / gold
ICESSENCERAM2T01F3



Drop essence

Blue

Cristallo
DE' MEDICI
Pb 24%



Soap dispenser

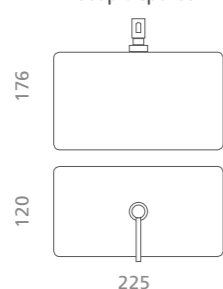

clear-blue / chrome
DROPESENCE1T18F4



Perfume diffuser

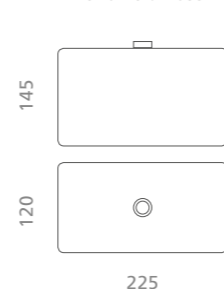

clear-blue / chrome
DROPESENCE2T18F4

Drop essence

Red

Cristallo
DE' MEDICI
Pb 24%



Soap dispenser

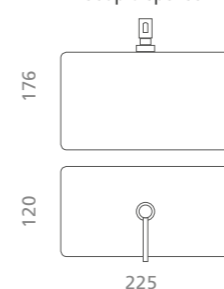

clear-red / chrome
DROPESENCE1T16F4



Perfume diffuser

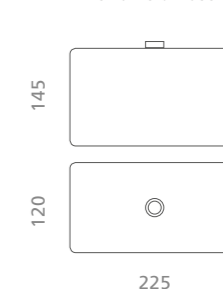

clear-red / chrome
DROPESENCE2T16F4

Drop essence

Marine

Cristallo
DE' MEDICI
Pb 24%



Soap dispenser

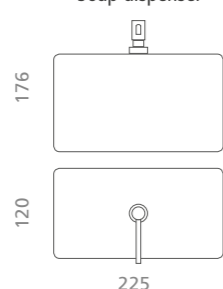

clear-marine / chrome
DROPESENCE1T20F4



Perfume diffuser

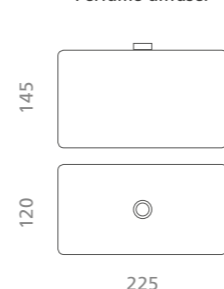

clear-marine / chrome
DROPESENCE2T20F4

Drop essence

Yellow

Cristallo
DE' MEDICI
Pb 24%



Soap dispenser

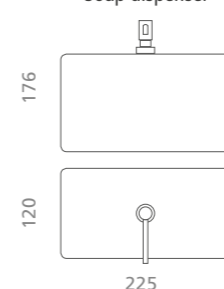

clear-yellow / chrome
DROPESENCE1T37F4



Perfume diffuser

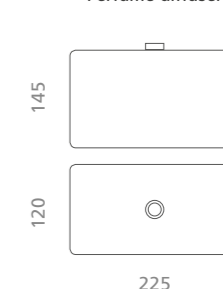

clear-yellow / chrome
DROPESENCE2T37F4

Drop essence

Turquoise

Cristallo
DE' MEDICI
Pb 24%



Soap dispenser

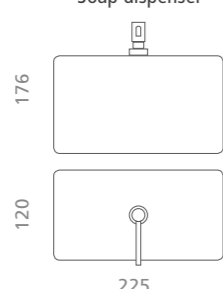

clear-turquoise / chrome
DROPESENCE1T12F4



Perfume diffuser

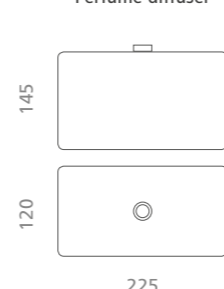

clear-turquoise / chrome
DROPESENCE2T12F4

Drop essence

Green

Cristallo
DE' MEDICI
Pb 24%



Soap dispenser

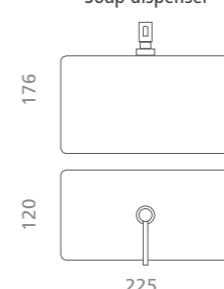

clear-green / chrome
DROPESENCE1T23F4



Perfume diffuser

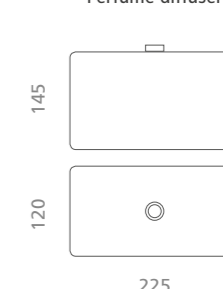

clear-green / chrome
DROPESENCE2T23F4

SPECIAL ONE



Opera
large

Cristallo
DE' MEDICI
Pd 24%

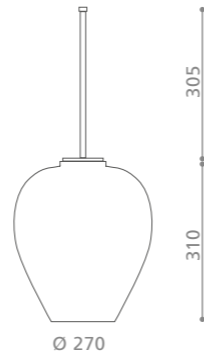

305
310
Ø 270

code:



clear / gold
OPERALT01F3



clear / chrome
OPERALT01F4



Opera
xl

Cristallo
DE' MEDICI
Pd 24%

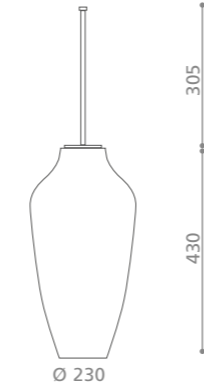

305
430
Ø 230

code:



clear / gold
OPERAXLT01F3



clear / chrome
OPERAXLT01F4



Opera
small

Cristallo
DE' MEDICI
Pd 24%

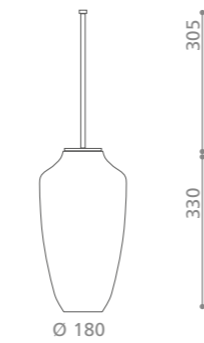

305
330
Ø 180

code:



clear / gold
OPERAST01F3



clear / chrome
OPERAST01F4



Canto
xl

Cristallo
DE' MEDICI
Pd 24%

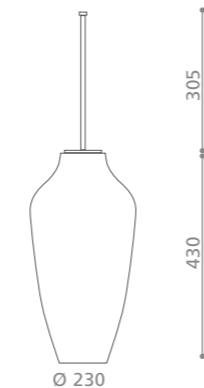

305
430
Ø 230

code:



clear / gold
CANTOXLT01F3



clear / chrome
CANTOXLT01F4



Canto
small

Cristallo
DE' MEDICI
Pd 24%

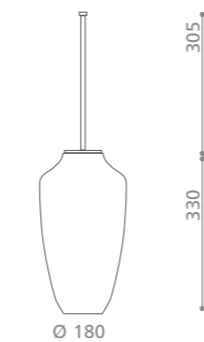

305
330
Ø 180

code:



clear / gold
CANTOST01F3



clear / chrome
CANTOST01F4



brevettato / patented

brevettato / patented



Luxury toilet brush

“Materiali”

Materials

Design senza confini

Design without borders

Collezioni esclusive, realizzate in cristallo purissimo al 24% pb.
Si tratta di prodotti raffinatissimi, soffiati a bocca e molati a pietra con abilità, dai nostri maestri secondo le più antiche e nobili arti vetrarie. Nessuna macchina, nessuna tecnologia, ma solo prodotti d'arte, classici, contemporanei ... futuristici.
Exclusive collections created from pure crystal with 24% lead content.
These utmost refined products are mouth-blown and bevelled in stone by our master artists according to the most ancient and noble glass arts. Neither machines nor technology are employed in the process, resulting in classical, contemporary or futuristic art products.



Il vetro di Murano è da sempre sinonimo di raffinatezza, leggerezza ed eleganza. I maestri vetrai hanno saputo sviluppare tecniche di lavorazioni privilegiate, nel rispetto della millenaria tradizione che rende il vetro di Murano un prodotto unico, prestigioso e inimitabile.
Murano glass is a synonym for elegance and timelessness.
By combining innovative techniques with traditional artisan workmanship, unique, prestigious and inimitable objects are created.



Estratto dalle famose cave di Carrara, il marmo Calacatta è il marmo più prezioso e ricercato al mondo. Michelangelo lo usò per realizzare il suo David, capolavoro della scultura rinascimentale, proprio per la sua particolare bellezza del suo bianco cristallino e delle sue inconfondibili venature sinuose.
Unico tra i marmi, il Calacatta permette di dare libero sfogo al design nella ricerca della sua forma ideale, garantendo lusso estetico unito alle migliori prestazioni di duratura e alle nuove tendenze tecnologiche.
Retrieved from the famous quarries of Carrara, Calacatta is the most valuable and sought after marble in the world. Michelangelo chose it to create David, that masterpiece of Renaissance sculpture, precisely because of the particular beauty presented by its white crystalline structure and distinctive veins. Unique among marbles, Calacatta gives free rein to design in the pursuit of its ideal form, ensuring luxurious aesthetics combined with long-lasting performance and an affinity with the latest technological trends.



Materials
Materials

Vetro Freddo®

Il Vetro Freddo® è un materiale innovativo, composto da pigmenti vetrosi e resine. La sua caratteristica principale è la sua versatilità nell'adattarsi a qualsiasi tipo di forma. E' l'esaltazione della materia che si esprime attraverso l'anima del suo colore. La natura della sua materia, composta da pigmenti vetrosi e pertanto trasparenti, permette al VetroFreddo® di avere uno dei suoi principali punti di forza, e cioè la possibilità di esprimersi in colori trasparenti, traslucidi od opachi. Nessun limite quindi a livello cromatico e, oltre alla gamma di colori già esistente, è possibile scegliere in base alle proprie esigenze, uno dei numerosi colori presenti nella mazzetta "RAL". Il VetroFreddo® ha una resistenza termica di circa 100°C e può essere lavorato con gli stessi utensili del marmo o del vetro. Tutti gli oggetti in VetroFreddo® si possono lavare con qualsiasi tipo di sapone o detergente neutro non granulare, usando panni o spugne non abrasive. In caso di graffi superficiali, si può ripristinare l'oggetto intervenendo con un panno imbevuto di olio d'oliva o una semplice crema per le mani. In caso di graffi più profondi, è possibile ripristinare con una speciale carta vetro suggerita dal produttore in base al colore o al tipo di oggetto.

VetroFreddo® is an innovative material composed of glass pigments and resin. Its major characteristics are its versatility in adapting itself to any form or shape imaginable. The material's unique characteristics are expressed through the soul of its colour, which can be in transparent, semi-transparent or opaque form, due to the material composition of glass pigments. No limits exist in regards to colour. Apart from the existing range of colours, any colour from the "RAL" colour scheme can be chosen. VetroFreddo® is temperature resistant up to approximately 100°C and can be worked with and carved just as marble or glass. All objects designed with the material VetroFreddo® can be cleaned with any type of non-granular soap, using soft sponges or tissues.

In case of superficial damage (scratches), the damaged area should gently be rubbed with a sheet soaked in olive oil.

In case of deeper scratches or damage, a special replacement glass paper is available from the manufacturer for every colour and type of object.



TeknoForm®

TeknoForm® è il materiale delle "texture", costituito da polimeri di varia natura, si esprime dando vita a prodotti monoscocca, esaltando le sue superfici. Dai mosaici alle pietre, dai marmi ai legni, tante soluzioni che danno vita a prodotti unici.

TeknoForm® is a polymer-based material. It expresses itself by enhancing the surface of its products.

From mosaics to stone, from marble to wood, an incredible variety of solutions can be realized in creating unique products.

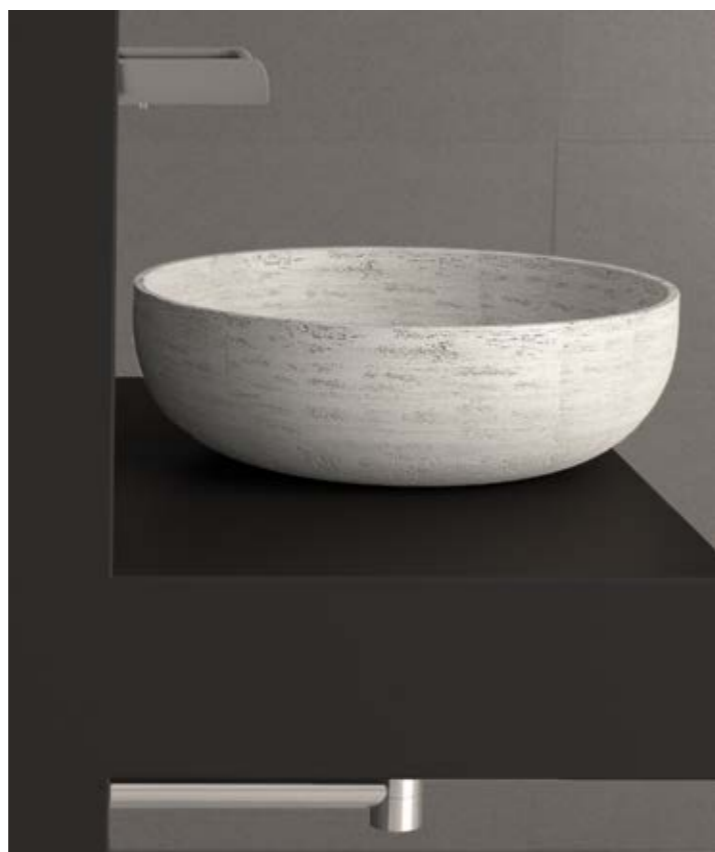

Pert®

polimero tecnologico

Il Pert® è un polimero tecnologico dalle qualità eccezionali, che unisce un basso peso specifico ad un'elevata resistenza meccanica. Particolarmente adatto in quei settori dove l'esigenza della leggerezza del peso è fondamentale (nautico, aereo, camper...). E' un materiale che permette la realizzazione di prodotti di elevato design, eseguiti a regola d'arte, rispettando angoli, raggi, bassorilievi e planarità con la possibilità di scelta tra una vasta gamma di colori, personalizzabili a richiesta. Pert® is a technological polymer of extraordinary quality, combining a low specific weight with high mechanical resistance. It is particularly suited to fields where light weight is essential (e.g. in nautical, aeronautical, camping, ...).

It is a material which enables the creation of products of high design, finely made, allowing perfectly crafted angles and a smoothly plane surface, with the possibility of choosing among a wide range of colours to suit individual demand.



Alumix®

Prodotto hi-tech, elegante e contemporaneo che nasce da una fusione di lega di alluminio. La decorazione è realizzata a pennello, con la tecnica del graffiato, per ottenere un effetto bicromatico. Il bordo è spazzolato e lucidato a mano, per valorizzare l'anima ed il colore tipico di questo materiale.

A high-tech product, both elegant and contemporary, born from a merger of aluminum alloys. The decorations are brush-painted, employing a special brush technique in order to obtain a bi-chromatic effect. The board is brushed and polished by hand to enhance the soul and color, which are typical for this material.



Il progetto Atelier nasce dalla ricerca stilistica che una nostra equipe interna realizza rivolgendo lo sguardo al mondo della moda. I colori e le texture che vengono rappresentati nel programma sono la sintesi delle nuove tendenze.

The "Florence Glass Atelier" project is inspired by embedding the philosophy of the fashion world into product research.

The focus lays on enhancing crystal material with colours and textures of fashion trends.

Nuova tecnologia applicata per dar vita ad un prodotto inox (18/8) tridimensionale.

Peso specifico ridottissimo nonostante i volumi.

Varie sono le espressioni cromatiche dal colore tipico dell'inox lucido, spazzolato fino all'ultima generazione di colori high-tech.

The products of the INOX ZERO Collection are made out of stainless steel (18/8), utilising advanced production processes enabling the combination of expressive design with of low weight. A wide range of colours can be achieved, from timeless metallic shades to prestigious brushed and avant-garde colours.

Siliconio®, ultima generazione della famiglia dei siliconi. Via al design all'insegna dell'elasticità, dalle forme più rigorose che sfruttano le grandi potenzialità di questa materia, a quelle più bizzarre e originali. E' un materiale dalle forti sensazioni tattili: morbido, elastico, sensuale, unico. Siliconio®, quale materiale elastico, può essere sottoposto a torsioni, allungamenti e piegamenti ed in corso di rilascio torna alla sua forma originale. Siliconio® è idrorepellente, antinfortunistico, resistente a temperature tra - 60°C e + 250°C, lavabile, autoestinguente, atossico, dotato di resistenza chimica eccellente.

Siliconio® è Touch design per eccellenza.

Siliconio®, is the latest development in the family of silicone materials. Featuring unique designs based on its elasticity, it allows for rigorous shapes, benefiting from the great potential of the material, being amongst the most unique and original. It is a material of touch: soft, elastic, sensual – simply unique. Siliconio® can be bent and folded in any possible way, always returning to its original form once released. Siliconio®, is water-repellent and, soft, thus reducing the risk of injury, but also resistant to extreme temperatures from -60°C to +250°C, washable, self-extinguishing, non-toxic and with excellent chemical resistance characteristics.

Siliconio® is 'Touch design' at its very best.

La terra come fonte di ispirazione per rappresentare colorazioni e sensazioni tattili con finiture bicolore e texture esterne.

Terra di Siena una collezione di lavabi in ceramica realizzati interamente a mano. Lievi differenze cromatiche e imperfezioni di forma sono testimonianza dell'artigianalità del processo produttivo.

Earth is the source of inspiration for colours and tactile sensations with bi-colour finishes and textural exteriors.

The Terra di Siena collection of ceramic washbasins is made entirely by hand. Slight colour differences and shape imperfections are testimony to the craftsmanship of the production process.





CERTIFICAZIONI
CERTIFICATIONS



Made in Italy

GLASS DESIGN S.R.L.
Via Limitese, 122/124 - 50053 Vinci (Firenze) ITALY
Tel. +39 0571 902311 / +39 0571 902501
Fax +39 0571 902312
glassdesign@glassdesign.it | www.glassdesign.it

Copyright © Glass Design srl. Tutti i diritti riservati - All rights reserved.

Graphic and visual design:
info@giacomomasoni.com

stampato su carta certificata FSC®



Il marchio FSC identifica i prodotti derivanti dal legno, provenienti da foreste gestite in maniera responsabile secondo rigorosi standard ambientali, sociali ed economici.





GLASS DESIGN s.r.l. - Via Limitese 122/124 - 50053 Vinci (Firenze) Italy
tel. +39 0571 902311 / 902501 - Fax +39 0571 902312
glassdesign@glassdesign.it - www.glassdesign.it