

CEQ

# BATH- ROOM











# INCONTRO TRA ARCHITETTURA E NATURA / MEETING BETWEEN ARCHITECTURE AND NATURE

CEADESIGN, nata nel 1984 con l’acronimo lungimirante di CENTRO ENERGIE ALTERNATIVE, colloca il sito produttivo e direzionale a Pove del Grappa, nel distretto bassanese, centro rinomato per tradizione, competenza ed affidabilità del settore metalmeccanico.

La costruzione, abbracciata dalle montagne della Valsugana e costeggiata dal fiume Brenta, è stata realizzata in classe energetica A. La facciata si sviluppa in verticale riprendendo nella sua parte inferiore l’elemento roccioso caratteristico del Monte Grappa e ricreato con il materiale cementizio sotto forma di texture. Le montagne si specchiano nelle grandi vetrate che vanno dai piani interrati al primo piano, propagandosi poi verso la struttura metallica che racchiude il magazzino, interamente realizzata in acciaio inossidabile, materiale di genesi di tutta la produzione CEA, sagomata in modo da ricordare l’acqua del vicino fiume Brenta che caratterizza tutta la zona limitrofa. Grazie alla scelta e all’uso dei materiali specchianti come il vetro e l’acciaio, l’edificio si mimetizza fra i colori della natura circostante, quasi volesse farne parte o tornare ad essere materia naturale, in un circuito che ricorda alcune fra le caratteristiche principali dell’acciaio, ecologia e riciclabilità. Nell’area esterna all’edificio è possibile ammirare l’uliveto di proprietà, l’ampio giardino dove trovano collocazione una varietà di piante autoctone, e l’area parking, adibita esclusivamente alla ricarica dei veicoli elettrici.

Caratteristica principale della costruzione è la verticalità con cui si organizzano gli ambienti, voluta per evitare il più possibile l’impatto dato dall’occupazione del suolo.

Così facendo, in soli 3000 mq di terreno occupato, si sviluppano circa 10000 mq di superficie lavorativa e 35000 metri cubi di edificato. Il comparto produttivo si organizza su tre livelli, dal meno due al piano terra, collocando nei livelli interrati i magazzini automatizzati, la produzione, l’ufficio tecnico e di programmazione, mentre al piano terra si trovano gli uffici commerciale e direzionale, il magazzino del prodotto finito e le aree riservate alla logistica. Nel primo piano trovano sistemazione la cucina riservata al personale dell’azienda, una seconda cucina dedicata all’accoglienza clienti, un auditorium per l’attività di training e un inedito showroom dove trovano collocazione i prodotti CEA.

*CEADESIGN, established in 1984 with the visionary acronym of CENTER of ALTERNATIVE ENERGY, installs the production and management site in Pove del Grappa, in the Bassano district, a center renowned for tradition, competence and reliability in the engineering sector.*

*The building, between mountains of Valsugana valley and Brenta river, was built in energy class A. The façade develops vertically, in its lower part has the characteristic rocky element of Monte Grappa, and recreated with cementitious material in the form of texture. The mountains are mirrored in the large windows that are installed from the basement floors to the first floor, then propagating towards the metal structure that encloses the warehouse, made entirely of stainless steel, the main material of the entire CEA production, shaped as the water of the near Brenta river that characterizes the whole around scenery. Thanks to the choice to use mirrored materials such as glass and steel, the building is camouflaged among the colors of the surrounding nature, as if it wanted to be part of it or go back to being a natural material, in a circle that recalls some of the features of stainless steel, ecology and recyclability. In the area outside the building it is possible to admire the olive grove owned, the large garden where there are a variety of native plants, and the parking area, used exclusively for charging of electric vehicles.*

*The main characteristic of the building is the verticality with which the spaces are organized, used to avoid as much as possible the impact given by the occupation of the ground. In this way, with only 3000 square meters of occupied land, approximately 10,000 square meters of working area in 35,000 cubic meters of construction are developed. The production is organized on three levels, from the minus two to the ground floor, positioning automated warehouses, production, technical and planning departments in the underground levels, while the commercial and management offices, the warehouse for finished products and the logistic zone are on the ground floor. On the first floor there are the kitchen reserved for the company’s staff, a second kitchen dedicated to welcoming customers, an auditorium for training activities and an exclusive showroom where CEA products are located.*

Gli ambienti interni, dalla produzione agli uffici, riprendono gli elementi naturali dell’esterno, attraverso l’utilizzo di materiali come il legno e il vetro con i quali sono realizzati un sistema di boiserie e di divisori per uffici, vani tecnici e di contenimento. Le boiserie di legno di rovere, realizzate con doghe di legno massello, rendono ottimale l’acustica all’interno degli spazi ad uso collettivo quali: androne di ingresso, sale riunioni, auditorium e showroom. L’illuminazione interna, riproducendo la luce naturale del sole, è studiata per garantire migliori performance per chi lavora in quanto, oltre a permettere una migliore visibilità, assicura un maggior benessere psico-fisico.

Grazie alla scelta di sviluppare nell’interrato la maggior parte dell’attività produttiva aziendale, l’utilizzo degli impianti di riscaldamento e raffrescamento è minimo seppur alimentato da fonti energia rinnovabile, coerentemente al principio di sostenibilità a cui si riferisce tutto il progetto aziendale. L’energia, necessaria alla lavorazione e al mantenimento della struttura, viene prodotta da pannelli fotovoltaici collocati sul tetto dell’edificio, mentre l’acqua per i collaudi viene utilizzata a circuito chiuso, perseguendo l’obiettivo del risparmio idrico e di una corretta gestione delle risorse naturali. L’impianto di ventilazione meccanica controllata permette una costante immissione d’aria pulita negli ambienti interni e regola l’umidità mantenendola costante, preservando salute e assicurando il comfort dei lavoratori. Coadiuvanti dei sistemi di raffreddamento e riscaldamento i dieci ventilatori CEA de-stratificano l’aria garantendo una temperatura uniforme in tutti gli ambienti interni.

CEADESIGN realizza i propri prodotti seguendo i principi della sostenibilità energetica in un’ottica di responsabilità sociale. Questo si traduce nella scelta di un processo produttivo a basso impatto ambientale che bandisce l’utilizzo di sostanze inquinanti e di lavorazioni dannose per l’ambiente e per i lavoratori. Con il nuovo sito produttivo CEADESIGN dà la sua risposta in termini di efficienza e sostenibilità sia degli ambienti lavorativi sia dei processi, rivolgendosi così verso il miglioramento della qualità della vita delle persone e dei prodotti che da queste vengono realizzati e utilizzati.

*The spaces, from production to offices, reflects the natural elements of the nature outside, through the use of materials such as wood and glass that are used to create a system of wood paneling and dividers for offices, technical and containment compartments. The wood paneling made with solid wood staves makes the acoustics optimal in the spaces for collective use such as entrance halls, meeting rooms, auditoriums and showrooms. The interior lighting, reproducing the natural light of the sun, is designed to guarantee better performance for who is working, not only to allow better visibility, but also to ensure greater psycho-physical well-being.*

*Thanks to the choice to develop the majority of the company’s production facilities in the basement levels, the use of heating and cooling systems is minimized, even if supplied by renewable energy sources, in line with the principle of sustainability on which the entire project is based. The energy, necessary for the production process and maintenance of the building, is produced by photovoltaic panels placed on the roof of the building, while the water necessary for testing all the products is recycled in a separate circuit, following the objective of saving water and conscious use of natural resources. The intelligent ventilation system allows a constant supply of clean air to the interiors and regulates the humidity, keeping it constant, preserving health and ensuring the well-being of the employees. In addition to the cooling and heating systems the ten CEA fans de-stratify the air, guaranteeing a uniform temperature in all indoor spaces.*

*CEADESIGN produces its own products following the principles of energetic sustainability in a perspective of social responsibility. This translates into the choice of a low environmental impact production process that bans the use of polluting substances and processes that are harmful to the environment and its employees. With the new production site CEADESIGN gives its answer in terms of efficiency and sustainability of both work environments and processes, improving the quality of life of people and the products made and used by them.*





INNOVAZIONE  
TECNOLOGICA  
/  
TECHNOLOGICAL  
INNOVATION



CULTURA  
DEL PRODOTTO  
/  
CULTURE  
OF PRODUCT



DESIGN  
SENZA TEMPO  
/  
TIMELESS  
DESIGN



PRODUZIONE  
MADE IN ITALY  
/  
100%  
MADE IN ITALY



TOTALMENTE  
RICICLABILE  
/  
TOTALLY  
RECYCLABLE



PRODOTTO  
ECOLOGICO  
/  
ECO FRIENDLY  
PRODUCT



RISPARMIO  
IDRICO  
/  
WATER  
SAVING



BASSO IMPATTO  
AMBIENTALE  
/  
LOW ENVIRONMENTAL  
IMPACT

CEA (Centro Energie Alternative) investe il proprio *know-how* nella ricerca e nello sviluppo di soluzioni tecnologiche per la progettazione. La sua *expertise* risale al settore termoidraulico e della progettazione impiantistica, in cui si fondono conoscenza tecnica ed esigenze architettoniche. La ricerca e le specifiche sul prodotto sono accurate e volte a supportare il lavoro di cantiere, con risposte di semplificazione, immediatezza e garanzia di funzionamento. Numerosi i brevetti di invenzione industriale e modelli di utilità, che consentono una spiccata flessibilità progettuale e l'abbattimento dei tempi di cantiere.

*CEA (Centro Energie Alternative) invests its know-how in the research and development of technological solutions for project design. The origins of its expertise trace back to its experiences in the plumbing and installation planning fields, combining technical know-how and architectural demands. The internal research into the product and its peculiarities is careful and aims at supporting the construction work, through simplification, rapid installation and guaranteed operation. Several industrial and utility patents enable a flexible approach to planning and reduce the time of construction.*

CEA si confronta quotidianamente con esperienze reali per fare cultura di prodotto e sviluppare nuove consapevoli idee progettuali. Le tematiche di innovazione tecnologica, sostenibilità e ricerca estetica sono alla base dello studio con le università e degli eventi di formazione organizzati con studi di architettura e rivenditori di tutto il mondo.

*CEA deals with real experiences to enhance a culture of product and share it for the development of new aware project ideas. The themes of technological innovation, sustainability and aesthetic are the founding elements of the research set with universities and training events organized with architect studios and retailers worldwide.*

Geometrie semplici e lineari dimostrano la conoscenza profonda del linguaggio del design e dialogano con l'architettura oltre il tempo. Le collezioni CEA permettono al progettista e all'interior designer una libertà stilistica e di combinazione di prodotto, che conferiscono ampio spazio alle idee per dare forma alla loro realizzazione.

*Simple and linear geometries demonstrate a deep knowledge of design and can dialogue with architecture beyond time. With CEA collections, architects and designers get a total freedom of style and product combination, which gives wide space to ideas and shape to their realisation.*

CEA produce totalmente nel distretto bassanese della Regione del Veneto, centro rinomato per tradizione metalmeccanica, dove qualità e affidabilità sono sinonimo di sinergie locali. Una produzione all'insegna della precisione e dell'ingegneria costruttiva, che coniuga sapere artigiano, innovazione tecnologica e sostenibilità.

*CEA totally produces in the Bassano del Grappa district of the North East of Italy, worldwide renowned area for the mechanical engineering tradition, where quality and reliability derive from local synergies. The production process is characterised by precision and manufacturing engineering: simplicity and craftsmanship guide technological innovation and sustainability.*

Per domare l'acqua, CEA sceglie l'acciaio inossidabile AISI 316L, materiale ad altissime prestazioni e totalmente riciclabile. La cura nella scelta di materie prime a basso contenuto di carbonio permette a CEA di non aggiungere verniciature, trattamenti galvanici o trasformazioni chimiche al processo produttivo. Il risultato è una gamma prodotto fortemente igienica, atossica e totalmente riciclabile.

*To master the flow of water, CEA chooses AISI 316L stainless steel, a totally recyclable and highly performing material. The raw material, characterised by low levels of carbon, is carefully selected and enables CEA not to involve hot melting, painting, galvanic treatment or other chemical processes during production. Resulting CEA taps do not to release any toxic elements into water, are highly hygienic and totally recyclable.*

La caratteristica durezza dell'acciaio inossidabile AISI 316L garantisce una lunga durata dei prodotti CEA nel tempo, resistente a graffi e scalfitture, agenti esterni, salsedine ed acque sulfuree. Le caratteristiche del materiale sono la prima garanzia della qualità dei prodotti CEA, eterni ed ecologici.

*The distinctive hardness of the AISI 316L stainless steel guarantees long life of CEA products over time, resistance to scratches and nicks, external agents, saltiness and sulphurous waters. The characteristics of the material represent the primary guarantee of CEA products quality, eternal and eco-friendly.*

In tutta la collezione CEA l'erogazione dell'acqua è regolata da aeratori e limitatori, che riducono la portata del flusso a 5 l/min, e da cartucce progressive, che mantengono costante il getto a 5 l/min, permettendo la regolazione della temperatura con un solo gesto. Entrambi i sistemi assicurano un notevole risparmio idrico rispetto ai tradizionali miscelatori.

*In CEA product range, the water flow is adjusted by aerators and limiters (reducing the flow to 5 l min) and by progressive cartridges (allowing a constant water flow to 5 l/min while permitting temperature adjustment, with just one movement). Both systems ensure a remarkable water saving, compared to traditional taps.*

CEA lavora l'acciaio a freddo, senza influenzare il surriscaldamento termico ambientale. Il processo produttivo aziendale prevede l'utilizzo esclusivo di fonti energetiche rinnovabili certificate, la raccolta differenziata dei rifiuti ed il risparmio dell'acqua, per ridurre l'impatto dell'azienda sull'ecosistema. Tramite centri di lavoro a controllo numerico (torni, frese e tagli al laser) la precisione e la qualità della lavorazione conseguono eccellenti risultati. Anche le finiture sono ottenute per procedimenti meccanici ecocompatibili.

*CEA adopts only cold working methods for stainless steel and does not influence global warming. All the energy that powers production is certified clean, water is saved and waste is separated to be recycled, to reduce the impact of the company on the ecosystem. Thanks to precision CNC machines (lathes, milling and laser cutting) the quality of the production process achieves excellent results. Finishes are also obtained through environmentally-friendly mechanical processes.*



# LA FORZA INNOVATIVA DELLA TECNOLOGIA / THE POWER OF TECHNOLOGICAL INNOVATION

Le collezioni CEA esprimono una forte attitudine alla tecnologia applicata a funzionalità e reinterpretazione del prodotto.

Grazie all'expertise maturata in cantiere e alla continua ricerca di nuovi materiali, sistemi di funzionamento, tecnologie idrauliche e tecniche costruttive, l'azienda ha registrato numerosi brevetti di invenzione industriale e modelli di utilizzo. Le parti ad incasso CEA garantiscono velocità e facilità di installazione, precisione ed abbattimento dei tempi di cantiere. L'utilizzo di materiali alternativi conferisce originalità e creatività alle collezioni CEA.

*The CEA collection of taps expresses a strong attitude for functional technology and product re-interpretation.*

*Thanks to CEA's expertise gained on construction sites and via the continuous research for new materials, operation systems, hydraulic technologies and manufacturing techniques, the company has registered several industrial and utility patents. The CEA built-in parts ensure fast and easy installation, precision, and a reduction of time on the construction site. The use of alternative materials ensure the CEA collections are original and creative.*

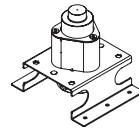

INC

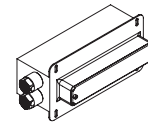

BOX

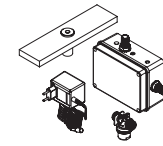

IRS  
INFRARED SENSOR

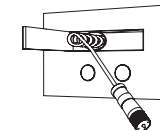

HYDROPLATE

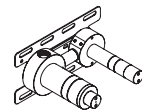

PTR  
PLUMBING TELESCOPIC  
REGULATOR

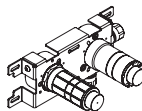

PWF  
PIPE WATER FITTING

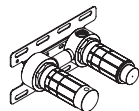

UCS  
UNIVERSAL CARTRIDGE SY-  
STEM

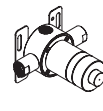

ACQUA STOP SYSTEM

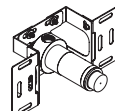

FIX

Corpo incasso universale che permette una regolazione in profondità nella parete non modificando l'estetica del prodotto. Con il PTR è possibile intercambiare fra loro numerose collezioni. Inoltre, si ottiene un vantaggio straordinario nei lavori di cantiere, evitando l'utilizzo di prolunghe e di strumenti da taglio per adattare la parte incasso alla rubinetteria e quindi accorciando i tempi di lavoro. Il PTR è un modello di utilità CEADDESIGN.

*The PTR is a universal built-in part that allows adjustability in its depth into the wall and is also interchangeable with a number of collections. The PTR is a great advantage on the building site, it avoids the use of extensions and cutting tools to adapt the built-in part to the taps and also reduces installation time. The PTR is a CEADDESIGN utility model.*

Raccordo universale all'impianto idraulico che permette un innesto rapido del rubinetto a parete ed una conseguente velocità e facilità dell'installazione. Con il PWF la miscelazione dell'acqua rimane esterna al muro ovviando ogni tipo di problematica connessa all'installazione della rubinetteria a parete. Il PWF è un brevetto CEADDESIGN di invenzione industriale.

*The PWF is a universal fitting that enables a quick and easy connection of the tap to the wall. With PWF system, the mixing parts of the tap, including the cartridge, are located at the front of the wall. The PWF is fully adjustable and this removes any problems of fitting the tap to un-even or un-level walls. It also makes any future service requirements very easy. The PWF is a patent by CEADDESIGN for industrial invention.*

Corpo incasso universale privo di finitura estetica, intercambiabile rispetto alle collezioni CARTESIO, INNOVO, MILO360 e GASTONE. Inoltre, con il corpo ad incasso UCS è possibile bloccare la temperatura massima dell'acqua tramite la regolazione di un ghiera posta sulla cartuccia miscelatrice. UCS è un brevetto CEADDESIGN di invenzione industriale.

*The UCS is a universal built-in part without aesthetic finish, interchangeable across CARTESIO, INNOVO, MILO360 and GASTONE collections. In addition, with the UCS built-in part the maximum water temperature can be locked by adjusting a metal ring placed on the mixer cartridge. The UCS is a patent by CEADDESIGN for industrial invention.*

Rubinetto termostatico con sistema di chiusura automatica dell'acqua. Il ACQUA STOP SYSTEM permette di evitare la chiusura dell'impianto al momento dell'estrazione della cartuccia per la manutenzione straordinaria. Sistema certificato per il mercato americano. Brevetto di invenzione industriale CEADDESIGN.

*Thermostatic mixer with automatic ACQUA STOP SYSTEM. It permits to avoid the plumbing closure during the cartridge pulling out for the extraordinary maintenance. Certificate system for american market. CEADDESIGN patent for industrial invention.*

Staffa di fissaggio per l'ancoraggio di colonne doccia/vasca, bocche di erogazione, doccini e soffioni su pareti, controsoffitti e pavimenti.

*The INC is a fixing bracket used to anchor shower and bathtub fittings, including water spouts, hand showers and shower heads on to the walls, false-ceilings and floors.*

Sistema di installazione della rubinetteria a parete tramite una scatola vuota a incasso per l'alloggiamento dei tubi flessibili. Il BOX non include cartucce di miscelazione dell'acqua che sono invece fornite con la parte esterna del rubinetto.

*The BOX installation system is used for wall-mounted taps and includes a built-in empty box where the supply hoses of the hot and cold water are located. The BOX system also allows all working parts of the tap to be located at the front of the wall, which assists with any future service requirements.*

Sistema di rilevazione di presenza a raggi infrarossi alimentato a batteria con voltaggio 9 volt o corrente elettrica, abbinabile a erogazioni da piano, parete, soffitto e pavimento. Il sensore può essere posizionato sul piano o sul fronte di un top e azionabile rispettivamente avvicinando il palmo della mano al sensore o avvicinando il corpo in prossimità del lavabo.

*The IRS is a presence detection system using infrared technology and is powered with 9 volts or standard electric current. The IRS can be combined with wall, deck or ceiling mounted outlets and can also be used with freestanding taps. The sensor can be placed vertically on the wall or horizontally on the countertop. The sensor is activated when a hand or other body part comes close to the sensor location, which then in turn activates the tap.*

HYDROPLATE è un innovativo programma di placche per cassetta WC, dotate di pulsanti a filo e idroscopino a scomparsa per la pulizia del WC e per l'igiene intima. Brevetto di invenzione industriale di CEADDESIGN, HYDROPLATE non necessita di predisposizione impiantistica né di opere murarie poiché si collega all'impianto della cassetta WC. Il risparmio idrico è garantito dal doppio flusso a 3 e 6 litri della cassetta. Completano la gamma gli idroscopini ad incasso o esterni abbinabili alle diverse collezioni di accessori CEA.

*The HYDROPLATE is an innovative program of WC flush plates for use with concealed cisterns. They are equipped with flush buttons and a rollaway water jet cleaner which can be used to clean the WC or for personal hygiene. A CEADDESIGN industrial invention patent, the HYDROPLATE takes its water supply directly from the pipe that is feeding the concealed cistern. Water saving is guaranteed by the 3 and 6 liters dual flush capacity of the concealed cistern. The range is completed with the built-in or external water jet cleaners, which also match the different CEA accessory collections.*

Doppia staffa di fissaggio ausiliaria opzionale ad "L" da utilizzarsi a completamento delle staffe di fissaggio di PTR, PWF, UCS e INC. FIX permette la regolazione e il fissaggio della rubinetteria in profondità, vs l'alto e il basso, vs sinistra e destra, in obliquo. FIX è indicato nei lavori di precisione e per strutture di cartongesso/fibrogesso.

*Optional auxiliary fixing with double "L" bracket to be used with built-in parts PTR, PWF, UCS e INC. It allows faucet regulation in depth, upward and downward, left and right, obliquely. FIX is recommended in precision work and plasterboard/fiberboard structures.*





**DOUBLE MOVEMENT MIXER**  
GIOTTO + COLLECTION

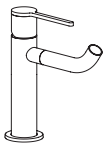

**INNOVO**



**DUET**



**ROUND HAND SHOWER**  
FREE IDEAS



**BLACK DIAMOND**



**BRONZE / COPPER /  
LIGHT GOLD**



**WOOD ESSENCES**

Miscelatore monocomando a piano o a parete con spessore 20 mm, brevetto CEADDESIGN. L'innovazione industriale riguarda la possibilità di avere un comando di miscelazione che regola portata dell'acqua e temperatura con due diverse gestualità, rispettivamente un cursore di apertura e chiusura e un moto di rotazione per regolare la temperatura dell'acqua. Con questi due diversi movimenti CEA inventa un modo nuovo di utilizzare il miscelatore mantenendo ingombri minimi di spessore del prodotto stesso. Il MISCELATORE DOPPIO MOVIMENTO è un brevetto CEADDESIGN di invenzione industriale.

*A single handle mixer, deck- or wall-mounted, with 20 mm depth and also a CEADDESIGN patent. The industrial innovation of this technology relates directly to the possibility of having one mixer regulating water flow and temperature using two different functions. A sliding motion controlling the water flow and a rotational motion for adjusting the water temperature. Thanks to these two different movements, CEA has invented a new use for the mixer, while maintaining minimum overall dimensions. The DOUBLE MOVEMENT MIXER is a patent by CEADDESIGN for industrial invention.*

Miscelatore a piano monocomando con bocca girevole per getto a zampillo. La torsione della bocca di erogazione permette una riduzione del flusso dell'acqua a 3 l/min. Ruotando di 180°, l'erogazione dell'acqua raggiunge una portata di 4 l/min per facilitare l'uso dello zampillo nella gestualità quotidiana. Modello di utilità CEADDESIGN. È un progetto di Natalino Malasorti.

*Deck mounted single handle mixer with swivelling spout for gush flow. The rotation of the spout permits a reduction of the water flow to 3 l/min. Rotating the spout of 180 ° the water flow reaches 4 l/min to facilitate the gush use in daily gestures. CEADDESIGN utility model. Design by Natalino Malasorti.*

Collezione prodotto caratterizzata dal dualismo cerchio/quadrato, enfatizzata dalla differenza di finitura satinata per l'uno e lucidata per l'altro. Le due forme si innestano tra loro conferendo tridimensionalità alla maniglia del rubinetto. Modello ornamentale CEADDESIGN. È un progetto di Mario Tassarollo e Daniela Lorato.

*Product collection characterized by the circle/square dualism, emphasized by the difference of satin finish for the former and polished for the latter. The two forms are combined giving three-dimensionality to the faucet handle. CEADDESIGN ornamental model. Design by Mario Tassarollo and Daniela Lorato.*

Prodotto realizzato da CEADDESIGN STUDIO e caratterizzato da un disco integrato nell'asta del doccia. L'erogazione produce un getto a pioggia areato particolarmente morbido. Il tubo flessibile è disponibile nella versione con treccia inox (FRE94 - FRE192) e in gomma siliconica colorata (FRE95 - FRE193). Modello ornamentale CEADDESIGN.

*Made by CEADDESIGN STUDIO and characterized by an integrated plate in the shaft of the hand shower. The water flow produces a particularly soft aerated rain jet. The hose is available with stainless steel version (FRE94 - FRE192) and colored silicone rubber (FRE95 - FRE193). CEADDESIGN ornamental model.*

Esclusiva finitura nera di CEA per l'acciaio inox effettuata tramite trattamento di deposizione per evaporazione. Enfatizza le naturali qualità del materiale risaltandone la finitura satinata o lucidata. Un film biocompatibile a base di grafite e polvere di diamante, aumenta la lucentezza e il grado di durezza della superficie. Ne conseguono maggiore resistenza a soluzioni acide, basiche e solventi, incolumità verso scalfitture e graffi, autolubrificabilità rispetto ai depositi calcarei dell'acqua.

*Exclusive CEA black finish for stainless steel resulting from a deposition process through evaporation. It emphasizes the natural qualities of the material, highlighting the satin or polished finish. A biocompatible film based on graphite and diamond powder, increases the gloss and the hardness of the surface. The result is an extraordinary resistance to acid, basic solutions and solvents, safety from nicks and scratches, self-lubrication against water lime scales.*

Finitura applicata all'acciaio inox che enfatizza le naturali qualità del materiale risaltandone la finitura satinata o lucidata. Effettuata tramite trattamento di deposizione per evaporazione, garantisce durezza e lucentezza attraverso un film biocompatibile che riveste la superficie.

*Stainless steel finish that emphasize the natural qualities of the material, highlighting the satin or polished treatments. Resulting from a deposition process through evaporation, it guarantees the hardness and the gloss through a biocompatible film that coats the steel surface.*

ROVERE, TEAK BIRMANO, NOCE AMERICANO e WENGÉ sono le quattro esclusive essenze che CEA abbina ai comandi delle collezioni GIOTTO, ZIQQ e BAR. Il binomio Acciaio/Legno prosegue il percorso dell'azienda e ribadisce l'ecologia quale *fil-rouge* di tutta la sua produzione. Il legno massello stagionato, proveniente da foreste certificate, è trattato con vernici all'acqua brevettate, prive di solventi. Come l'acciaio inossidabile, anche il legno si contraddistingue per durezza, ottimo grado di stabilizzazione rispetto ad umidità e temperatura, impermeabilità e resistenza a soluzioni acide e saline. Queste caratteristiche rendono il prodotto adatto anche all'ambiente marino.

*OAK, BURMA TEAK, AMERICAN WALNUT AND WENGE are the four exclusive wood species CEA teams up with the controls of GIOTTO, ZIQQ and BAR collections. The Steel/Wood combination continues to characterize the design experience of the company and further confirms environmental awareness as being the connective thread of the entire production. Mature solid wood, sourced from certified forests, is treated with patented water-based and solvent-free varnishes. Similarly to stainless steel, the wood also stands out for its hardness, together with an excellent degree of stability in the presence of humidity or extreme temperatures and resistance to acidic and saline solutions. These characteristics also make our products ideal for the marine environment.*



# MASSIMA LIBERTÀ COMPOSITIVA / MAXIMUM FREEDOM OF COMPOSITION

FREE IDEAS è un concetto sviluppato da CEA per garantire al progettista la massima libertà compositiva. Molti prodotti CEA sono trasversali ed il loro utilizzo si estende a tutte le collezioni. In questo modo, ogni singola collezione amplia la propria gamma compositiva e presta le proprie erogazioni a tutte le altre serie di prodotto.

*FREE IDEAS is a concept developed by CEA to ensure the maximum freedom of composition for the designer. A wide range of CEA products are transversal as their use extends to all product collections. As a consequence each collection is enriched with a wider range of possible compositions.*

Esempi d'installazione lavabo / *Examples of washbasin installation*

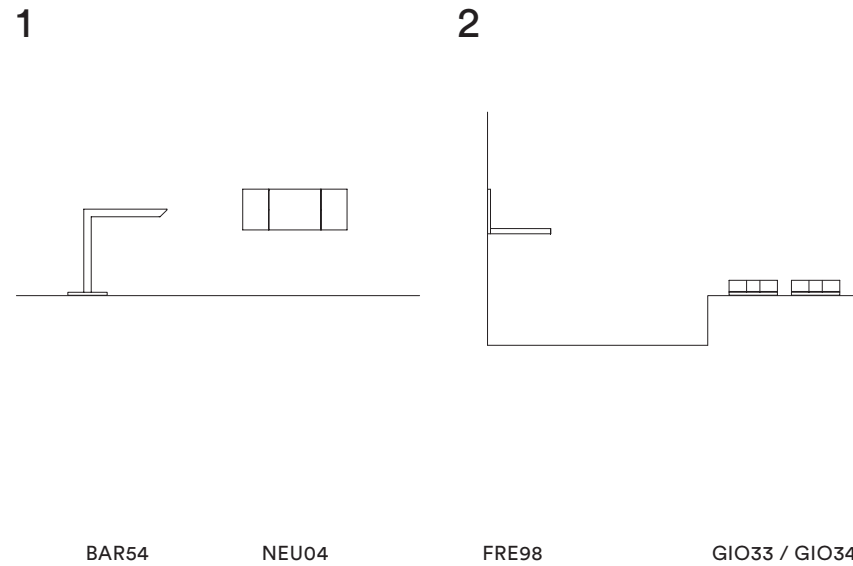

Esempi d'installazione lavabo free-standing / *Examples of free-standing washbasin installation*

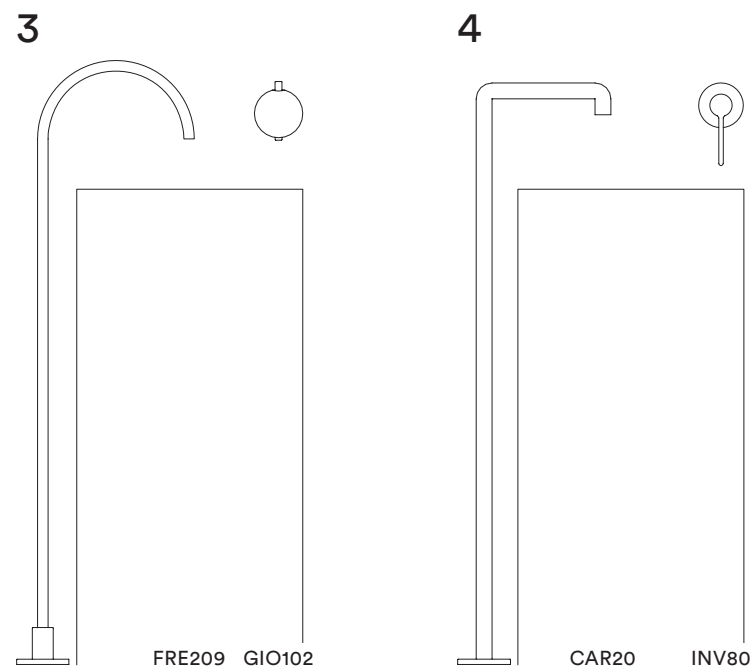

Esempi d'installazione doccia / *Examples of shower installation*

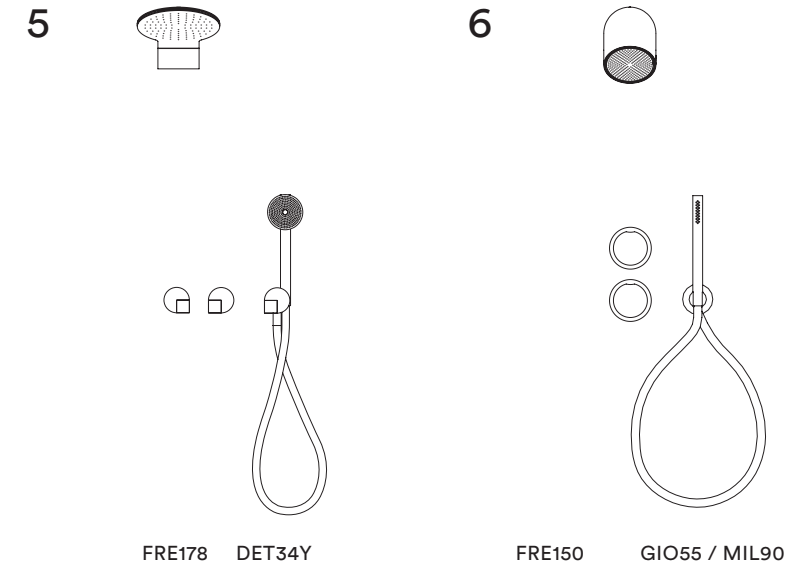

Esempio d'installazione vasca / *Example of bathtub installation*

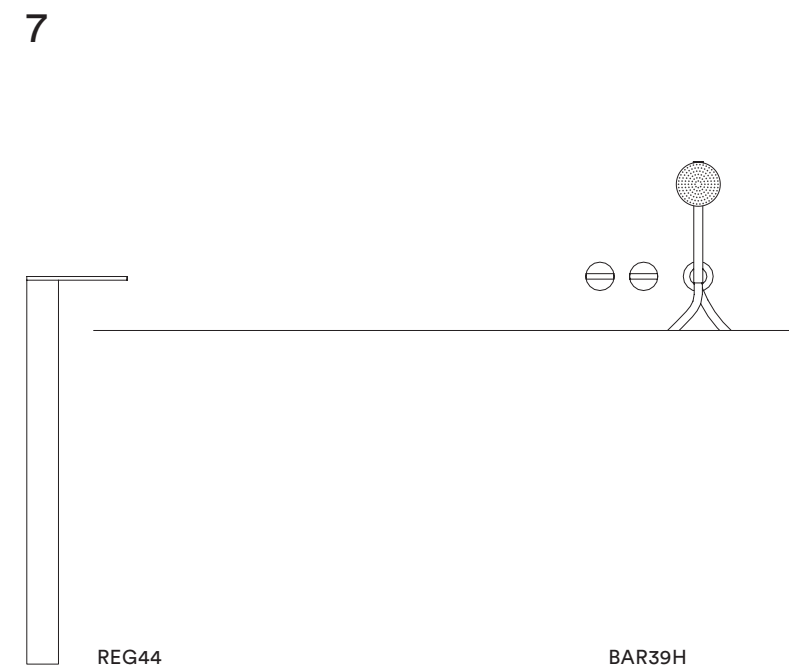

# SUPPORTO TECNICO / TECHNICAL SUPPORT

CEA lavora con e per i progettisti, per lasciare spazio alle idee e garantire la loro migliore realizzazione. La specificità di cantiere è occasione di confronto tra progettazione e cultura aziendale di prodotto, con il fine di ridurre tempi e costi di cantiere, per ottenere risultati di eccellenza. CEALab è il dipartimento di consulenza e sviluppo di progetto a supporto delle diverse fasi del lavoro di architetti e interior designer. Risponde all'email [cealab@ceadesign.it](mailto:cealab@ceadesign.it)

*CEA works both with and for designers, so that their ideas are given free reign and their designs realised. The specification of the construction site is an opportunity for project design and culture of product to meet. This enables a reduction in time and cost of construction, which in turn creates excellent results. CEALab is the company department of project consulting and development supporting the work of architects and interior designers at different phases through their projects. For project support, please contact [cealab@ceadesign.it](mailto:cealab@ceadesign.it)*

# LA PASSIONE PER L'ACCIAIO INOSSIDABILE / THE PASSION FOR STAINLESS STEEL

L'acciaio inossidabile è una lega a base di ferro e carbonio che per passivazione, cioè attraverso una pellicola protettiva che si forma a contatto con l'aria, diventa resistente alla corrosione da parte degli agenti esterni e soprattutto resistente alla ruggine. In commercio ne esistono più tipi, comunemente identificati con la sigla AISI (acronimo inglese dell'Istituto statunitense per il ferro e l'acciaio - American Iron and Steel Institute) che ne codifica il tipo con tre cifre (AISI 304, AISI 316, AISI 430, ecc.) e l'eventuale aggiunta di una lettera che specifica la presenza di un particolare componente nella struttura della lega. CEA ha scelto di lavorare con l'acciaio AISI 316L per tutta la rubinetteria, dove L sta per low carbon, cioè basso contenuto di carbonio, che impedisce alle impurità di penetrare. L'AISI 316L è un tipo di acciaio molto resistente alla corrosione, quindi particolarmente adatto nelle zone marine, termali e dovunque si registri un alto inquinamento atmosferico. L'acciaio è un materiale inerte (non emette sostanze nocive per l'ambiente o per l'uomo a contatto con l'aria o l'acqua) che, a differenza dell'ottone, non richiede ulteriori trattamenti (né galvaniche né verniciature) mantenendosi quindi puro e altamente igienico.

CEA ha scelto l'acciaio in rispetto dei principi di sostenibilità e di salvaguardia dell'ambiente e delle sue risorse. L'acciaio inossidabile è universalmente considerato un materiale ecologico che per essere prodotto richiede temperature molto inferiori a quelle utilizzate per la produzione di altri metalli. CEA inoltre adotta meccanismi di lavorazione dell'acciaio inox a freddo, ossia con l'ausilio esclusivo delle macchine a controllo numerico di altissima precisione. Le finiture che CEA adotta per le superfici delle sue collezioni sono realizzate a mano con spazzole che levigano, lucidano e satinano. La sapienza e l'esperienza dell'artigianato di CEA conferiscono qualità alla lavorazione. Nessun trattamento di termo fusione viene utilizzato per la produzione di CEA, evitando pertanto il conseguente surriscaldamento termico. La caratteristica di materiale ecologico è conferita anche dalla durata di vita dei prodotti. La resistenza meccanica determina infatti la durevolezza dell'acciaio e quindi dei suoi manufatti. Oltre a essere riciclabile al 100%, l'acciaio promette una vita praticamente eterna.

*Stainless steel is an alloy made by combining iron and carbon that becomes resistant to corrosion from external agents and rust, thanks to passivation, that is a protecting film that steel forms when exposed to air. There are many types of stainless steel, which are commonly identified with AISI (the acronym of the American Iron and Steel Institute), which specifies the kind of steel with a three-digit number (AISI 304, AISI 316, AISI 430, etc.) and then it may be integrated with a letter specifying a particular component in the structure of the alloy. CEA has decided to work with AISI 316L for all its taps, where L stands for low carbon, which prevents impurities from penetrating the alloy structure. AISI 316L is very resistant to corrosion, therefore ideal at seaside and spa areas and wherever pollution is high. Steel is an inert material (it does not send out substances toxic to mankind and the environment when exposed to air or water), which, unlike brass, does not need any further treatment (such as galvanic treatment or varnishing), thus keeping its purity and being extremely hygienic.*

*CEA has chosen steel in compliance with the principles of sustainability and respect of the environment and its resources. Stainless steel is universally recognised as an eco-friendly material that needs far lower temperatures to be produced in comparison to other metals. CEA adopts cold working methods for stainless steel, with the exclusive help of highly precise numerical control machines. CEA adopts handmade finishes for its collections obtained by smoothing, polishing and brushing. The wisdom and experience of CEA's craftsmanship ensures a quality production. No hot melt treatment is used at CEA, which avoids the resulting thermal overheating. The long-term life of the products confirms the eco-friendliness of stainless steel and its mechanical resistance determines the durability of steel and its products. Not only is steel 100% recyclable, but also almost eternal.*



because ideas can be hot and cold

## INDEX

### BATHROOM

giotto	25
giotto plus	39
lutezia	53
lutezia plus	63
flag	73
cross	83
duet	93
opus	111
regolo	119
ziqq	129
bar	143
asta	153
neutra	165
circle	183
gradi	195
gastone	209
innovo	219
cartesio	229
milo360	241
electronic taps	255
stem	263
hydroplate	269
wellness	289
equilibrio	305



giotto

DESIGN NATALINO MALASORTI







GIO21S



GIO22S



GIO25WS + FRE232S







GIO05S



GIO01S



GIO03S



GIO02S

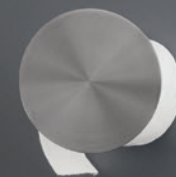

GIO06S



POS06S

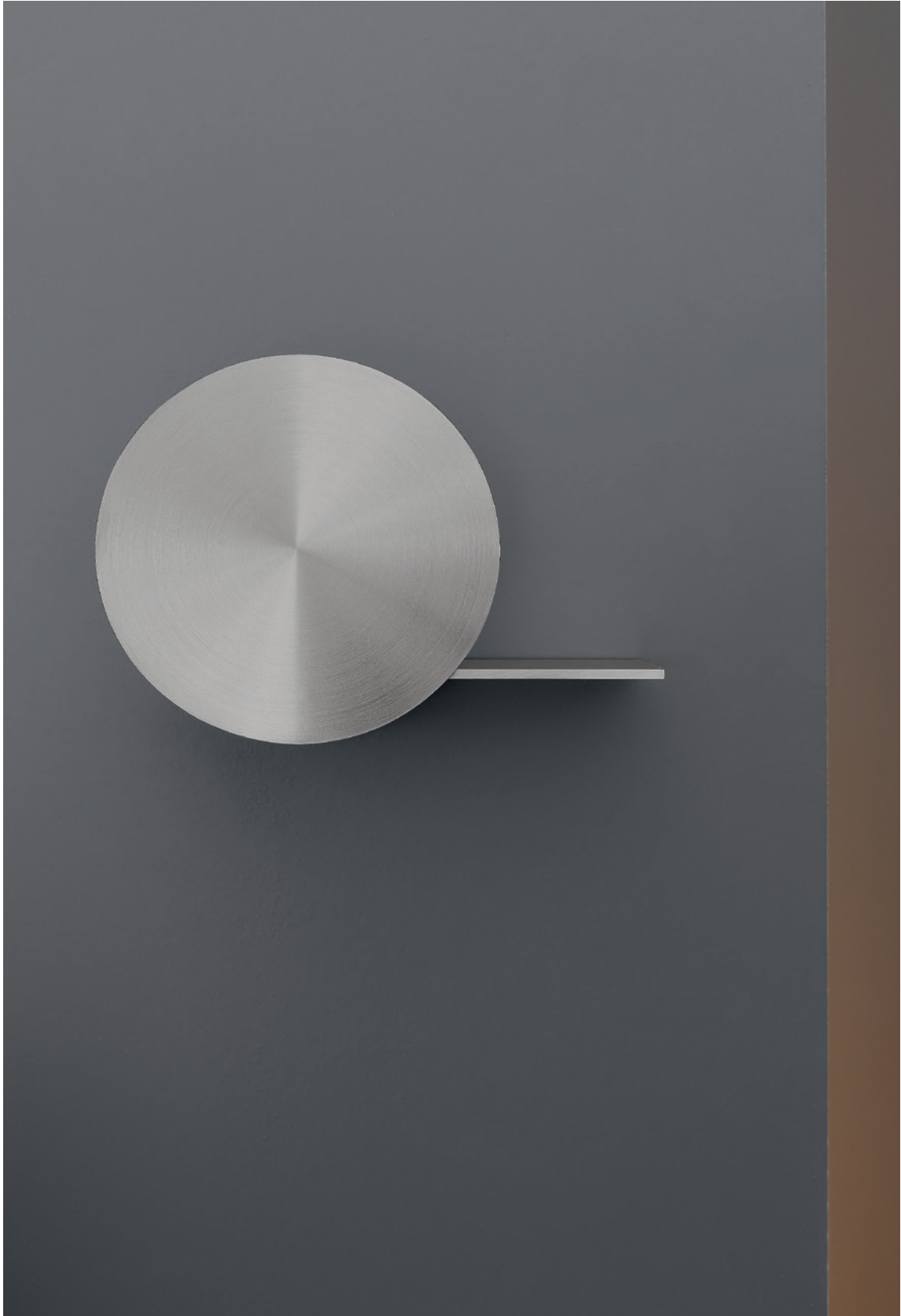

GIO05S

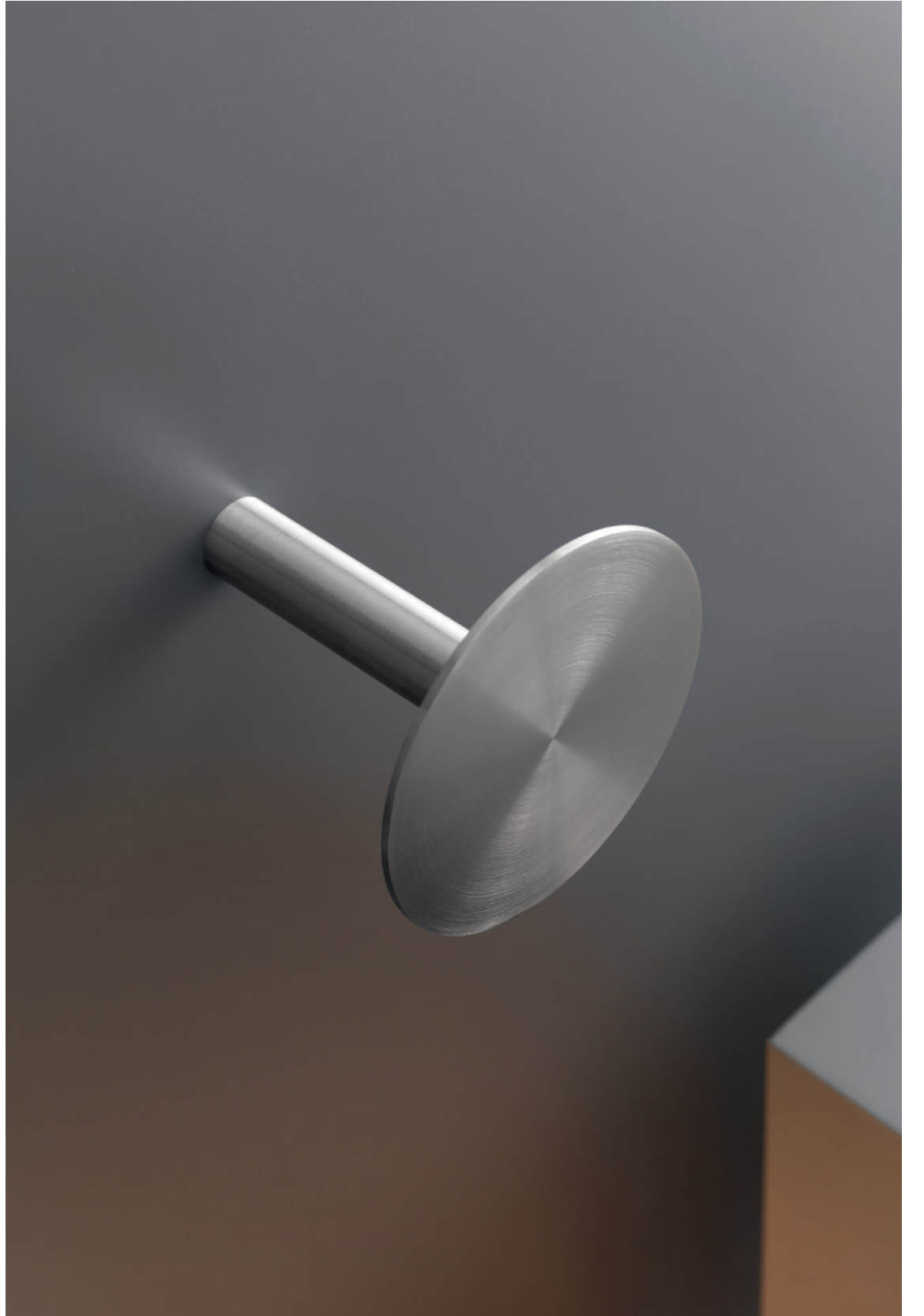

GIO06S

# giotto plus

DESIGN NATALINO MALASORTI





GIO102S



GIO71S











GIO69S



GIO83SGS



GIO82SGS





# lutezia

DESIGN JEAN-MICHEL WILMOTTE





LTZ11S





LTZ31SGS + FRE224S + BRA02S



LTZ31SGS



# lutezia plus

DESIGN JEAN-MICHEL WILMOTTE





LTZ22S



LTZ81S



LTZ27S





LTZ97S



flag

DESIGN NATALINO MALASORTI



FLG04S







FLG06S



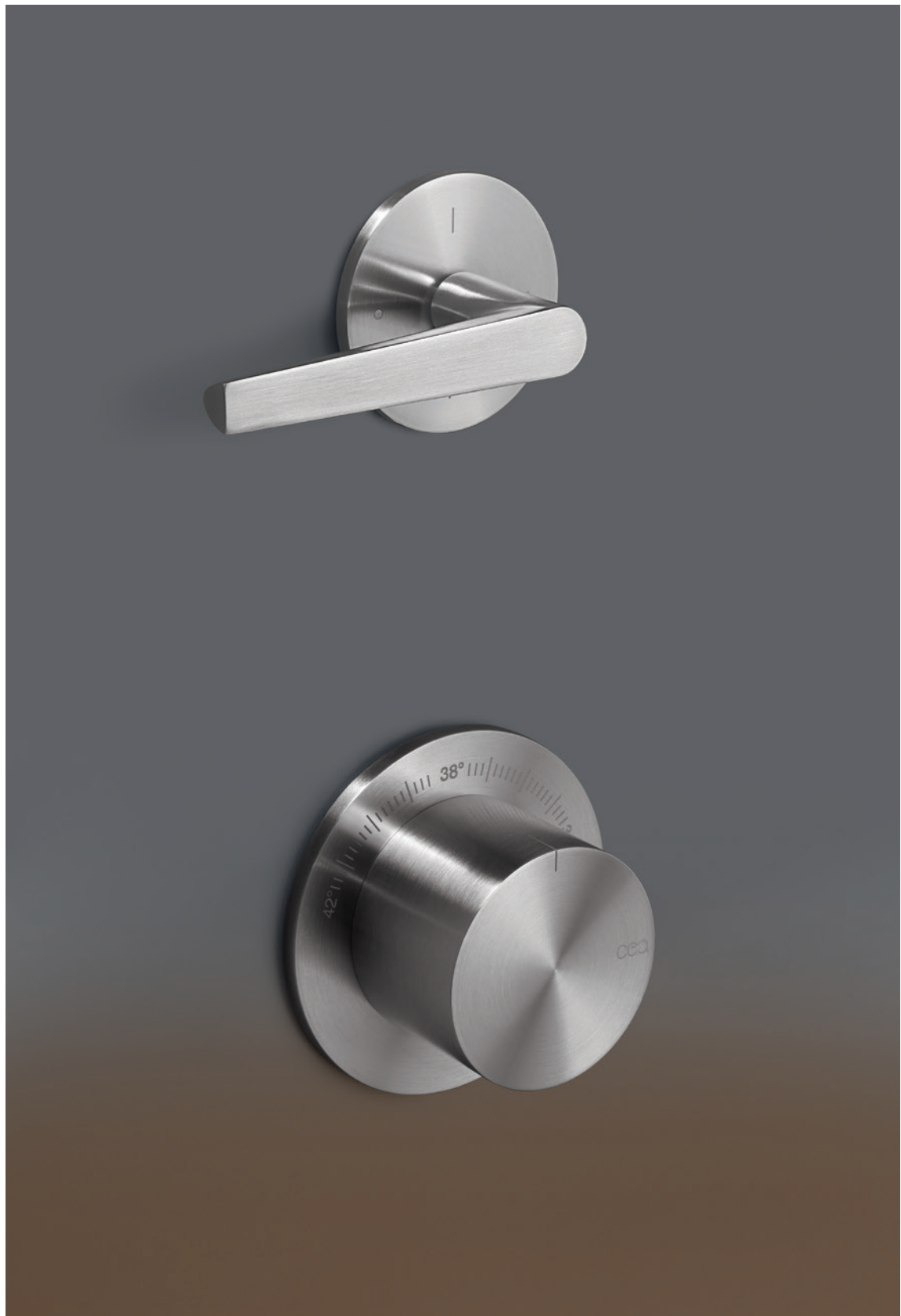

FLG50S



FLG50S + MIL90WS + FRE41S



**cross**

DESIGN NATALINO MALASORTI



CRX12S

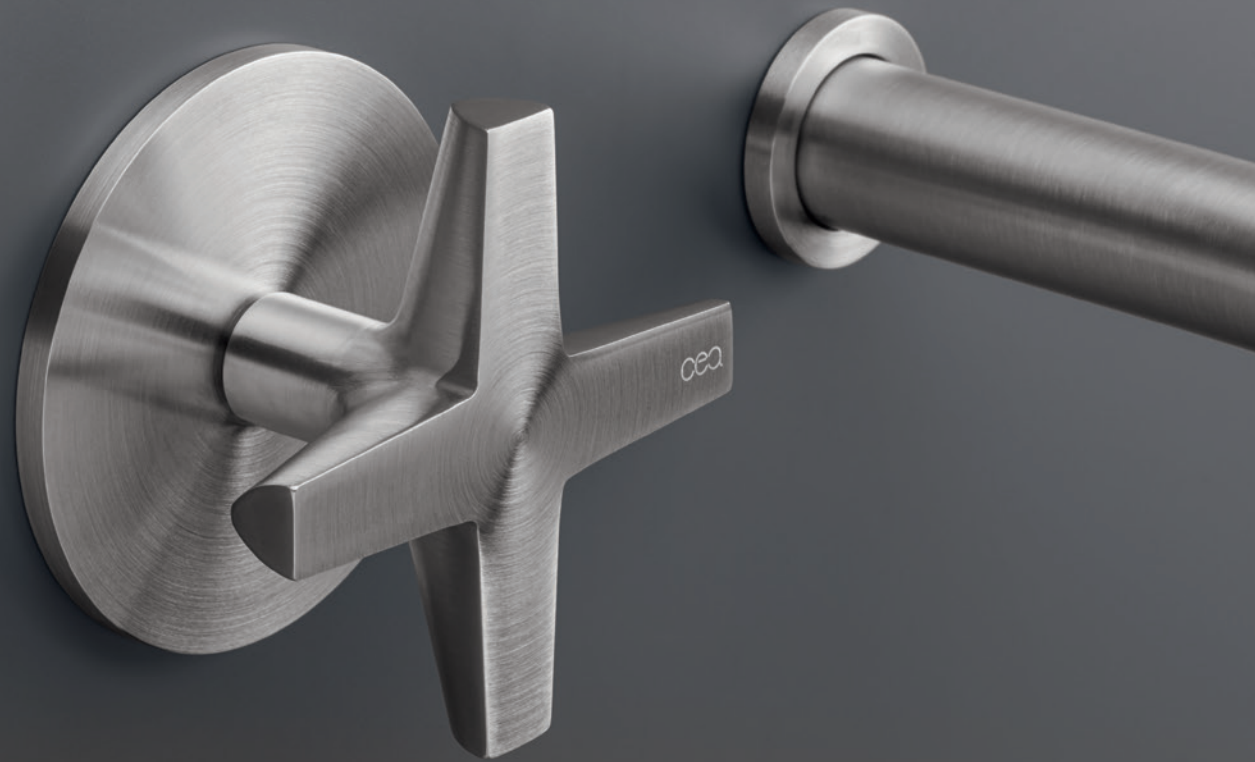





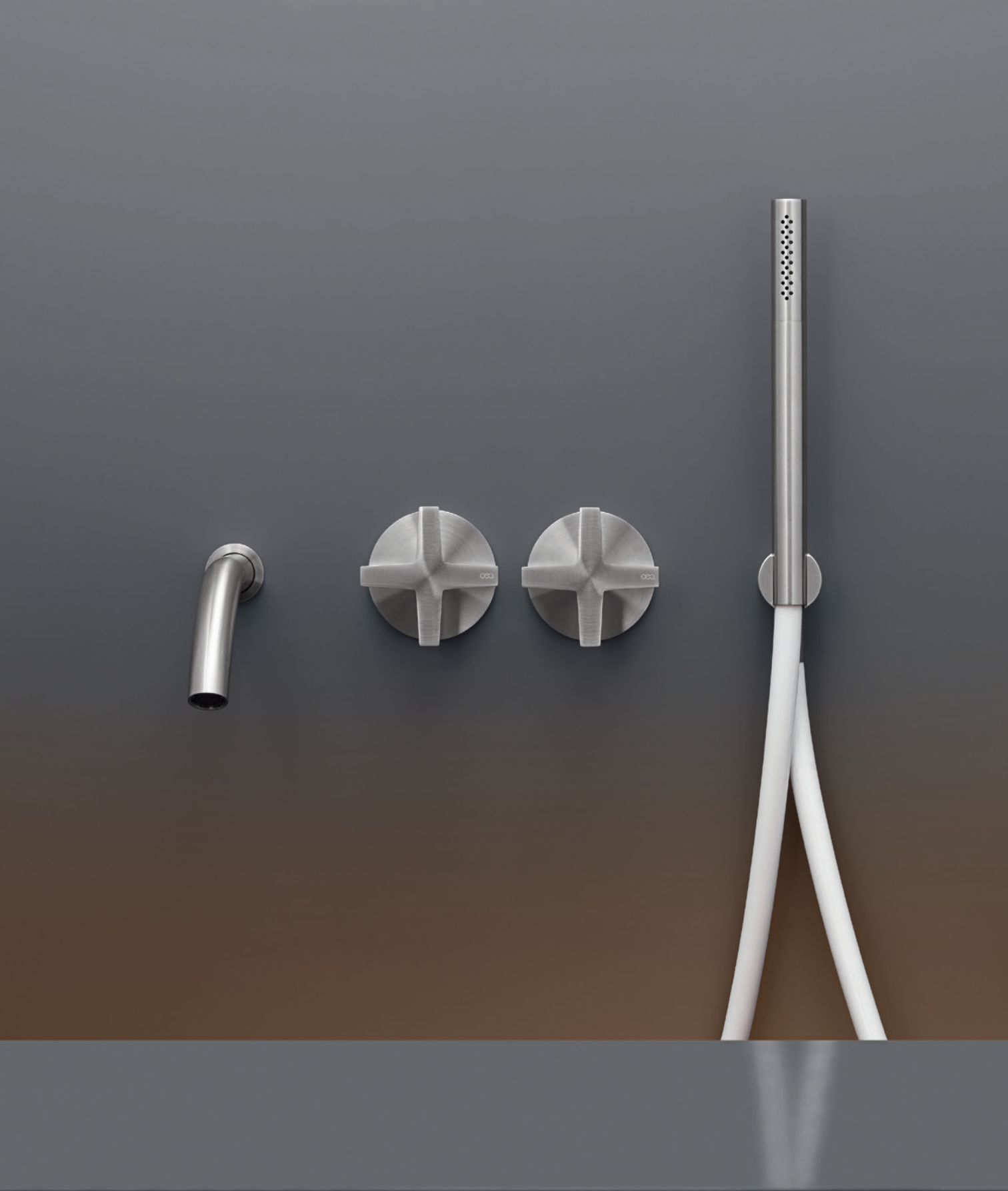

CRX23WS

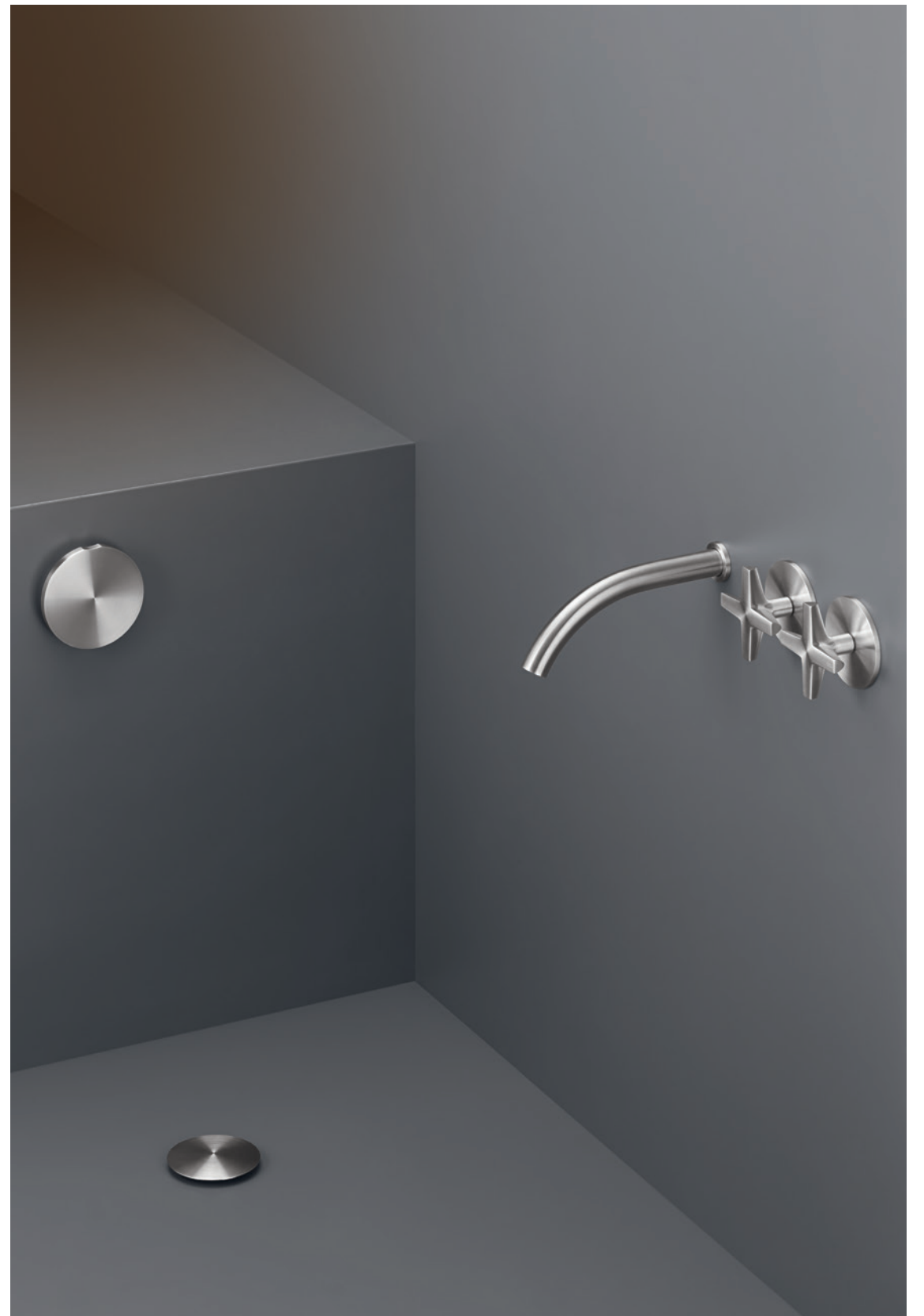

PIL10S



CRX22WS + AST24WS



AST24WS

# duet

DESIGN MARIO TESSAROLLO, DANIELA LORATO



DET13S







DET21S



DET05S



2 DET40S + MIL90WS + FRE34S



DET34YWS



DET107S

DET105S

DET117S

DET112S

2 DET114S

DET104S

DET120S

DET121S







DET117S + DET112S



DET107S



opus

DESIGN BRUNO ERPICUM



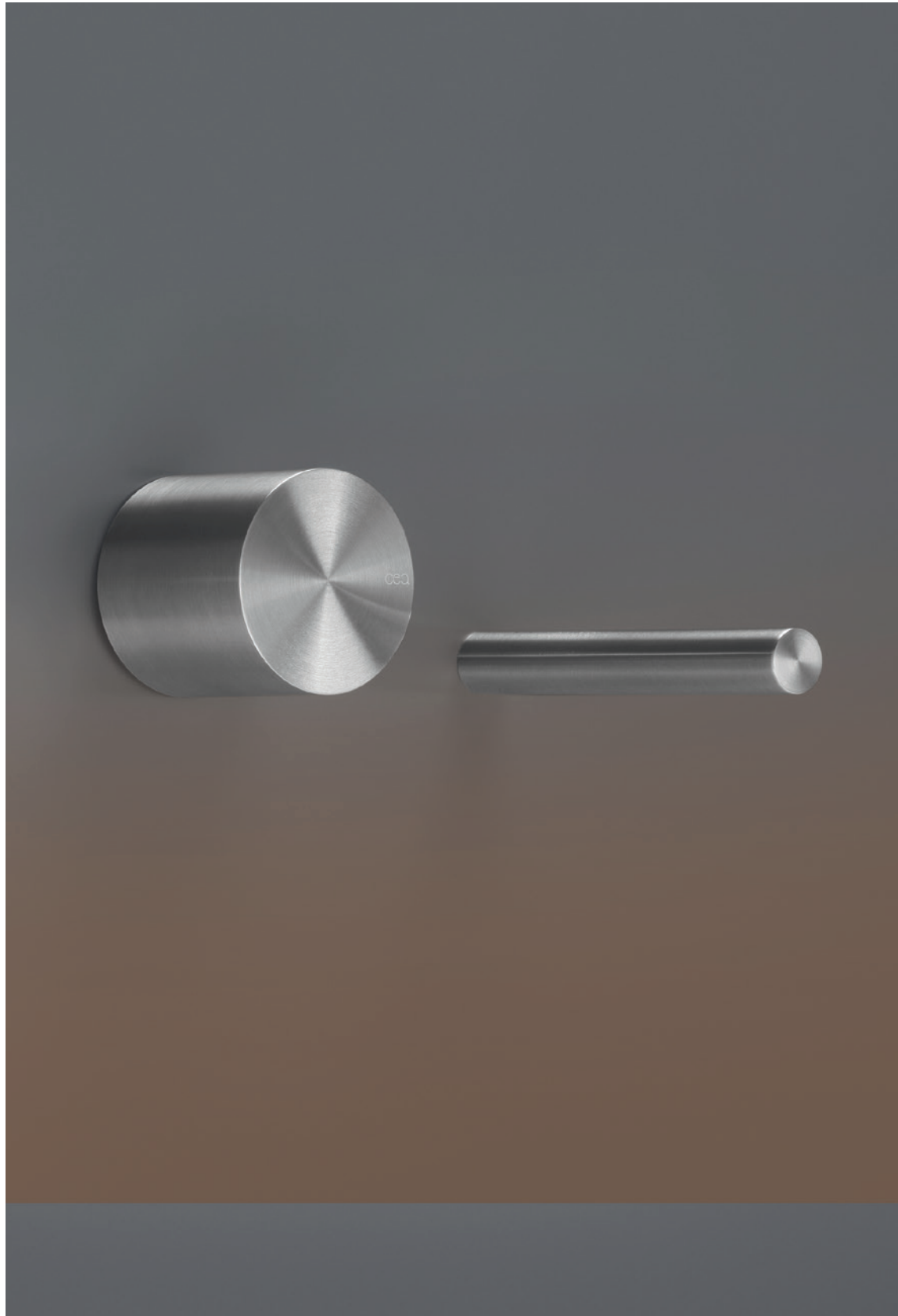

OPS04S





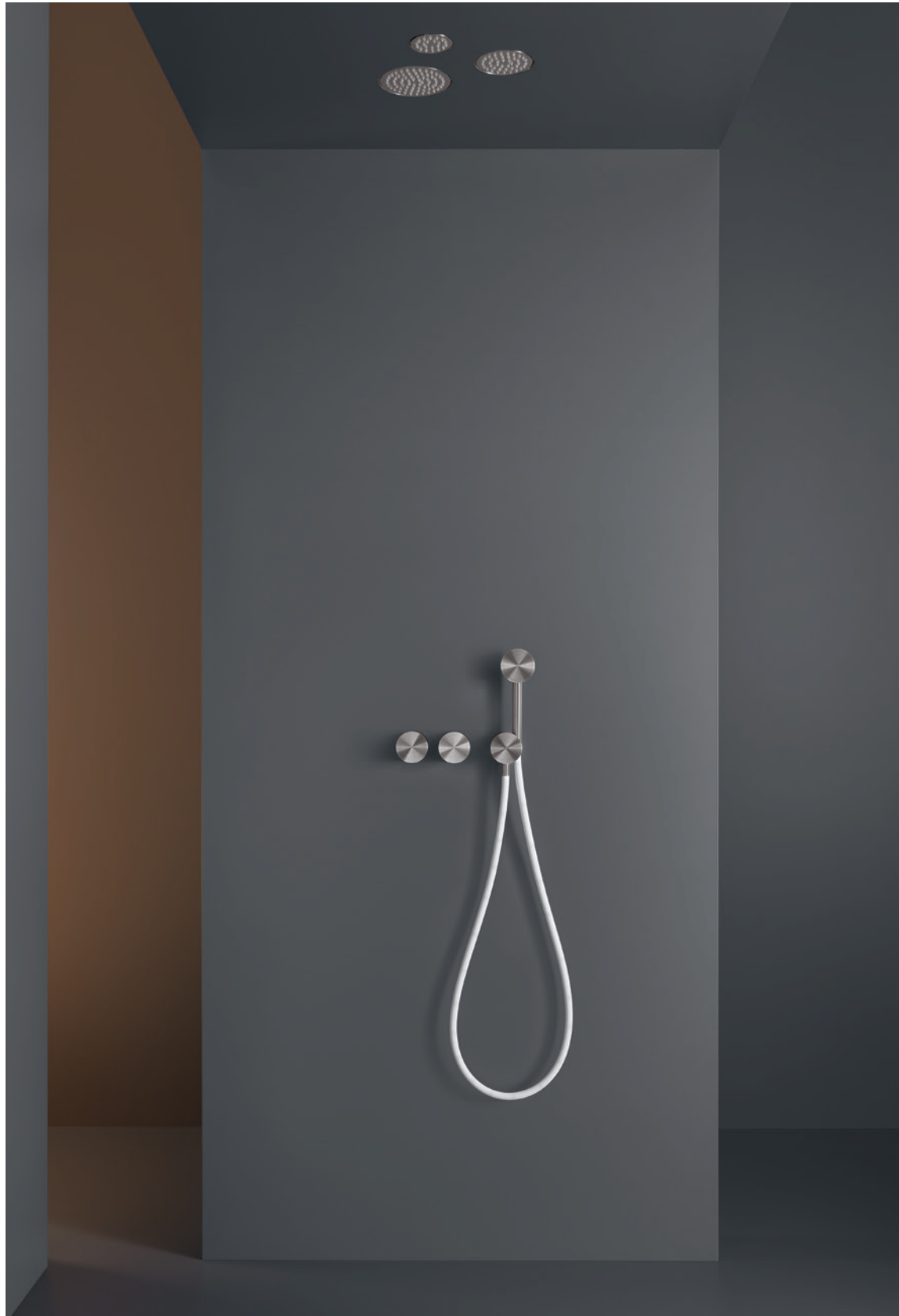

OPS24YWS + FRE129S

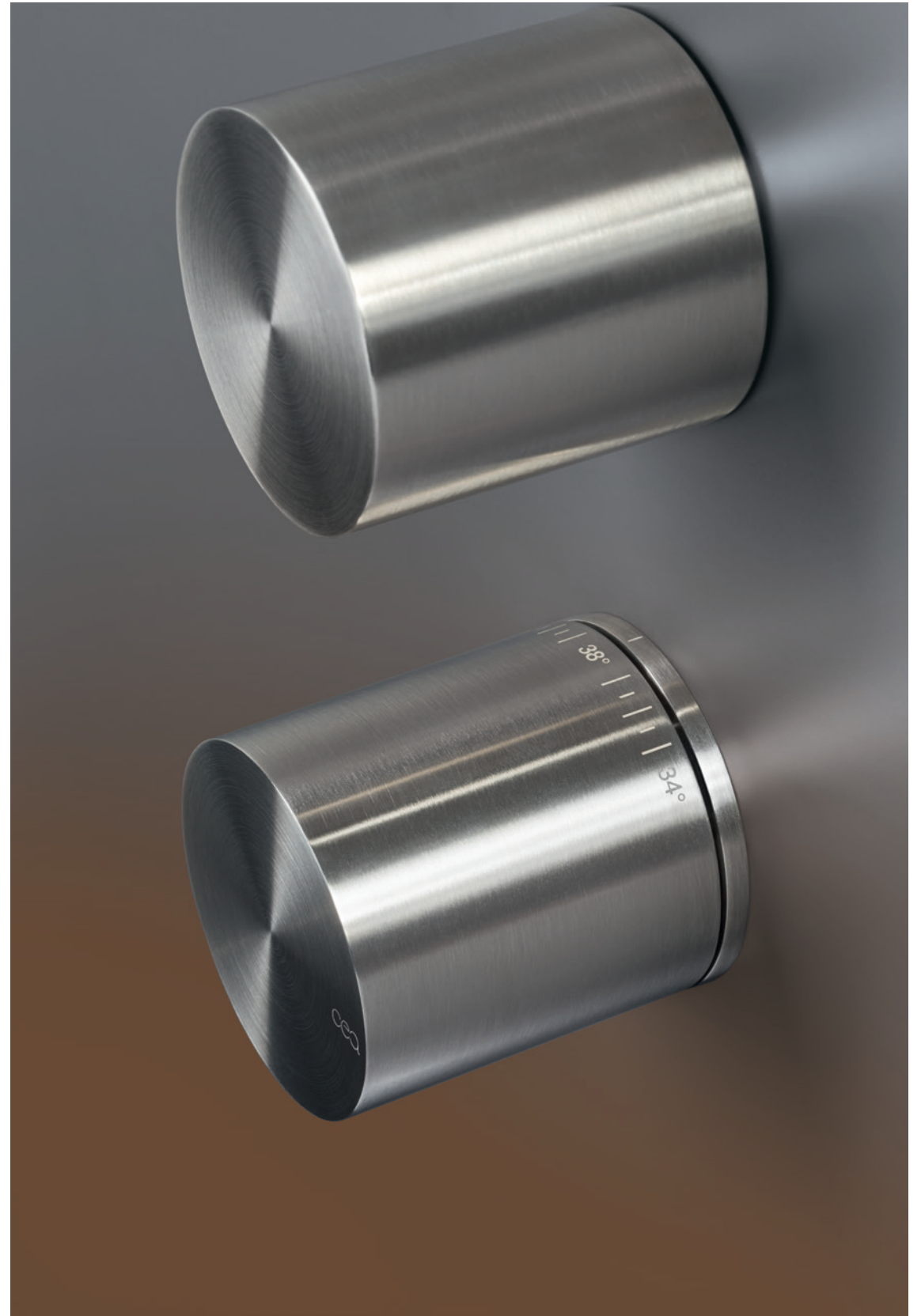

OPS51S

regolo

DESIGN EDOARDO GHERARDI





REG02S

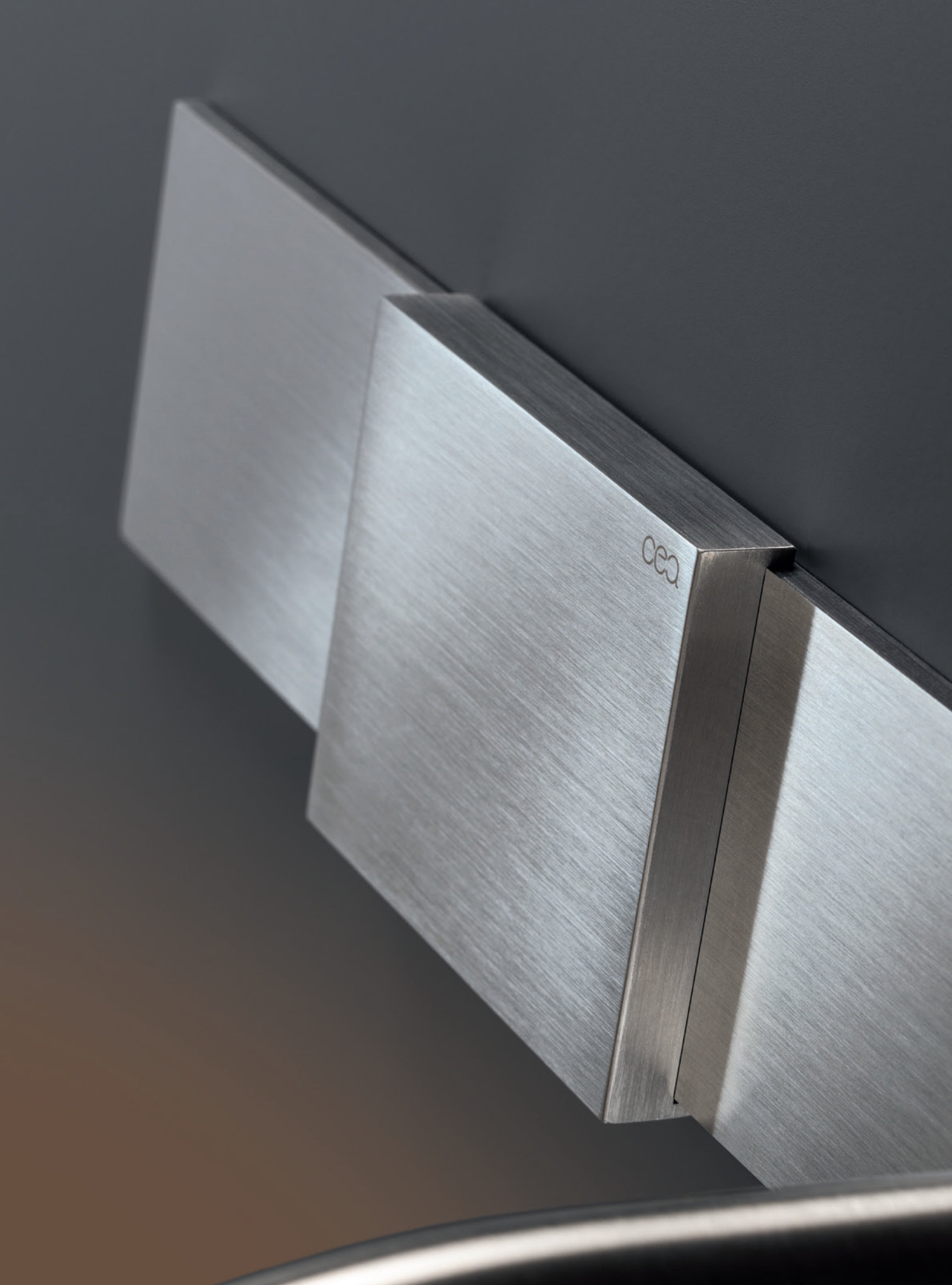

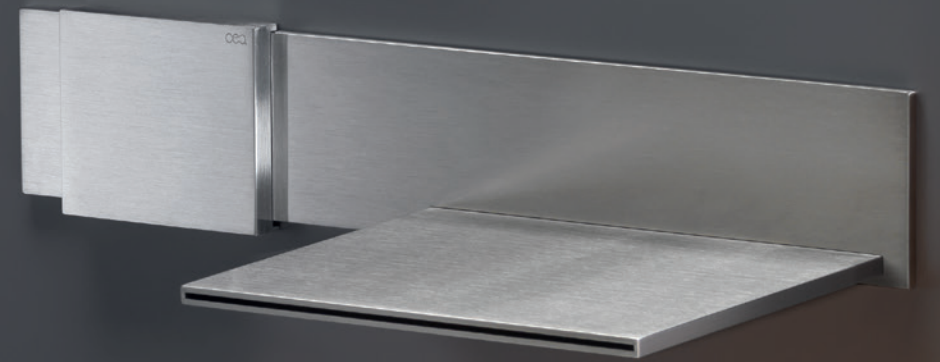



REG11WS + AQC42S



REG20WS



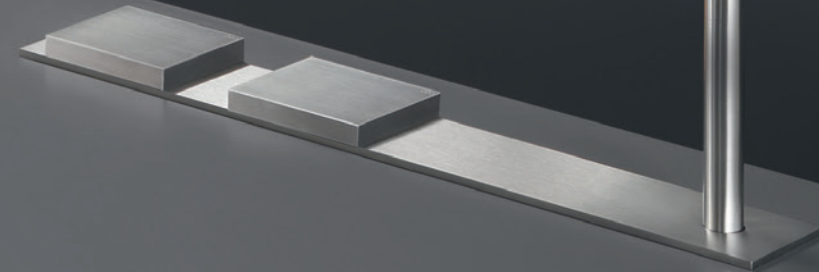
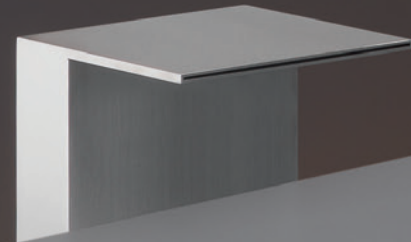

REG44S

REG13S



ziqq

DESIGN MARIO TESSAROLLO, DANIELA LORATO



ZIQ10S



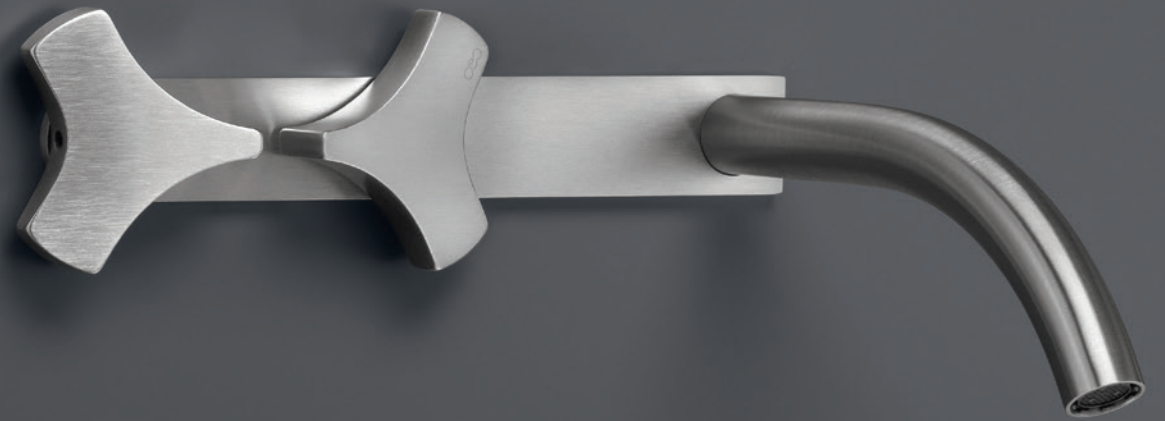





ZIQ39S





2 ZIQ18S + MIL90WS + ZIQ53S



ZIQ44WS



ZIQ68S POS05S

ZIQ66S

DOS01S

ZIQ61S

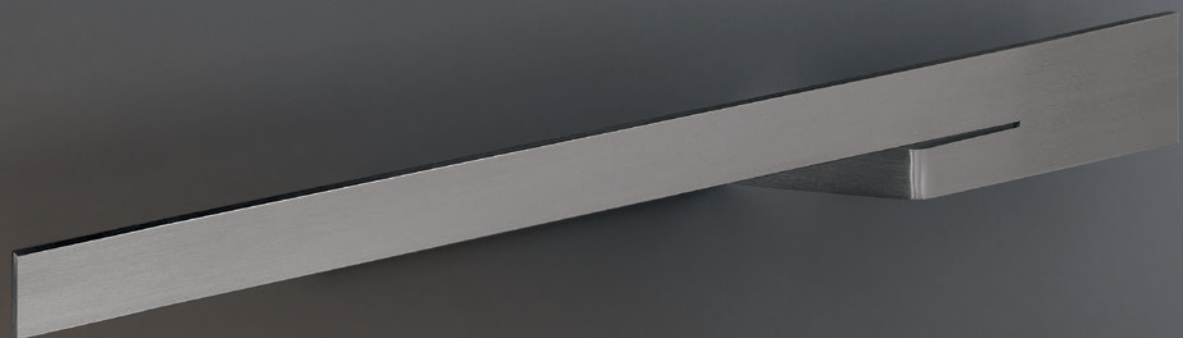

ZIQ61S



ZIQ66S

bar

DESIGN NATALINO MALASORTI





BAR29S



BAR31S

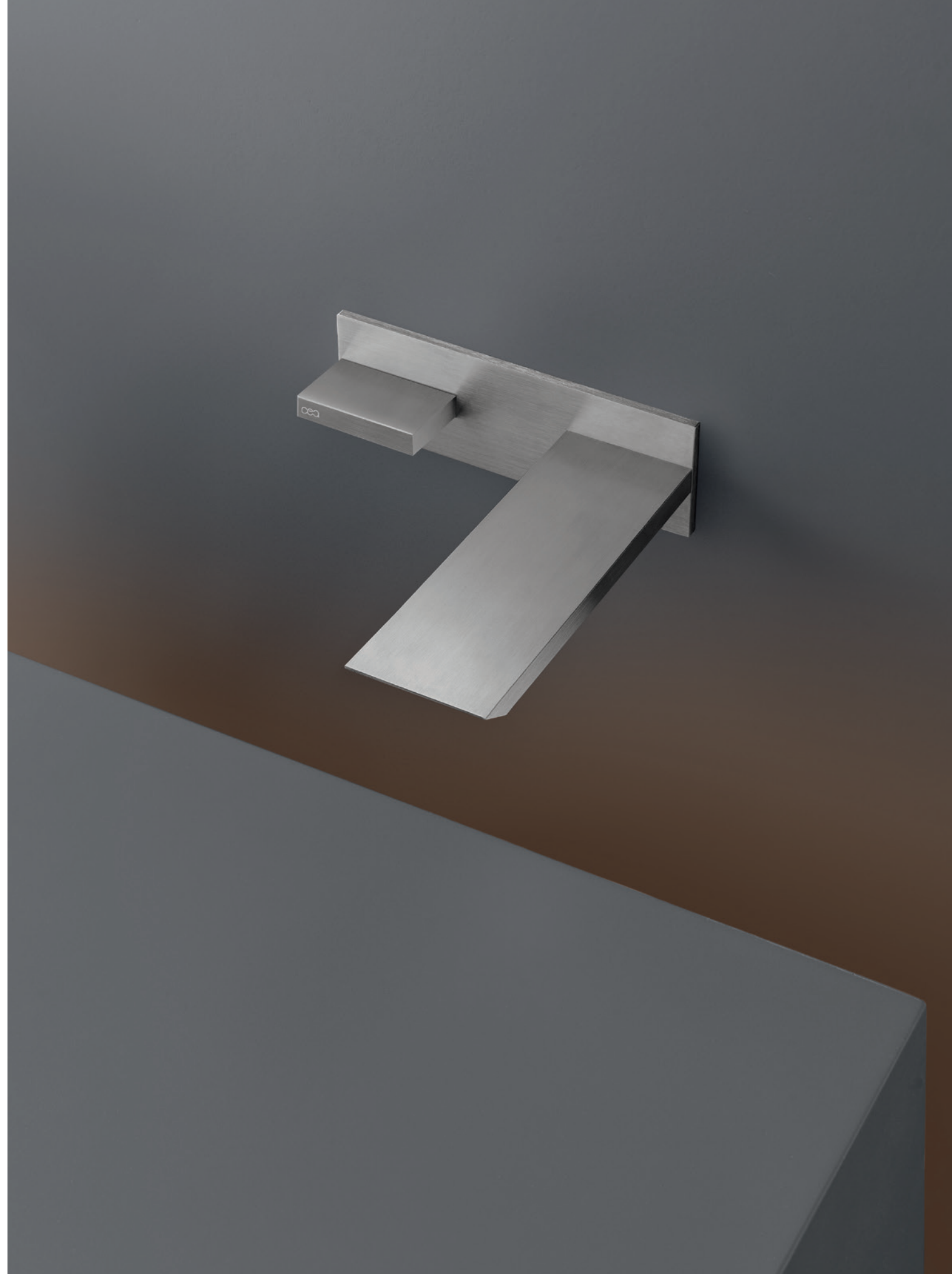





2 BAR50S + SWI07WS



ZIQ52S



BAR41WS



BAR37S



asta

DESIGN ROMANO ADOLINI

AST02WS





AST08S + AST09WS





AST10WS + AST08S







2 AST08S + FLX06WS + AST26WS



AST26WS

neutra

DESIGN GIULIO GIANTURCO

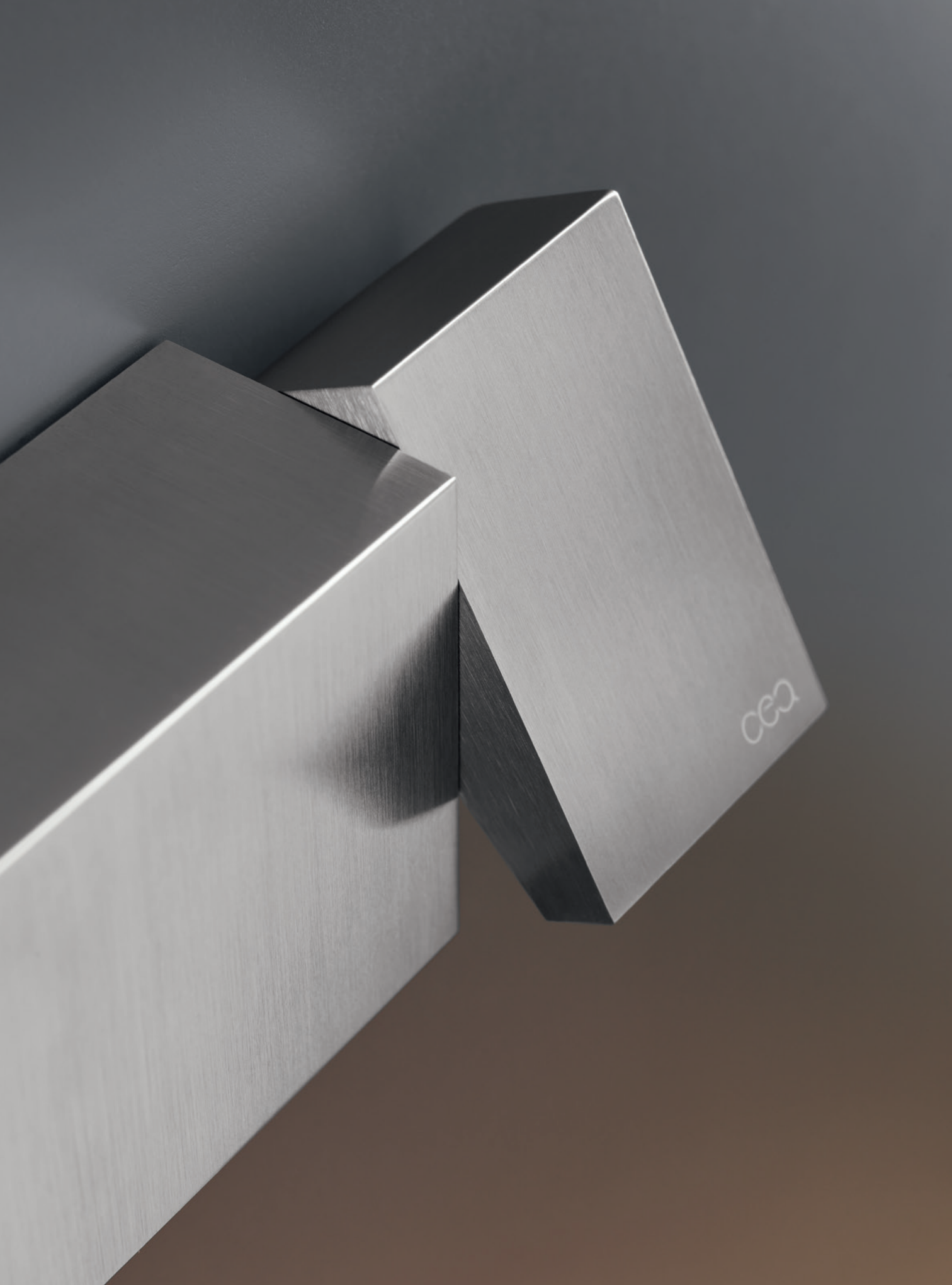

NEU04S + BAR55S



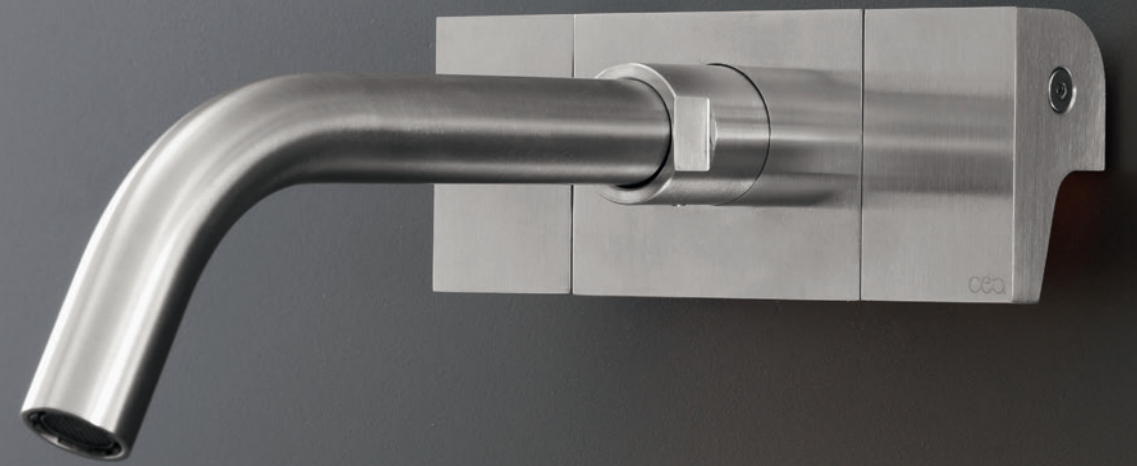





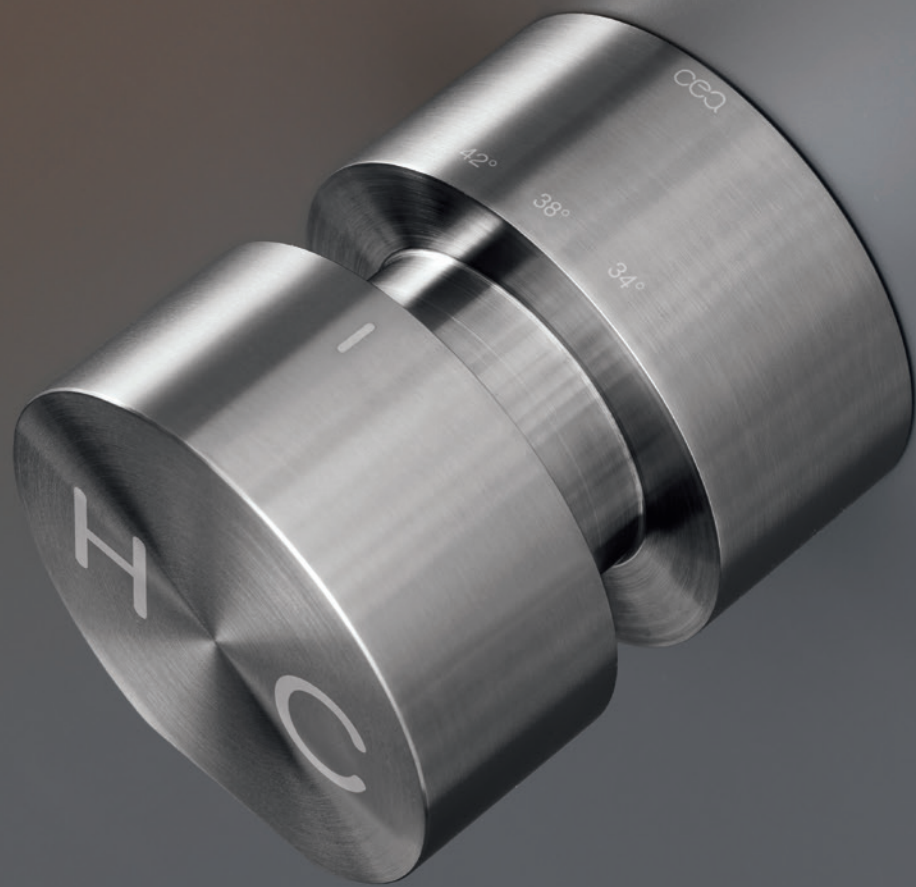

NEU38S + MIL90WS

NEU33S + FRE41S

NEU03S + FRE233WS







NEU47S



NEU04S + NEU03S + NEU32GS



NEU08S

NEU12S

DOS03S

NEU10S

NEU85S

NEU43S



NEU06S / NEU07S / NEU08S

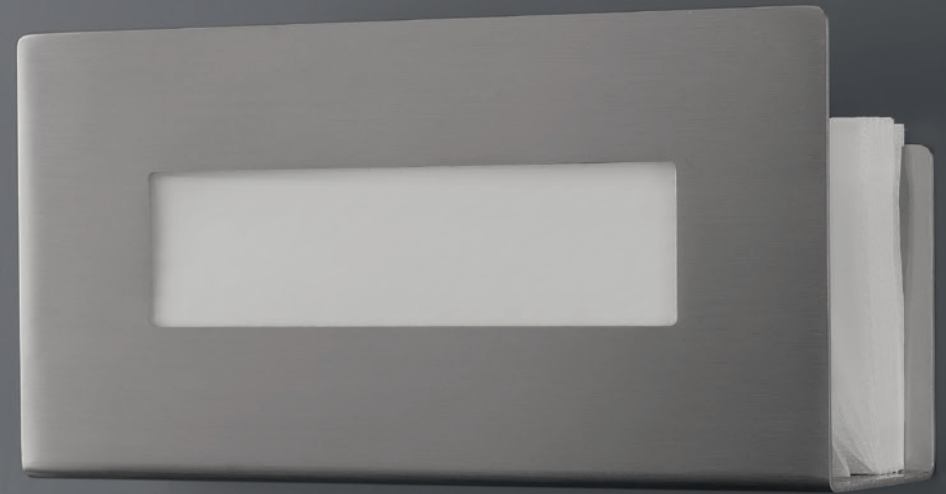

NEU12S



circle

DESIGN MASSIMO BROGLIO

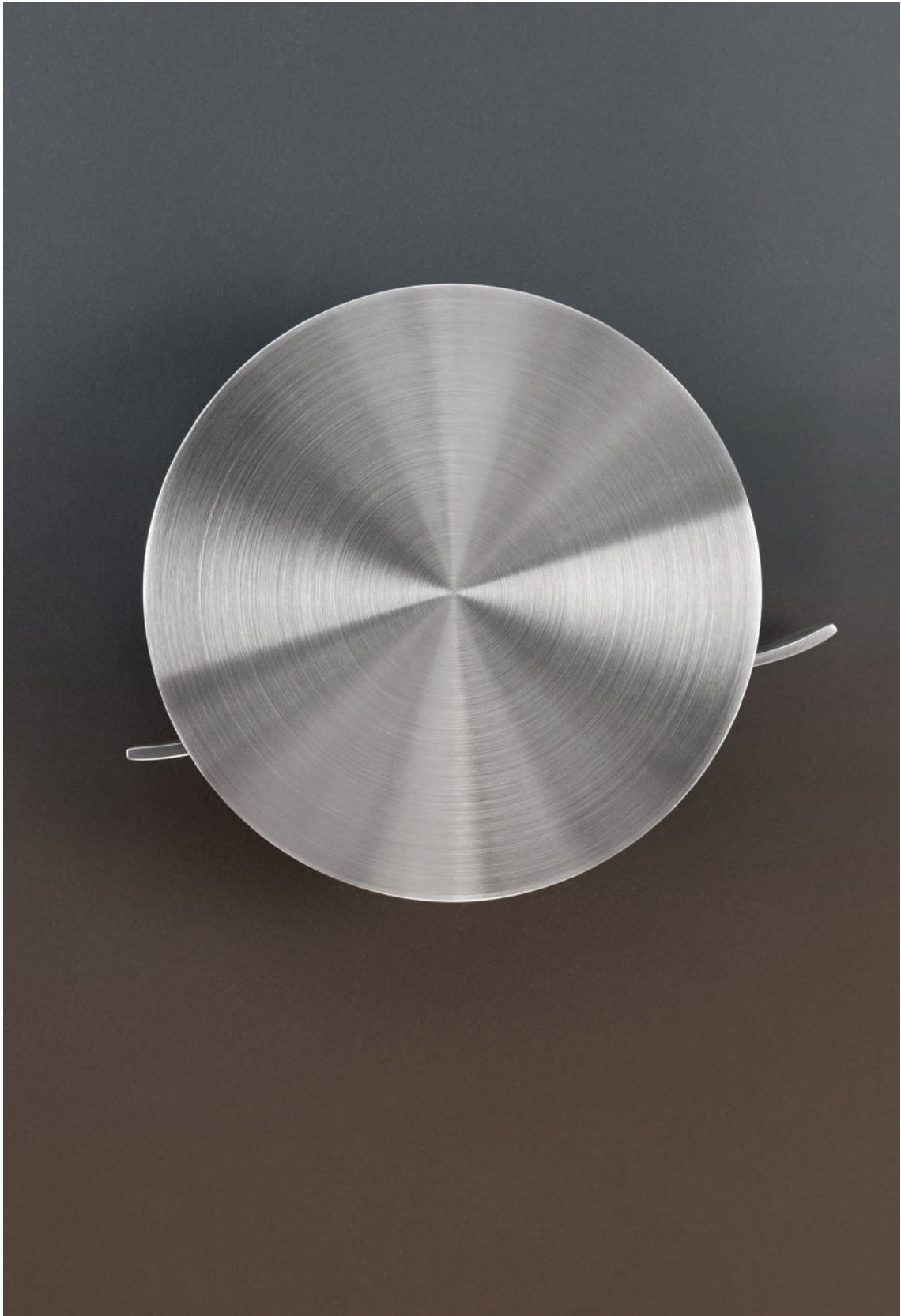

CIR05S



FRE197S + CIR05S

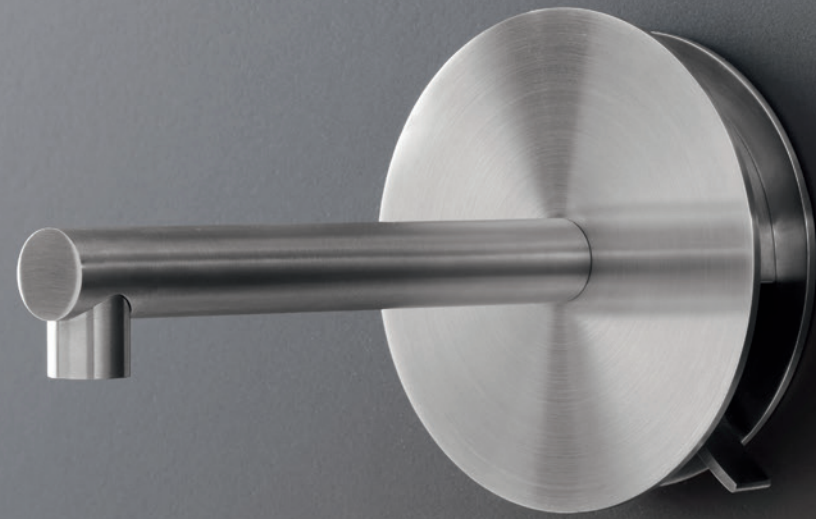





CIR09WS + FRE73S





CIR05S + CIR04WS + FRE41S





FRE10S



CIR05S + CIR07WS



gradi

DESIGN NATALINO MALASORTI



GRA11S + FRE06S





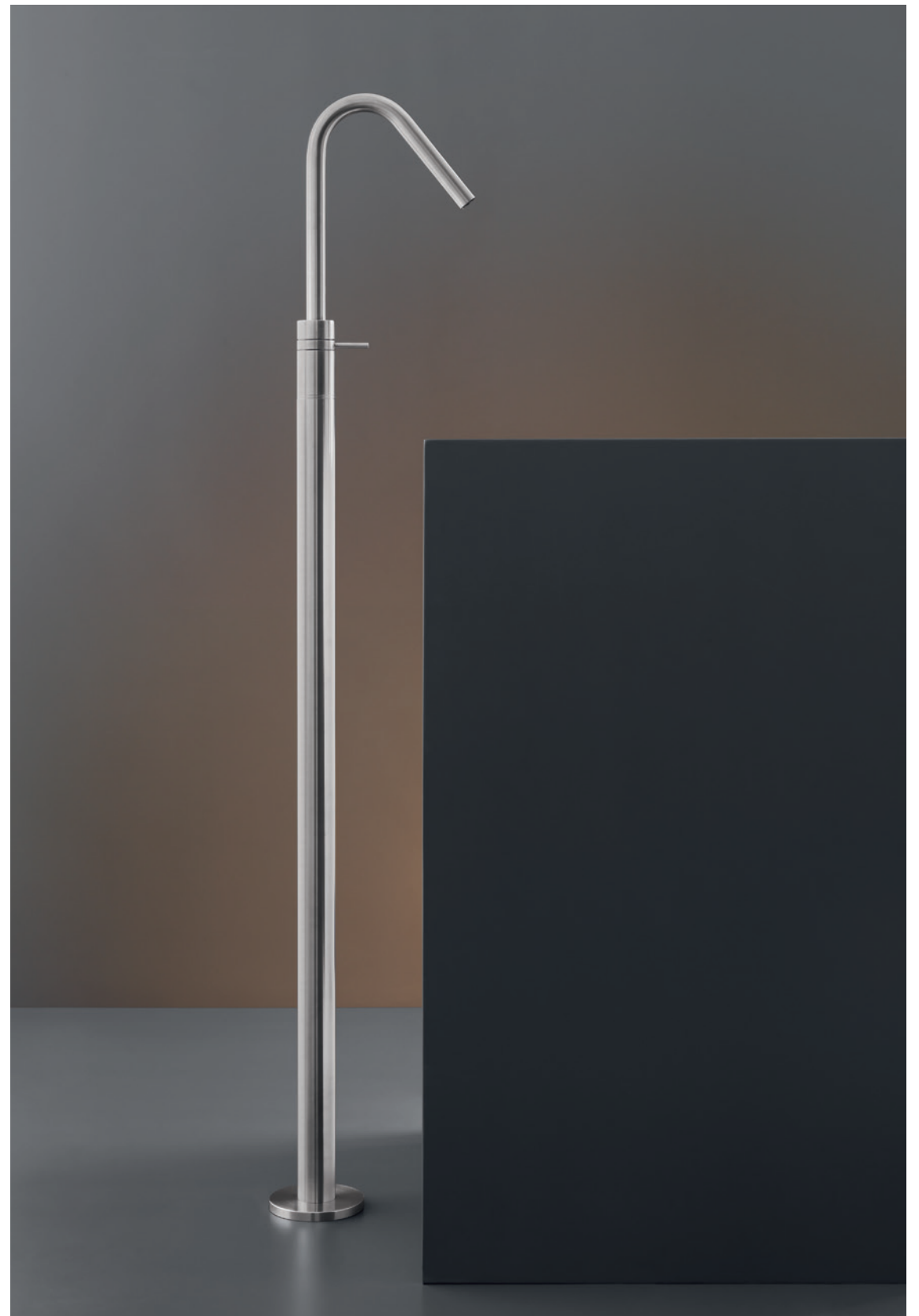

GRA12S

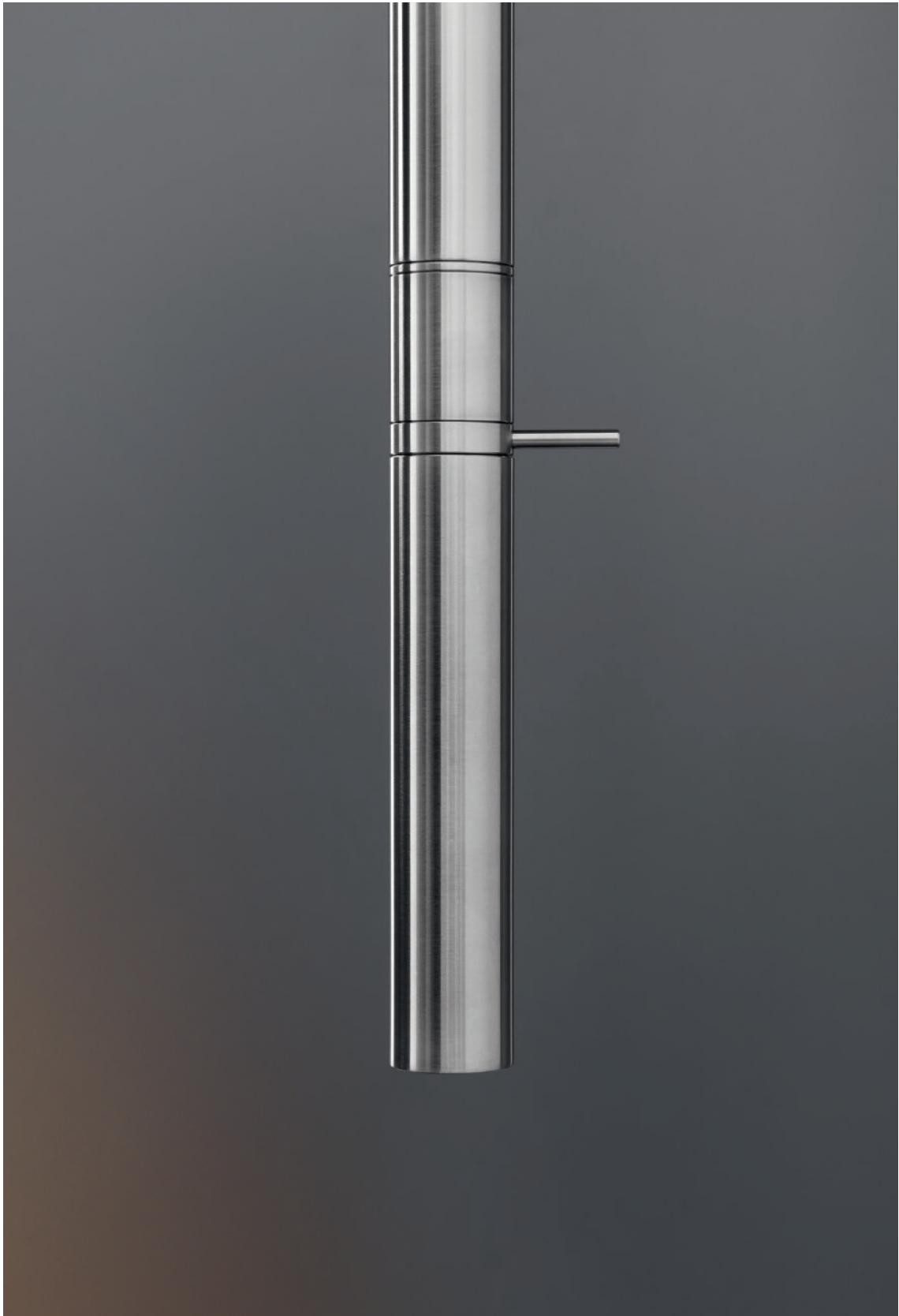

GRA19S





GRA14GS





GRA261S



**gastone**

DESIGN NATALINO MALASORTI



GAS05WS





GAS03WS



GAS11WS + FRE95WS + FRE74S



FRE95WS + FRE74S

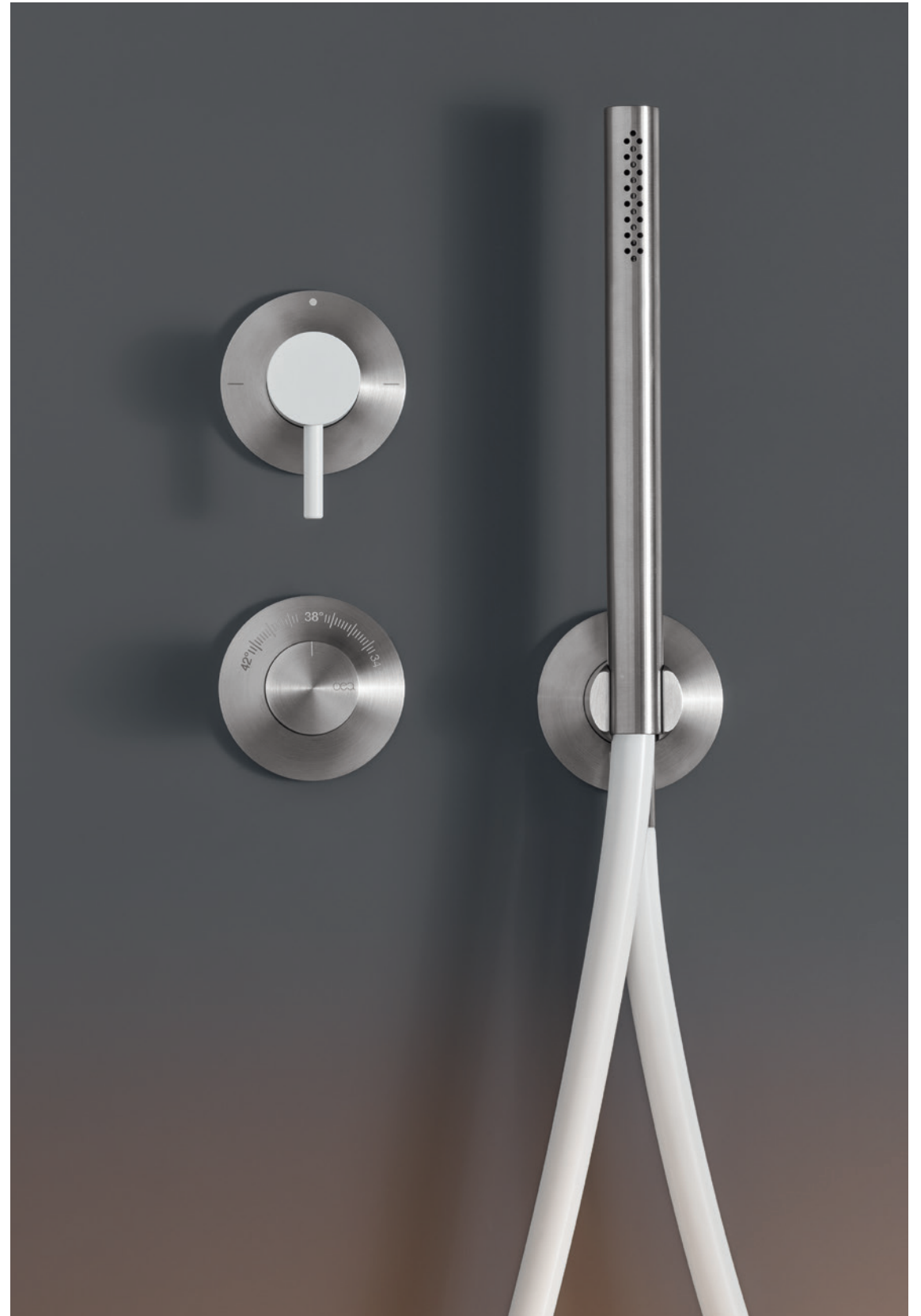



innovo

DESIGN NATALINO MALASORTI



FRE56S + INV80S



INV80S





INV01S



INV43S



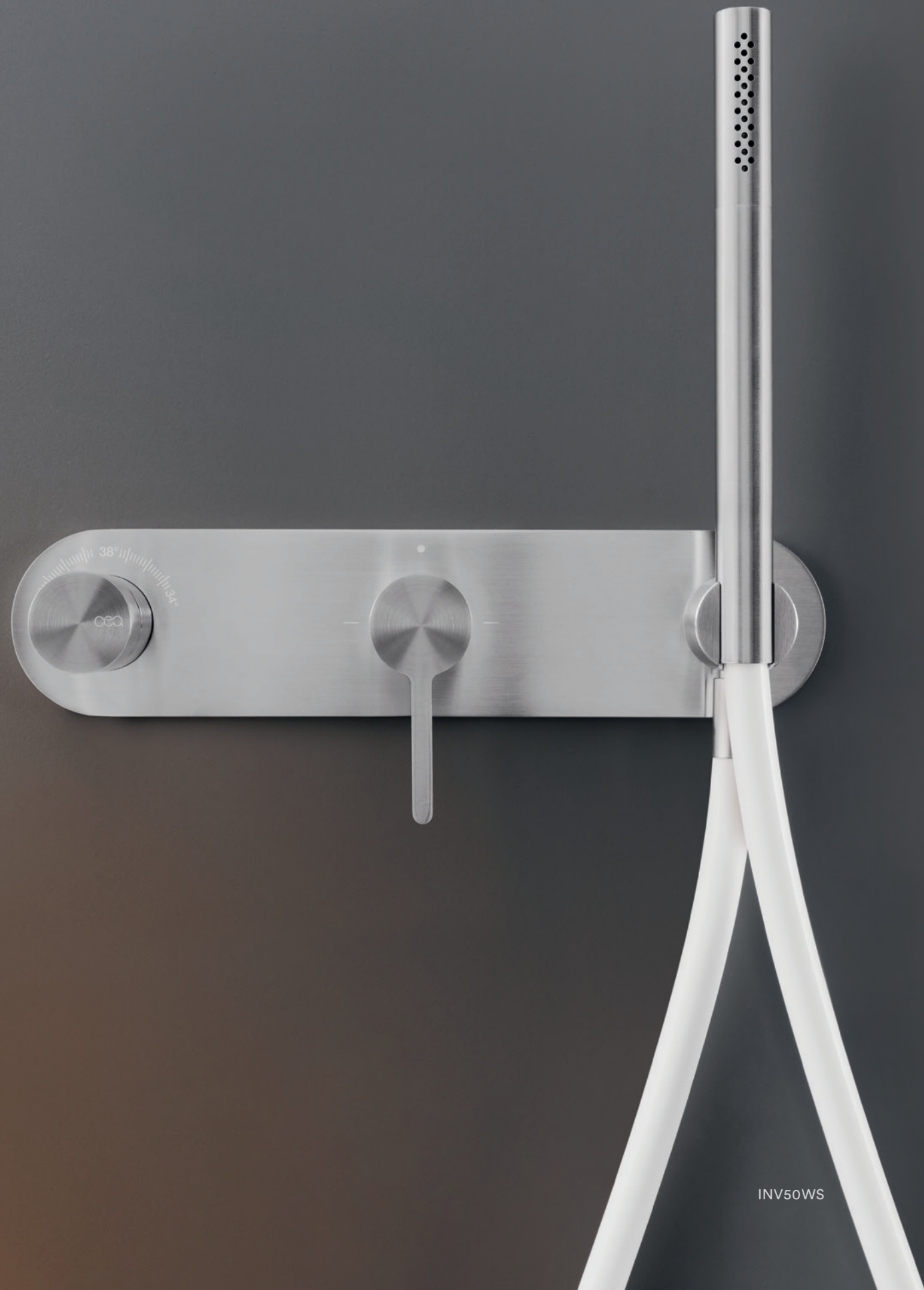

INV50WS



INV53WS + FRE12S + BRA07S

cartesio

CMP DESIGN



CAR24S



CAR09S



CAR04S







FRE168S



2 CAR15S + FRE17S + FRE34S



FRE179S



CAR21S + CAR54WS



CAR50WS + FRE41S

miLO360

CEADESIGN STUDIO



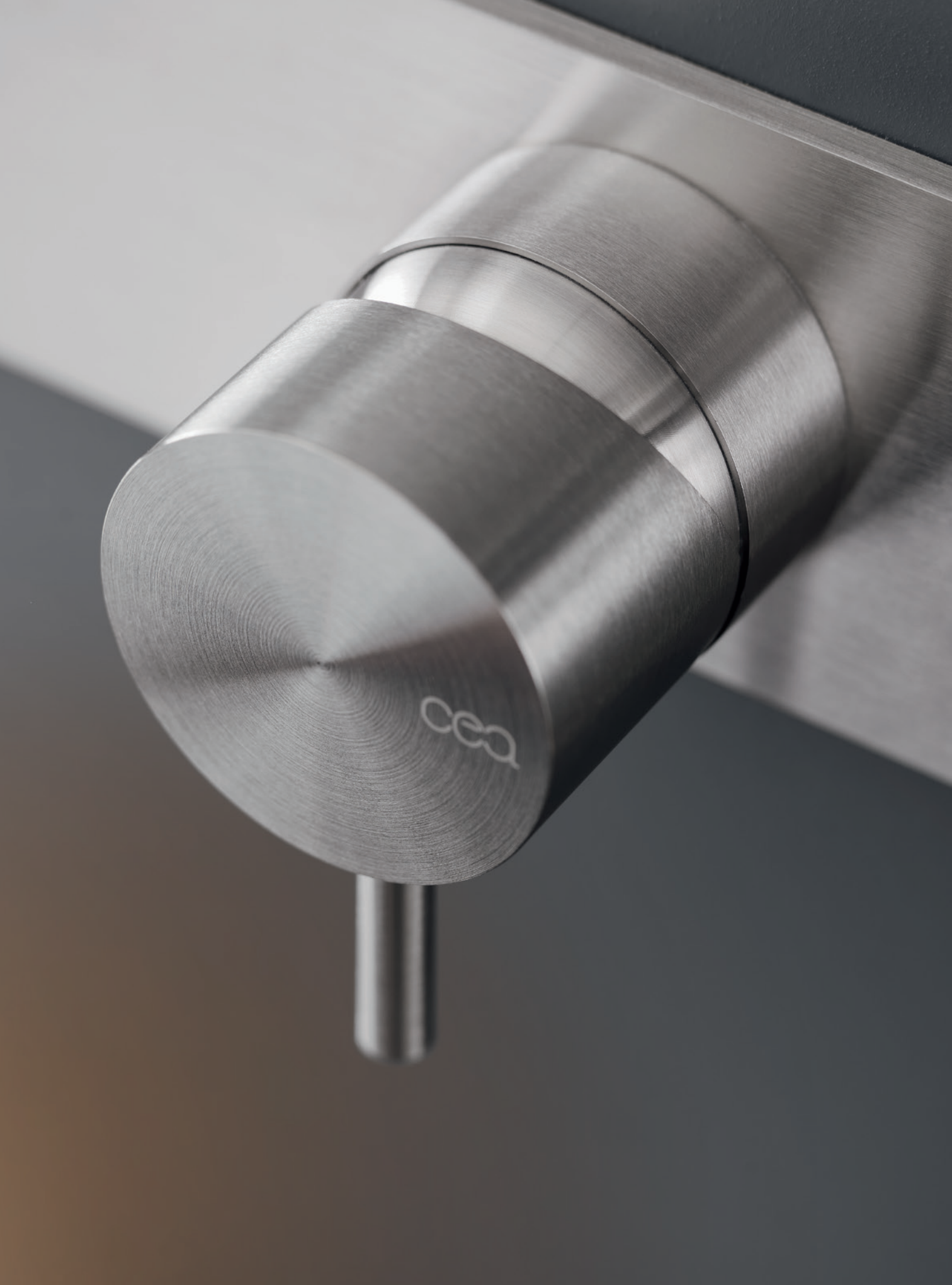

MIL04S



MIL78S

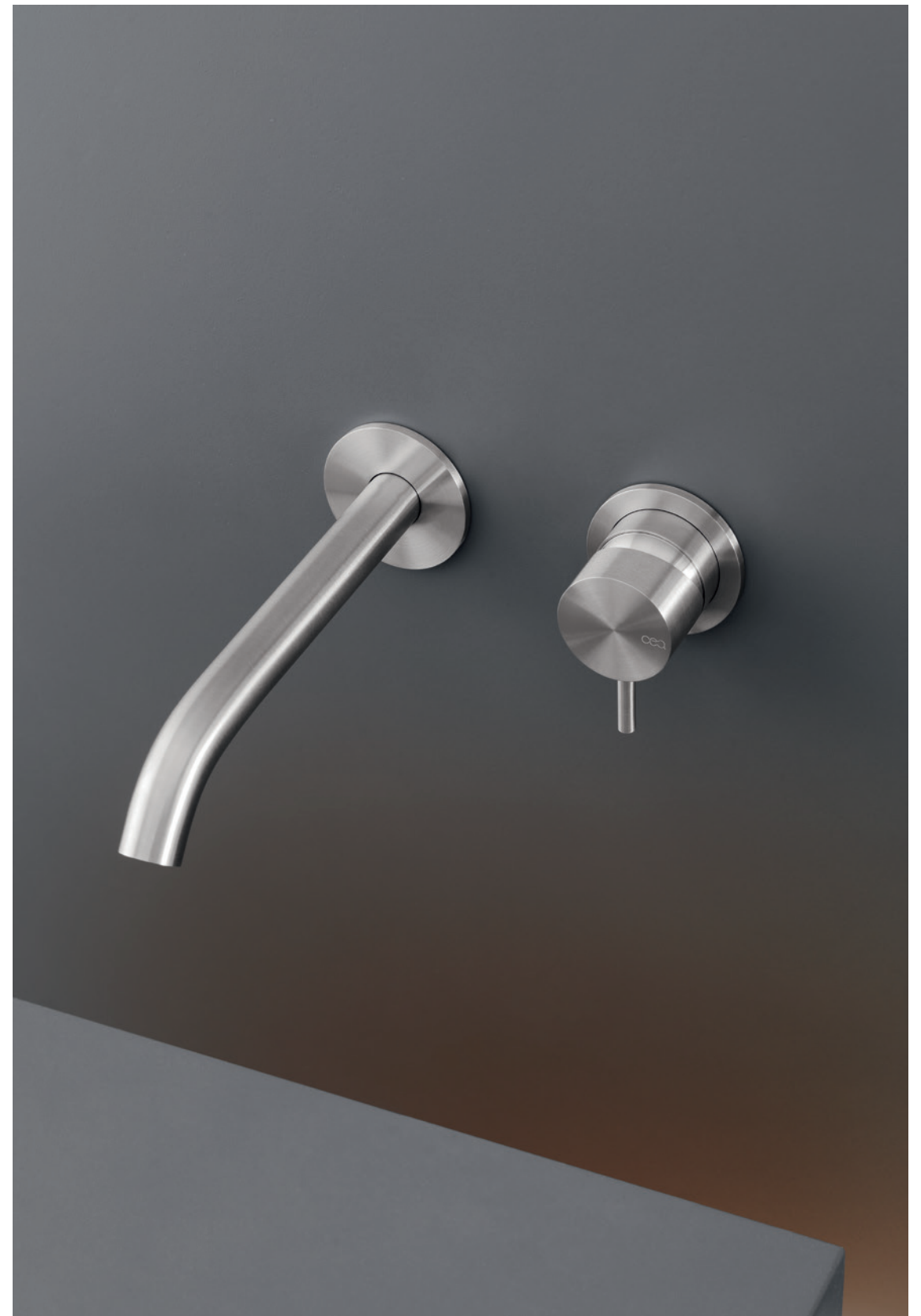

MIL35S







MIL95WS + DOS02S + 2 MIL91S







MIL19GS



MIL28S

# electronic taps

CEADESIGN STUDIO

MIL016S







MIL46S + IRS01S



MIL46S + IRS03S



MIL04RS

stem





MEN03S

MEN06S

STE08S

STE01S

PLA02S

POS01S

STE05S





STE01S

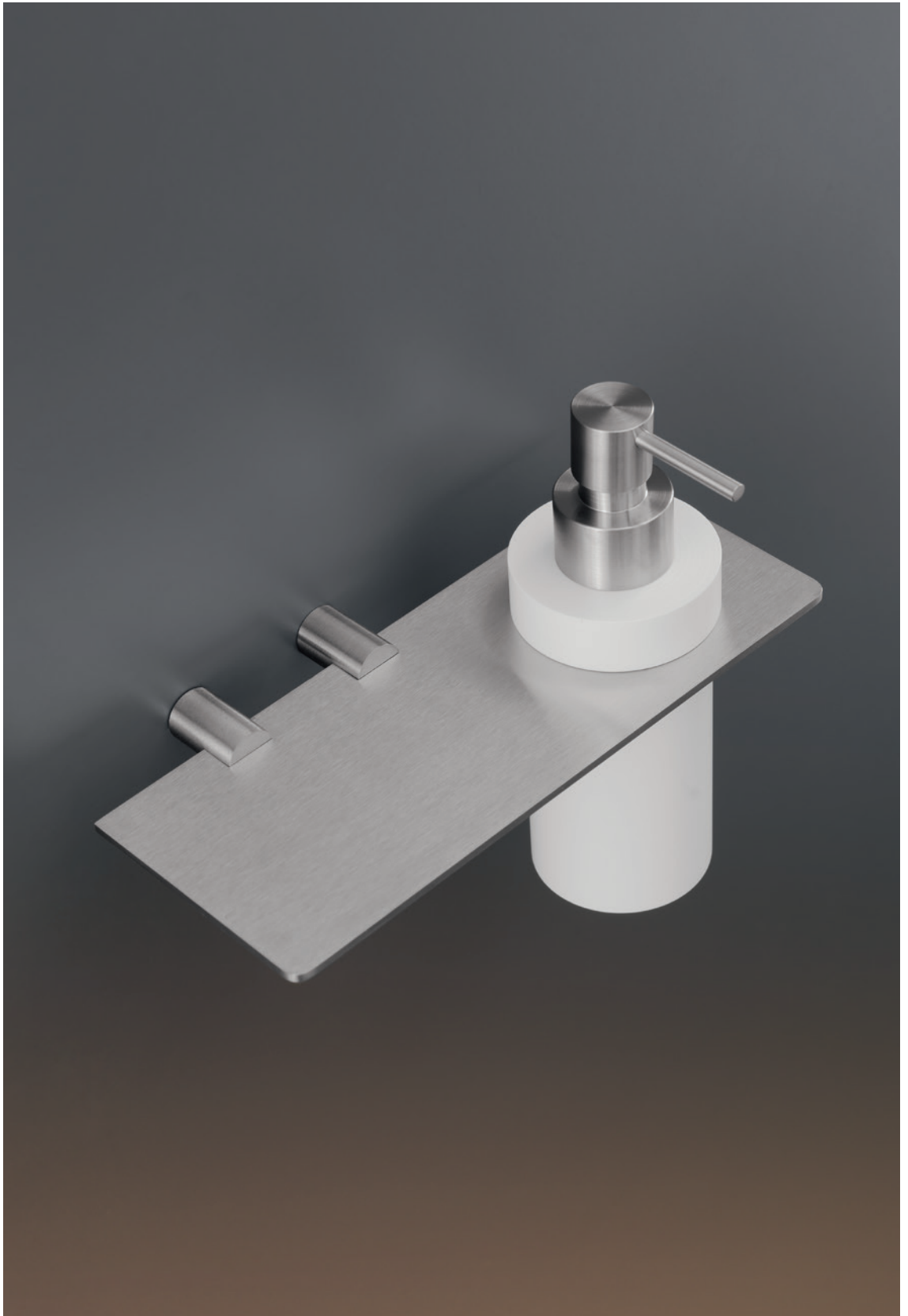

MEN06S

hydroplate

DESIGN NATALINO MALASORTI

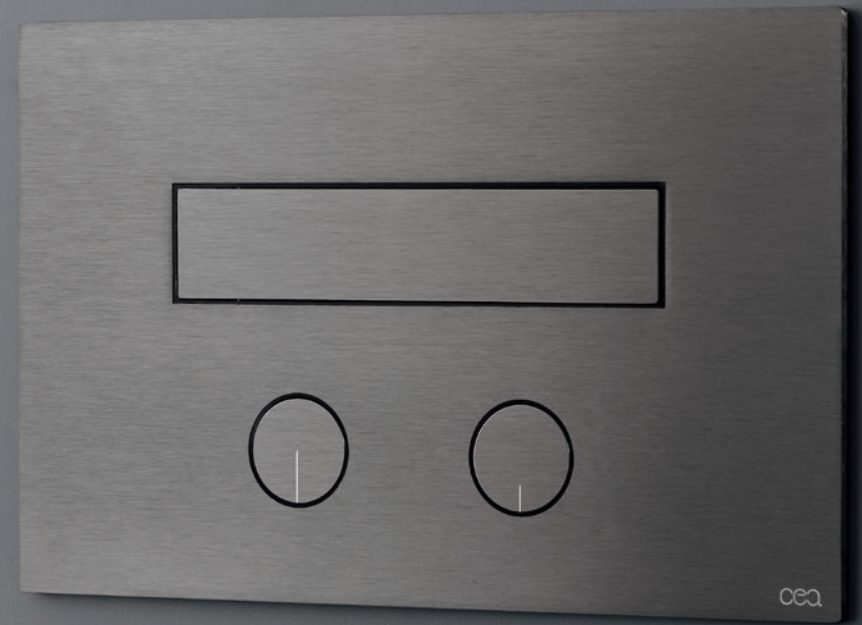



PLA02S





PLA07S



PLA06S









PLA11S



PLA10S





PLA22S



PLA23S





FRE44S



POR01S



FRE195S





FRE227IS



wellness





GIO56S + MIL90WS + FRE186S

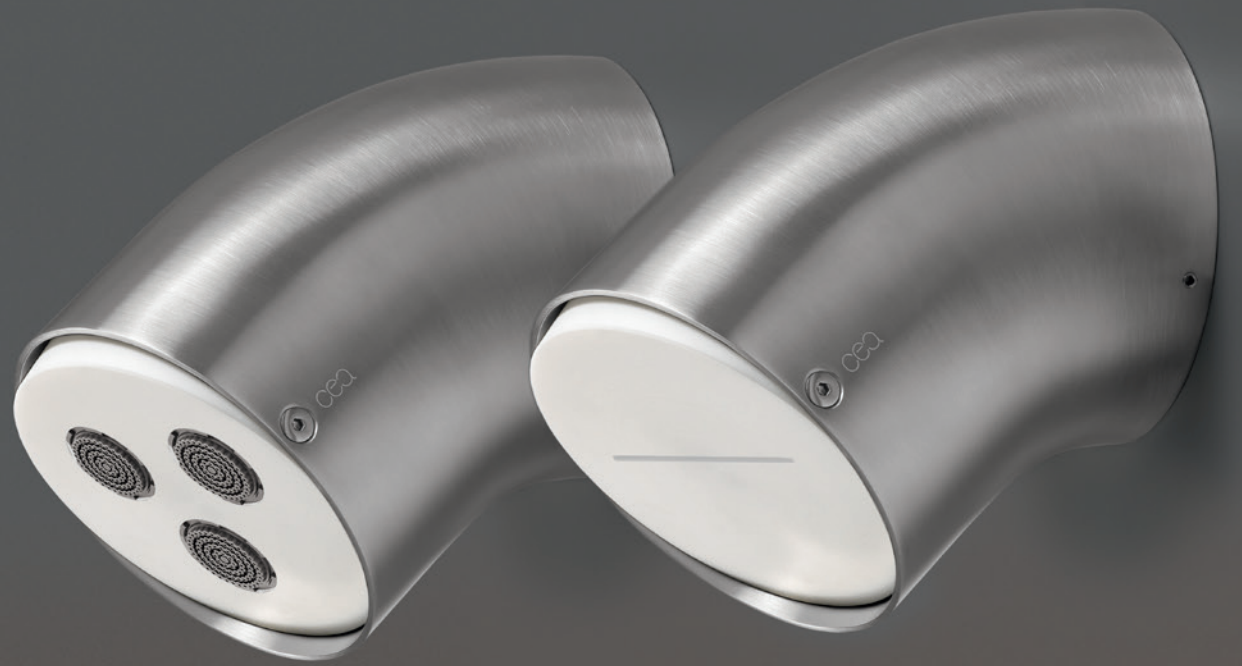

FRE186S



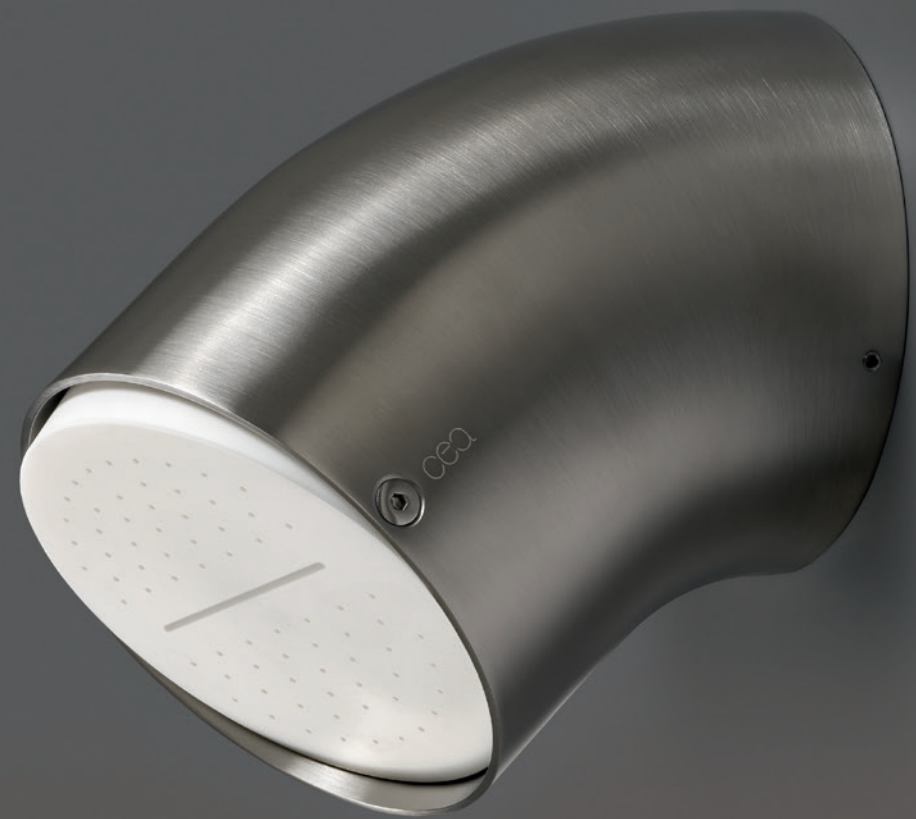



OPS50S + AQC40S + 6 FRE59S + OPS31S + FLX05WS



FLX05WS + OPS31S





FRE125S

FRE124S

FRE122S



FRE123S

FRE121S

FRE120S





FRE126S + FRE127S + FRE128S + FRE162S + 2 FRE164S



# equilibrio

DESIGN NATALINO MALASORTI



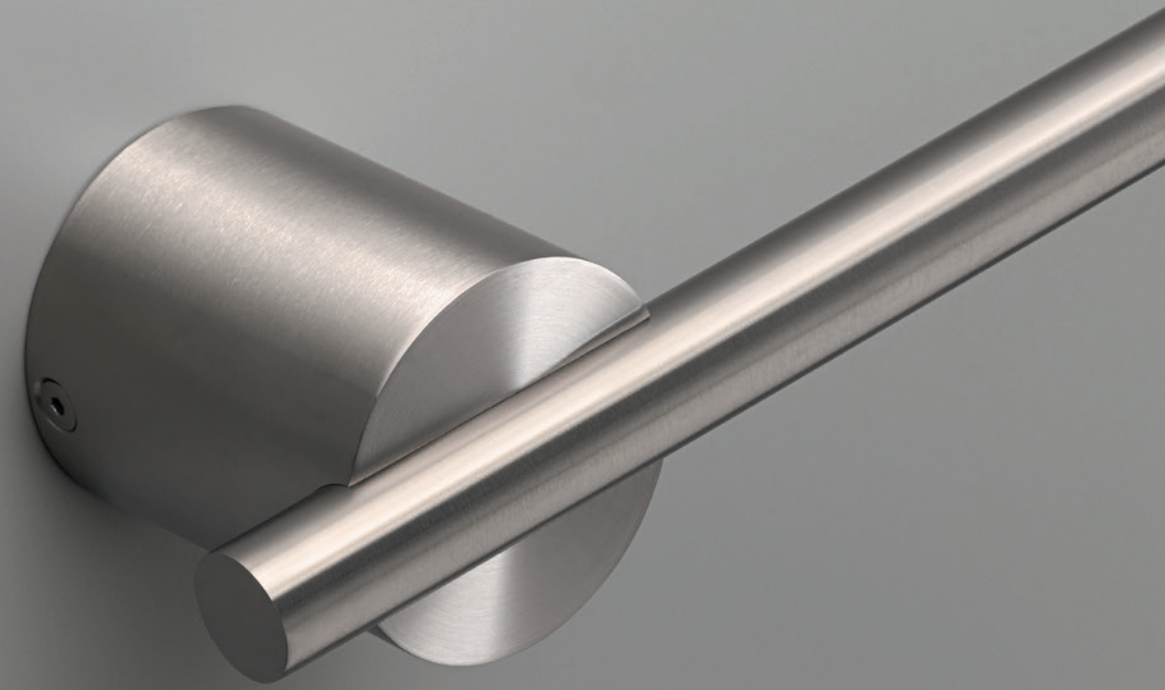



EQB13S





EQB44KDS







[www.ceadesign.it](http://www.ceadesign.it)

CEADESIGN srl s.u.  
Via Brenta 8  
36020 Pove del Grappa / VI / Italy  
T. +39 0424 572309  
[info@ceadesign.it](mailto:info@ceadesign.it)

CEADESIGN si riserva di apportare, senza preavviso, modifiche nei materiali, nelle finiture e nei disegni.  
Catalogo non destinato alla vendita.

CEADESIGN reserves the right to change, without previous notice, materials, finishes and drawings.  
Catalog not intended for sale.