

dyson airblade

The fastest, most hygienic hand dryers.



“It’s been seven years in the making but we’ve now achieved something quite revolutionary in motor design – one of the world’s smallest fully-integrated 1600W motors.

It was just the starting point for our latest hand drying technology.”

James Dyson

Inventor

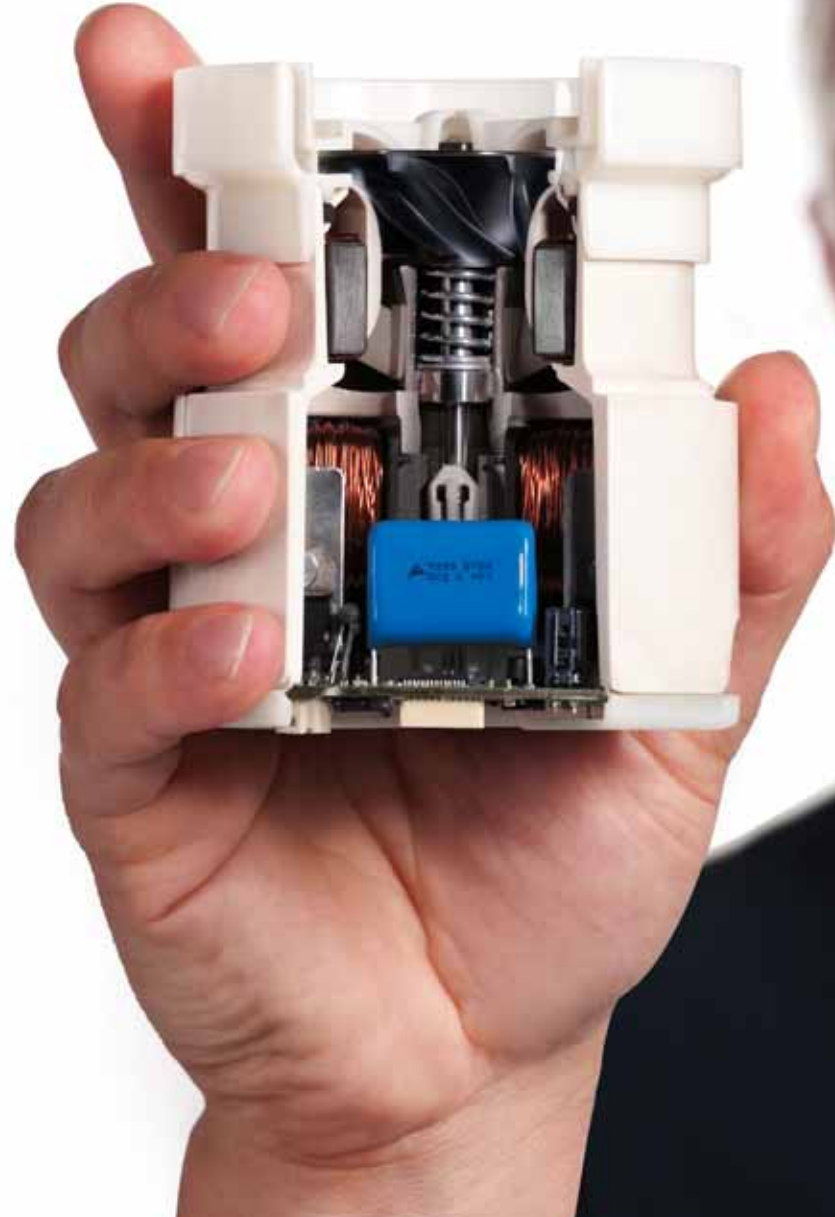

50% quieter.
Acoustically re-engineered
to reduce noise.

dyson airblade dB



Concentrated Airblade™
hand drying technology

dyson airblade V



Airblade™ hand drying
technology in a tap

dyson airblade tap



43 sec



10 sec



10 sec



12 sec



Other hand dryers are too slow

Testing based on NSF Protocol P335 shows that most other hand dryers are much slower than their manufacturers claim. Many people give up when using a slow hand dryer. But damp hands can spread up to 1,000 times more bacteria than dry hands.

Dyson hand dryers are the fastest
Testing based on NSF Protocol P335 proves that Dyson Airblade™ hand dryers are the fastest. Every second, up to 35 litres of air is forced through apertures up to 0.8 mm wide. The result – 430 mph sheets of air that scrape water from hands, drying them quickly and hygienically.

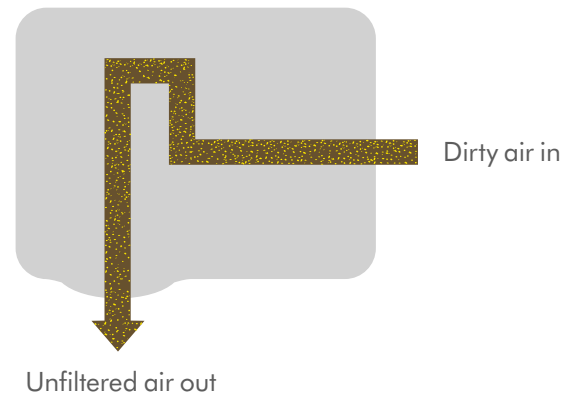

Other hand dryers are unhygienic

They don't filter bacteria from the washroom air. They suck in dirty air then blow it back onto hands.

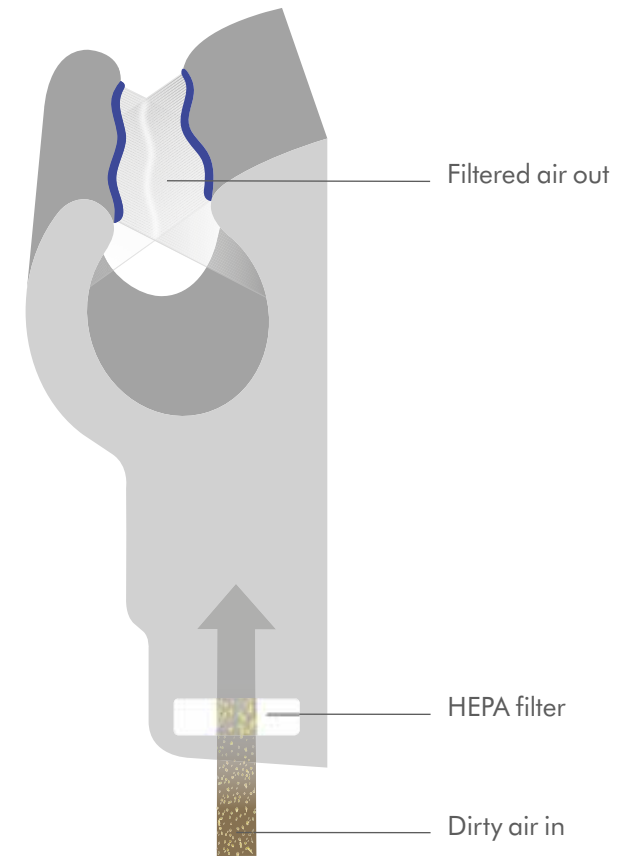

The most hygienic hand dryers Dyson Airblade™ hand dryers use HEPA filters. 99.9% of bacteria in the washroom air are captured. So hands are dried using cleaner air, not dirty air.

£1,460
per year



£157
per year



£40
per year



£43
per year



£48
per year



**Other hand drying methods
are expensive to run**

Paper towels need constant restocking and disposal. Most other hand dryers are slow so they're energy-hungry.

Low running costs
Dyson Airblade™ hand dryers cost up to 69% less to run than other hand dryers, and up to 97% less than paper towels.¹

¹ For calculations visit dysonairblade.co.uk/calcs

17.8g
CO₂ per dry



15.5g
CO₂ per dry



5.0g
CO₂ per dry



5.3g
CO₂ per dry



5.8g
CO₂ per dry



High impact on the environment

Dyson Airblade™ hand dryers produce up to 72% less CO₂ than some other hand dryers and up to 68% less than paper towels.¹

Low impact on the environment

Dyson Airblade™ hand dryers have a lower environmental impact across measures including carbon emissions and energy consumption.¹

¹ Based on LCA results of Dyson Airblade™ hand dryers calculated by Dyson using method developed in conjunction with Carbon Trust, and comparable results from T. Montalbo, J. Gregory, R. Kirchain. Life Cycle Assessment of Hand Drying Systems (a Dyson commissioned study 2011). Data taken from U.S. environmental statistics including electricity grid mix and recycling practices and relating to models AB02 and AB04.

Paper towels cause other problems

Blockages

Paper towels can clog waste water systems.

Overflowing bins

Soiled towels can end up on the floor of busy washrooms.

Empty dispensers

Dispensers are often left empty leaving no way to dry hands.

Wasteful

Used paper towels are rarely recycled, so they end up in landfill or are incinerated.

Create mess

Paper towels are often discarded without care. This can create a negative impression of washroom cleanliness.



dyson airblade dB

50% quieter

Airblade™ technology combined with the Dyson digital motor V4 creates high speed sheets of air. The Dyson Airblade dB hand dryer is the fastest way to dry hands and is 50% quieter than the original Dyson Airblade™ hand dryer. It is suitable for all washrooms, particularly where sound levels are an important consideration.

How it works

- 1 Dirty washroom air is sucked in by the Dyson digital motor V4.
- 2 It passes through a HEPA filter, removing 99.9% of the bacteria.
- 3 The filtered air passes over the electronics, cooling them.
- 4 The air then reaches the motor, which channels it up and through the machine.
- 5 Air passes into the air ducts which are insulated to reduce noise.
- 6 It's then forced through two apertures – creating sheets of air travelling at 430 mph.
- 7 The two sheets of air literally scrape water from hands.





Quieter and slower

Some manufacturers make their machines quieter by reducing the power, so they can take even longer to dry hands.



Quieter and just as fast

The Dyson Airblade dB hand dryer is 50% quieter than the original Dyson Airblade™ hand dryer, but still dries hands in just 10 seconds.

Acoustically re-engineered to reduce noise

Dyson engineers focussed on reducing sound from two key sources:

Reduced air rush noise

With a sound power level of 82 dB(A), the Dyson Airblade dB hand dryer is 50% quieter than the original Dyson Airblade™ hand dryer.

Airblade™ technology results in air travelling at 430 mph through apertures measuring just 0.4 mm in width. Some noise is inevitable.

Dyson engineers have reduced the noise produced by the sheets of air by redesigning the shape of the apertures through which air is forced.

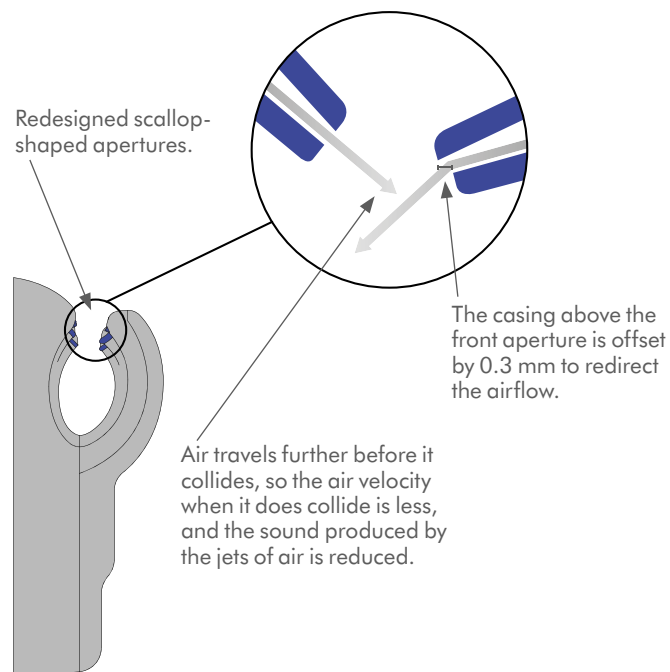

Reduced motor noise

Dyson acoustic engineers have made improvements to the level and quality of the sound generated by the Dyson digital motor V4.

The first and fourth harmonics of the motor tone, which are those most prominent to the human ear, have been isolated and substantially reduced. The high-pitch noise produced by the impeller has also been minimised.

Comparative noise level at frequencies unpleasant to the human ear

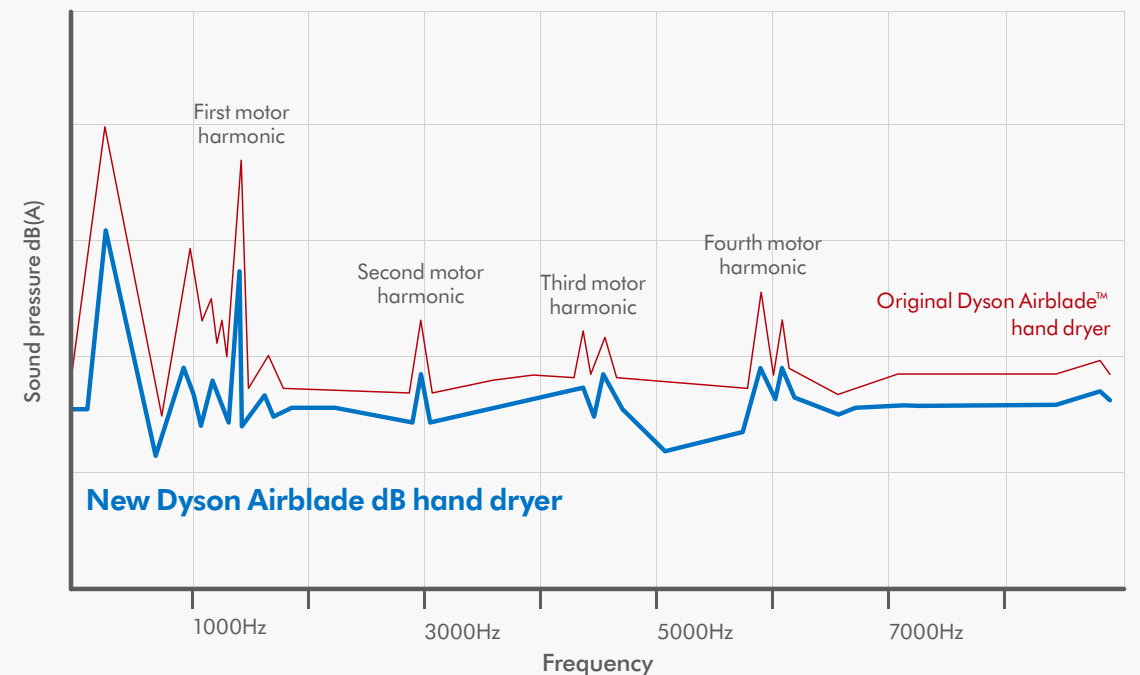

Graph has been simplified to aid communication

The most hygienic hand dryer

The Dyson Airblade dB hand dryer dries hands in just 10 seconds.

It's the fastest hand dryer. It also has touch-free operation, uses a HEPA filter and contains a lifetime antibacterial additive, which can help prevent the growth of bacteria.

Approved for use in food environments by HACCP



Test. Test. Test.

The Dyson Airblade dB hand dryer is engineered to last. It has been repeatedly tested for durability and resilience to physical and chemical abuse. It has also been exposed to real-life environments to ensure that it can withstand the pressures of high usage.

With strong construction and robust materials, the Dyson Airblade dB hand dryer is suitable for high footfall, high usage locations where vandalism can be an issue.

And because it uses 430 mph sheets of filtered air to dry hands, there is no heating element prone to wear and failure.



dyson airblade V

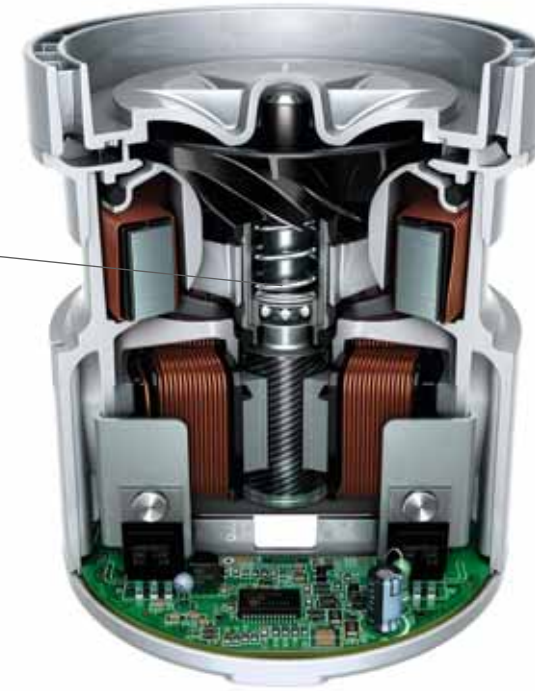

Concentrated, not compromised
Dyson engineers have developed one of the world's smallest 1600W motors, enabling them to build a hand dryer that protrudes just four inches from the wall. It dries hands hygienically, in 10 seconds.

The Dyson digital motor V4
The impeller spins 90,000 times a minute – generating enough power to draw in up to 35 litres of air per second. With fully-integrated mechanical, electrical and aerodynamic systems, it's a high efficiency, power-dense package with a diameter of just 85 mm.

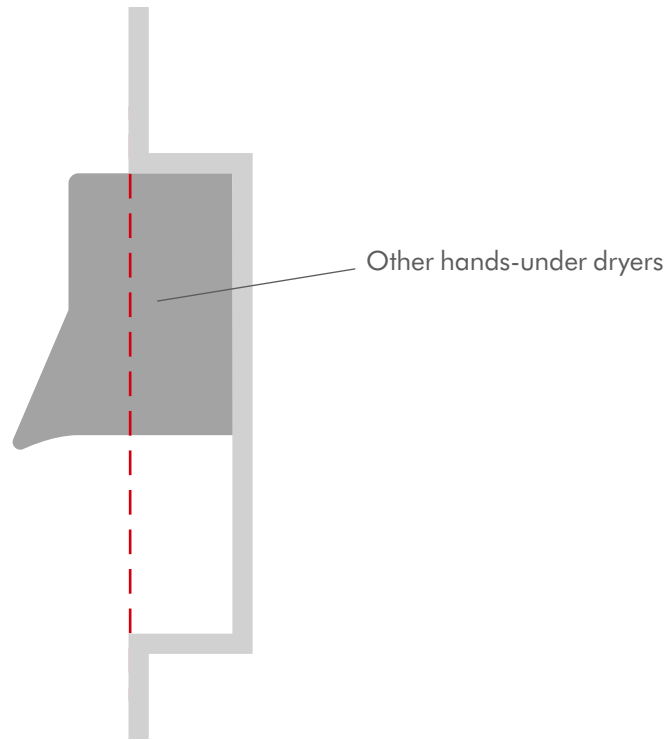

In the wall

Because of bulky motors, other hand dryers may protrude too far from the wall. They may have to be recessed into the wall. This can be costly.

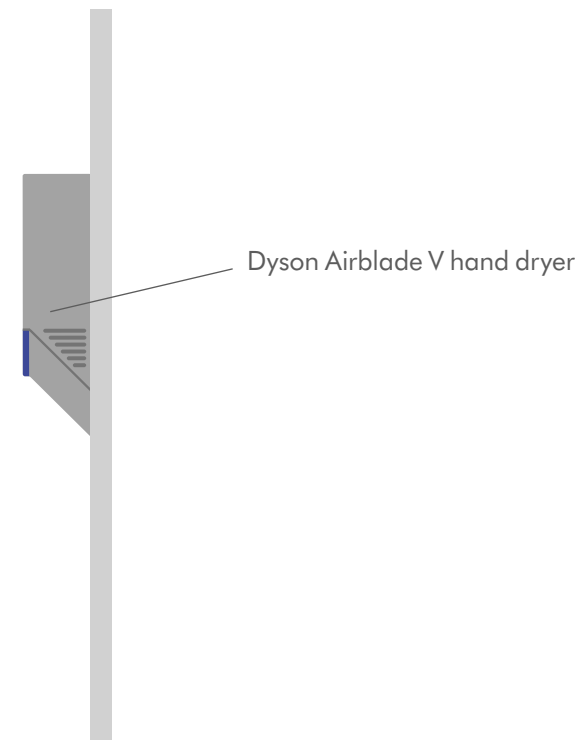

On the wall

The Dyson Airblade V hand dryer is just four inches deep, so it can be installed without recessing and the associated costs.

dyson airblade tap

Wash and dry hands at the sink
With Airblade™ technology in a tap, hands can be dried at the sink in 12 seconds. There's no need to move to a separate drying area.

How it works

Both water and air are sensor operated so there are no taps to turn, or buttons to touch. Intelligent infrared sensors emit light to pinpoint hand positions. Computer circuitry coordinates the information and initiates the appropriate response of water or air without long delays. It's been tested for 365,000 cycles, and is mains powered, so there are no batteries to run out.



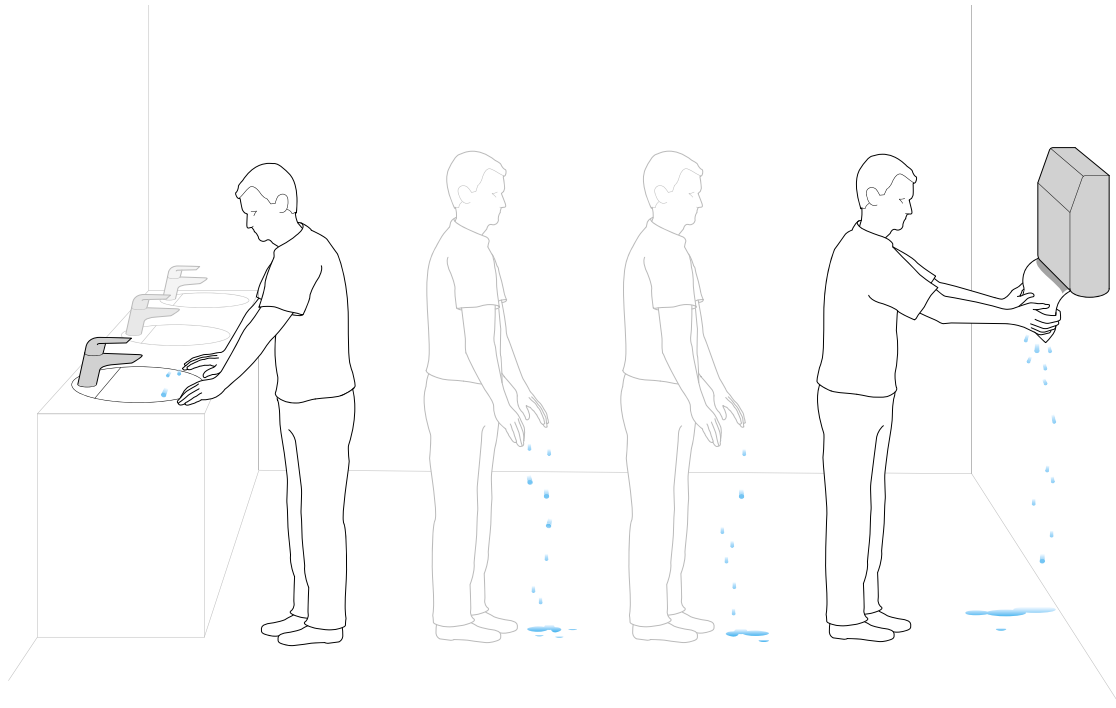

Water on the floor

Moving to a separate hand drying area with wet hands means water is often dripped on the floor. This can create problems in the washroom.

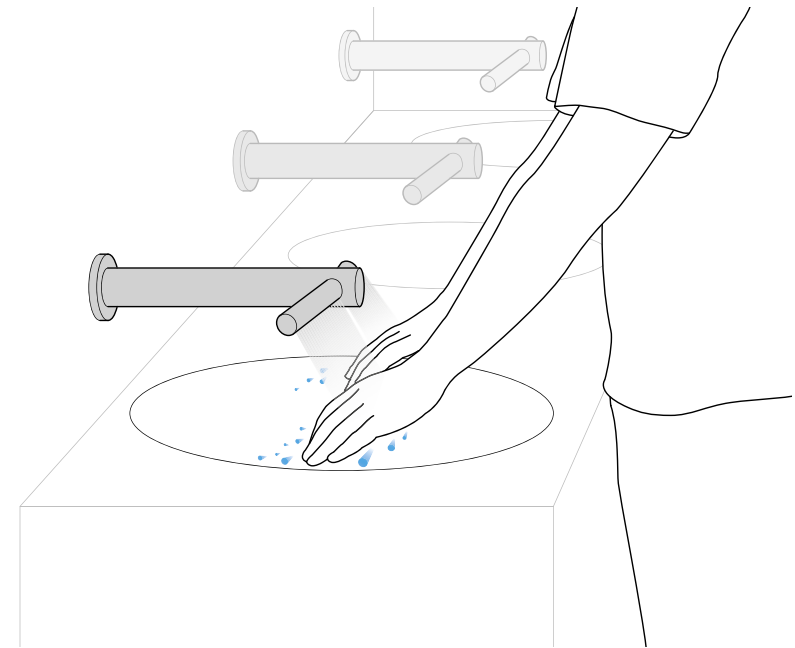

Water in the sink

With the Dyson Airblade Tap hand dryer water isn't dripped on the floor because you don't need to leave the sink with wet hands.

Inside the Dyson Airblade Tap hand dryer

Inside the tap

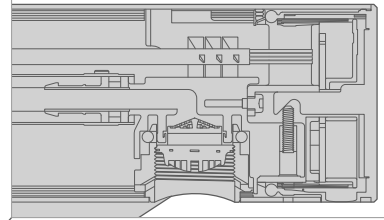

Laser welding

Fully-automated robotic precision cutting and welding allows high quality stainless steel tubes to be used in construction.

Airblade™ technology

Air travelling at 430 mph exits laser-cut air slots measuring just 0.8mm in width.

Intelligent water and air infrared sensors

Sensors auto-calibrate so that air and water are only activated when a hand is underneath.

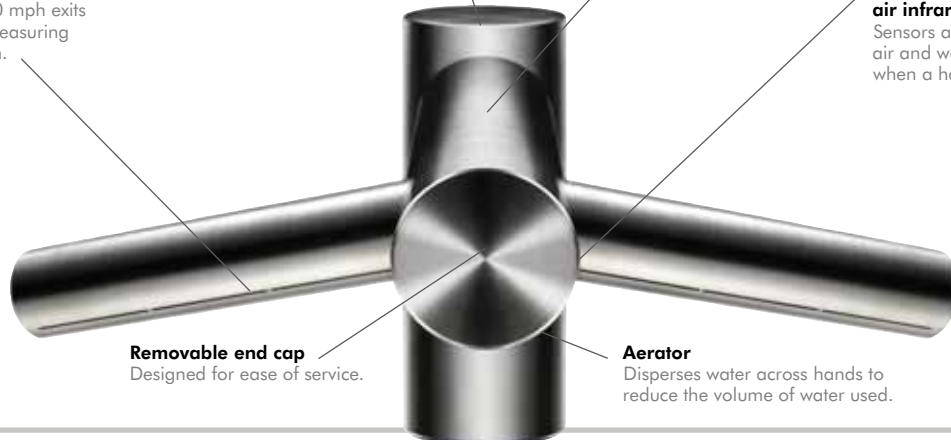

Removable end cap

Designed for ease of service.

Aerator

Disperses water across hands to reduce the volume of water used.



Dyson digital motor V4

Spins at 90,000rpm generating enough power to draw up to 35 litres of air per second through a HEPA filter.

Easy to service motor unit

Designed for quick disconnect.

Mains water inlet

Electronic, sensor-controlled water valve activates when a hand is detected. This starts the water flow.

Spring-mounted motor

Motor is mounted using springs to reduce sound and vibration.



HEPA filter

HEPA filter captures 99.9% of bacteria from the washroom air.

dyson airblade dB

AB
14

Suits all washrooms. Particularly recommended for areas where sound levels are an important consideration.



Grey



White

dyson airblade V

AB
08

Suitable for smaller washrooms or tighter spaces. It dries hands in 10 seconds.



Sprayed nickel



White

50% quieter. Acoustically re-engineered to reduce noise.

50% quieter

Improved acoustics compared to the original Dyson Airblade™ hand dryer. Scallop-shaped apertures reduce air rush noise and unpleasant motor tones have been minimised.

Fastest dry time – 10 seconds

Sheets of air travelling at 430 mph scrape water from the front and back of hands simultaneously.

The most hygienic hand dryer

A HEPA filter removes 99.9% of bacteria from the air used to dry hands.

Costs less to run

Dries 18 pairs of hands for the price of a single paper towel.¹

NSF approved

No other hand dryer meets every part of NSF Protocol 335.

HACCP approved

Certified hygienic for use in the food and beverage industry.



Small carbon footprint

Dyson Airblade™ hand dryers produce up to 72% less CO₂ than some other hand dryers and up to 68% less than paper towels.²

Touch-free operation

Infrared sensors operate air.

Antibacterial additive

Can help prevent the growth of bacteria.

Tough and durable

Robust, vandal-proof design.

Concentrated Airblade™ hand drying technology

Slim profile

Protrudes just four inches from the wall. No recessing required.

10 second dry time

Sheets of air travelling at 430 mph scrape water from hands like a windscreen wiper.

The most hygienic hand dryer

A HEPA filter removes 99.9% of bacteria from the air used to dry hands.

Costs less to run

Dries 17 pairs of hands for the price of a single paper towel!¹

NSF approved

No other hand dryer meets every part of NSF Protocol 335.

Small carbon footprint

Dyson Airblade™ hand dryers produce up to 72% less CO₂ than some other hand dryers and up to 68% less than paper towels.²

60% smaller

The same drying performance as the original Dyson Airblade™ hand dryer but 60% smaller.

Dries each hand separately

V-configuration separates hands, drying them quickly and evenly.

Touch-free operation

Capacitive sensors activate air.

Antibacterial additive

Can help prevent the growth of bacteria.

Easy to service

Safe electrical disconnect.

Quick to clean

Small surface area. Smooth single piece fascia with CNC-machined air slots.

¹ For calculations visit dysonairblade.co.uk/calcs

² Based on LCA results of Dyson Airblade™ hand dryers calculated by Dyson using method developed in conjunction with Carbon Trust, and comparable results from T. Montalbo, J. Gregory, R. Kirchain. Life Cycle Assessment of Hand Drying Systems (a Dyson commissioned study 2011). Data taken from U.S. environmental statistics including electricity grid mix and recycling practices and relating to models AB02 and AB04.

¹ For calculations visit dysonairblade.co.uk/calcs

² Based on LCA results of Dyson Airblade™ hand dryers calculated by Dyson using method developed in conjunction with Carbon Trust, and comparable results from T. Montalbo, J. Gregory, R. Kirchain. Life Cycle Assessment of Hand Drying Systems (a Dyson commissioned study 2011). Data taken from U.S. environmental statistics including electricity grid mix and recycling practices and relating to models AB02 and AB04.

dyson airblade tap

**AB
09** Short

Suitable for minimalistic washrooms, new or fully refurbished. It dries hands in 12 seconds.



**AB
10** Long



**AB
11** Wall



Visit dysonairblade.co.uk/tcad to download CAD drawings and see technical data

Airblade™ hand drying technology in a tap

Wash and dry hands at the sink

Water and air from the tap.

12 second dry time

Sheets of air travelling at 430 mph scrape water from hands like a windscreen wiper.

The most hygienic hand dryer

A HEPA filter removes 99.9% of bacteria from the air used to dry hands.

Costs less to run

Dries 15 pairs of hands for the price of a single paper towel.¹

NSF approved

No other hand dryer meets every part of NSF Protocol 335.

HACCP approved

Certified hygienic for use in the food and beverage industry.



Small carbon footprint

Dyson Airblade™ hand dryers produce up to 72% less CO₂ than some other hand dryers and up to 68% less than paper towels.²

No water on the floor

There's no need to leave the sink to dry hands, so water isn't dripped on to the floor.

Saves space

No separate hand drying area needed.

Touch-free operation

Intelligent infrared sensors activate water and air.

Saves water

Controlled water flow rate and sensor operation save water.

Easy to service

Quick to disconnect motor bucket and filter.

Quick to clean

Smooth stainless steel outer, wipes down directly over the sink – no separate hand dryers to clean.

¹ For calculations visit dysonairblade.co.uk/calcs

² Based on LCA results of Dyson Airblade™ hand dryers calculated by Dyson using method developed in conjunction with Carbon Trust, and comparable results from T. Montalbo, J. Gregory, R. Kirchain. Life Cycle Assessment of Hand Drying Systems (a Dyson commissioned study 2011). Data taken from U.S. environmental statistics including electricity grid mix and recycling practices and relating to models AB02 and AB04.

“As engineers we have to see beyond existing technology and ask ‘is there a better way?’ That’s really what Dyson is all about – new thinking to solve everyday problems.”

James Dyson
Inventor

dyson airblade

The fastest, most hygienic hand dryers.

For more information or
to find out how to buy:

Call: **0800 345 7788**

Visit: www.dysonairblade.co.uk



TESTED. CERTIFIED. HYGIENIC